

# MINIMUM GUIDELINES FOR AERIAL PHOTOGRAMMETRIC MAPPING

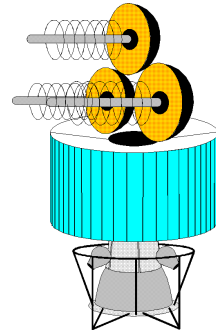
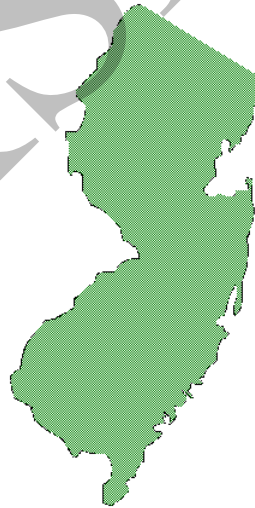
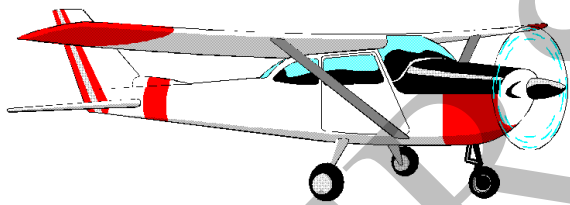
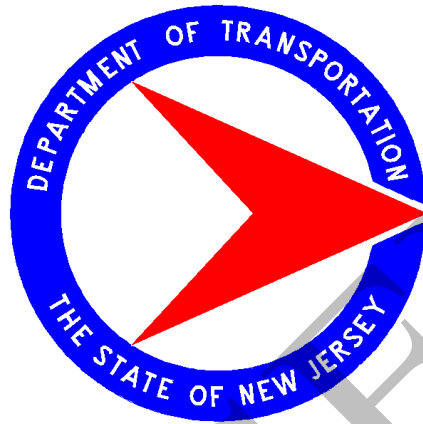

**BDC98PR-009**

*Issued By*

**QUALITY MANAGEMENT SERVICES  
CONFIGURATION MANAGEMENT**

*Technical Assistance By*  
**SURVEY SERVICES UNIT**

## TABLE OF CONTENTS

SECTION	PAGE
1. INTRODUCTION	
1-01 SCOPE AND APPLICATION	1-1
1-02 PROJECT AREA	1-1
1-03 FLYING PERIOD	1-1
1-04 NEGATIVES AND PHOTOGRAPHS	1-1
1-05 RESPONSIBILITY FOR CONTROL SURVEYS	1-2
1-06 BASIC DRAFTING REQUIREMENTS	1-2
1-07 PLAN INDEX	1-3
1-08 METHOD OF TESTING AND INSPECTION	1-3
1-09 COMPLETION TIME AND PRIORITIES	1-4
1-10 METHOD OF PAYMENT	1-4
2. AERIAL PHOTOGRAPHY	
2-01 AIRCRAFT AND CREWS	2-1
2-02 AERIAL CAMERA	2-1
2-02.1 Minimum Standards	2-1
a. Radial Distortion	2-1
b. Resolving Power	2-1
c. Principal Point of Autocollimation	2-1
d. Filter Parallelism	2-1
e. Magazine Platen	2-1
f. Stereo Model Flatness	2-2
g. Calibrated Focal Length	2-2
h. Shutter Calibration	2-2
2-02.2 Construction and Installation	2-2
2-02.3 Filter	2-2
2-02.4 Fiducial Marks	2-2
2-03 FILM	2-3
2-03.1 Film Type and Size	2-3
2-03.2 Exposure	2-3
2-03.3 Developing and Processing	2-3
2-03.4 Labeling	2-3
a. First and Last Exposure	2-4
b. Intermediate Exposure	2-4
2-04 PHOTOGRAPHY METHODS AND GUIDELINES	2-4
2-04.1 Flight Line	2-4
2-04.2 Weather and Sun Angle	2-4
2-04.3 Crab	2-4
2-04.4 Tilt	2-5
2-04.5 Overlap	2-5
a. Boundaries	2-5
b. Endlap	2-5

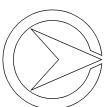

## TABLE OF CONTENTS

SECTION		PAGE
	c. Sidelap	2-5
	2-04.6 Quality of Photography	2-5
	2-04.7 Scale of Negatives	2-6
2-05	PHOTOGRAMMETRIC GROUND CONTROL	2-6
	2-05.1 Datum	2-6
	2-05.2 Ground Control Points	2-6
	2-05.3 Targeting Control Points	2-7
	2-05.4 Photo-identifiable Control Points	2-8
3.	PHOTOGRAPHIC PRINTS	
3-01	DESCRIPTION	
	3-1	
	3-01.1 Prints	3-1
	3-01.2 Types of Prints	3-1
3-02	MATERIALS	3-1
	3-02.1 Base Materials	3-1
	3-02.2 Photographic Emulsion	3-1
	3-02.3 Stability of Film and Paper	3-1
3-03	REQUIREMENTS	3-1
	3-03.1 Scale and Size	3-1
	a. Contact Prints	3-1
	b. Enlargements	3-2
	c. Reductions	3-2
	3-03.2 Processing Quality	3-2
	3-03.3 Selection	3-2
	3-03.4 Labeling	3-2
3-04	PHOTOGRAPHIC INDEX	3-2
	3-04.1 Photographic Paper and Film	3-3
	3-04.2 Assembly	3-3
	3-04.3 Labeling and Title Format	3-3
	3-04.4 Photographic Copying and Printing	3-4
	3-04.5 Size and Scale	3-4
3-05	FURNISHING AND DELIVERY	3-4
4.	GROUND SURVEYS FOR PRIMARY CONTROL	
4-01	GENERAL DESCRIPTION	4-1
4-02	MATERIALS AND EQUIPMENT	4-1
4-03	LIAISON	4-1
4-04	GROUND CONTROL	4-1
	4-04.1 Permanent Monuments or Survey Station Markers	4-2
	a. Materials	4-2
	b. Control	4-3
	4-04.2 Survey Bench Marks	4-4

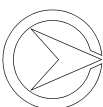

## TABLE OF CONTENTS

SECTION		PAGE
	a. Materials	4-4
	b. Control	4-5
4-04.3	Semi-permanent Survey Station Markers	4-5
	a. Materials	4-5
	b. Control	4-6
4-04.4	Primary Horizontal Control	4-6
4-04.5	Primary Vertical Control	4-10
4-05	SURVEY TRAVERSE FOR CADASTRAL SURVEYS	4-12
4-06	LOCATING MONUMENTS ON MAPS	4-12
4-07	SUPPLEMENTAL CONTROL SURVEYS	4-12
	4-07.1 Horizontal Control	4-13
	4-07.2 Vertical Control	4-13
	4-07.3 Supplemental Photo Control	
	-- Analytical Aerotriangulation	4-13
4-08	DOCUMENTATION	4-14
	4-08.1 Field Notes	4-14
	4-08.2 Control Report	4-15
	a. Narrative	4-15
	b. Control Diagram	4-15
	c. Computations	4-16
4-09	GLOBAL POSITIONING SURVEYING SYSTEM	4-16
	4-09.1 General	4-16
	4-09.2 GPS Survey Standard and Specifications	4-17
	a. GPS Survey Standards	4-17
	b. Network Design and Geometry Specifications	4-18
	c. Instrumentation Specifications	4-19
	d. Calibration Specifications	4-19
	e. Field Survey Procedures	4-19
	f. Office Procedure Specifications	4-20
	g. Analysis and Adjustments	4-21
5.	PHOTOGRAMMETRIC MAPPING	
5-01	COMPILATION	5-1
	5-01.1 General	5-1
5-02	AREA	5-1
5-03	MAP MANUSCRIPT	5-1
5-04	TOPOGRAPHIC MAPS FOR DESIGN	5-2
	5-04.1 Plane Coordinate Grid Lines	5-2
	5-04.2 Matchlines, Title Blocks and North Arrows	5-2
	5-04.3 Current Data	5-2
	5-04.4 Planimetry	5-2
	5-04.5 Topographic Details	5-5
	a. Contours	5-6

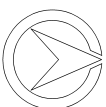

## TABLE OF CONTENTS

SECTION		PAGE
	b. Spot Elevations	5-6
	c. Underground Utilities	5-6
	d. Drainage	5-6
5-04.6	Plan Production Specifications	5-7
	a. Layout Prerequisites	5-7
	b. Contours	5-7
	c. Lettering	5-8
	d. Inspection and Editing	5-8
5-04.7	Finished Maps	5-8
5-04.8	Index Maps	5-9
5-05	MAP ACCURACY SPECIFICATIONS	5-9
5-05.1	Horizontal Accuracies	5-9
	a. Planimetry	5-9
	b. Grid Lines	5-9
	c. Horizontal Control	5-10
5-05.2	Vertical Accuracies	5-10
	a. Contours	5-10
	b. Spot Elevations	5-10
5-05.3	Special Requirements	5-10
6.	DIGITAL TERRAIN MODELS	
6-01	GENERAL	6-1
6-02	TYPES OF DIGITAL TERRAIN MODELS	6-1
	6-02.1 Grid	6-1
	6-02.2 Cross Sections	6-1
	6-02.3 Re-measurement	6-1
	6-02.4 Critical Points	6-1
6-03	DESCRIPTION OF THE DIGITAL TERRAIN MODELS	6-1
	6-03.1 Type	6-1
	6-03.2 Area	6-2
6-04	REQUIREMENTS FOR MAP COMPILATION BY THE USE OF DIGITAL PHOTOGRAMMETRIC METHOD.	6-2
6-05	ACCURACY	6-3
6-06	SELECTION OF LIMITS FOR THE PROPER ROOT-MEAN-SQUARE-ERROR FOR DIGITAL TERRAIN MODEL	
	6-3	
6-07	ACCEPTANCE	6-4
7.	MAP DETAILS	
7-01	ONE TO TWO THOUSAND SCALE, TWO METER CONTOURS	7-1
	7-01.1 Scale	7-1
	7-01.2 Map Manuscript Requirements	7-1
	7-01.3 Contents	7-1

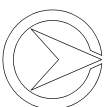

## TABLE OF CONTENTS

SECTION		PAGE
	a. General	7-1
	b. Drainage	7-2
	c. Relief	7-2
	d. Coordinates	7-2
7-01.4	Accuracies	7-2
	a. Cultural Features	7-2
	b. Contours	7-3
	c. Spot Elevations	7-3
7-02	ONE TO ONE THOUSAND SCALE, ONE METER CONTOURS	7-3
7-02.1	Scale	7-3
7-02.2	Map Manuscript Requirements	7-3
	a. General	7-3
	b. Drainage	7-4
	c. Wooded Areas	7-4
	d. Relief	7-4
	e. Coordinates	7-4
7-02.3	Accuracies	7-5
	a. Cultural features	7-5
	b. Contours	7-5
	c. Spot Elevations	7-5
7-03	ONE TO FIVE HUNDRED SCALE, HALF METER CONTOURS, AND ONE TO THREE HUNDRED SCALE, HALF METER CONTOURS	7-5
7-03.1	Scale	7-5
7-03.2	Map Manuscript Requirements	7-5
	a. General	7-6
	b. Drainage	7-7
	c. Wooded Areas	7-7
	d. Relief	7-7
	e. Coordinates	7-8
7-03.3	Accuracies	7-8
	a. Cultural Features	7-8
	b. Contours	7-8
	c. Spot Elevations	7-8
7-04	STANDARD ACCURACIES FOR PHOTOGRAMMETRIC MAPPING	7-9
8.	DELIVERY AND PAYMENT	
8-01	MATERIALS TO BE DELIVERED	8-1
8-02	PERFORMANCE SCHEDULE	
	8-1	
8-03	BASIS FOR PAYMENT	8-1
9.	GLOSSARY	9-1

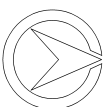

## TABLE OF CONTENTS

<b>SECTION</b>		<b>PAGE</b>
10.	APPENDIX	
	APPENDIX A FEDERAL GEODETIC CONTROL COMMITTEE MEMBERSHIP	10-1
	APPENDIX B ONE DIMENSIONAL AND THREE DIMENSIONAL (ELLIPSOIDAL AND SPHERICAL) ERRORS	10-2
	APPENDIX C CONVERSION OF MINIMUM GEOMETRIC ACCURACIES AT THE 95 PERCENT CONFIDENCE LEVEL FROM FIGURE 4-5 TO MINIMUM "ONE SIGMA" STANDARD ERRORS	10-3
	APPENDIX D EXPECTED MINIMUM/MAXIMUM ANTENNA SETUP ERRORS	10-4
	APPENDIX E ELEVATION DIFFERENCE ACCURACY STANDARDS FOR GEOMETRIC RELATIVE POSITIONING TECHNIQUES	10-5
	APPENDIX F PLANNING THE GPS SURVEY OBSERVING SCHEDULE	10-7
	APPENDIX G EXAMPLES OF GPS SURVEYS WITH SUMMARY OF STATISTICS USED TO CLASSIFY THE ORDER OF SURVEY BASED ON THE OBSERVING SCHEME AND DATA COLLECTION PROCEDURES (EXAMPLES 1 TO 4)	10-9
	APPENDIX H SPECIFICATIONS AND SETTING PROCEDURES FOR THREE-DIMENSIONAL MONUMENTATION	10-13

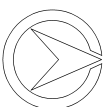

## SECTION 1

### INTRODUCTION

#### 1-01 SCOPE AND APPLICATION

Photogrammetry consists of the accurate measurement of man-made and natural land features through the production and use of aerial photographs and can be supplemented by field-edited surveys which compensate for information not otherwise revealed by the photographs.

Once the photographs and related information become available, original map manuscripts can be compiled and final-drafted as maps, plans, related specialized drawings or other graphic representations of land features at the intended scales and contour intervals.

#### 1-02 PROJECT AREA

Each project area shall be delineated on a United States Geologic Survey (USGS, also known as Quad Map ) sheet; or comparable keymap to include the breadth and length of the project and its relationship to the surrounding terrain.

A twenty - five millimeters (25 MM) wide band at the final map scale encompassing the project area shall also be compiled to insure complete coverage of the area.

#### 1-03 FLYING PERIOD

Aerial photography shall be undertaken only when well-defined images can be obtained. Photography shall not be attempted when the ground is obscured by haze, snow, foliage, flooding conditions or when clouds or cloud shadows would appear on more than five (5) percent of the area of any one photograph. At the time of year during which aerial photographs must be taken, shadows caused by topographic relief and low sun angle shall be avoided whenever possible. Aerial photography shall not be undertaken when the angle is less than thirty (30) degrees above the horizon.

#### 1-04 NEGATIVES AND PHOTOGRAPHS

All photographic negatives shall become the property of the State of New Jersey, Department of Transportation (NJDOT). All photographs shall be clear, sharp, free of blemishes and of good quality in all respects. The scale, date, and project identification shall be evident thereon, and identifying numbers in sequence shall be indicated on all photographs.

The Contractor shall furnish two (2) sets of photographic contact prints on resin-coated paper showing sufficient overlap for stereoscopic study of the project area.

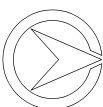



The Contractor shall likewise furnish any additional photographic reproductions so designated by the NJDOT upon examination of the contact prints.

The Contractor shall furnish two (2) copies of a photographic index map of each project area, printed on resin-coated paper, to permit selections of prints on any part of the project in question.

#### **1-05 RESPONSIBILITY FOR CONTROL SURVEYS**

The Contractor shall provide all materials, supplies, equipment and qualified personnel required for the satisfactory completion of all control surveys to the accuracy and precision stipulated by the NJDOT. Unless stated otherwise, all field and office work shall be done by the Contractor, and only Professional Land Surveyors licensed by the State of New Jersey, Department of Law and Public Safety, Division of Consumer Affairs, Board of Professional Engineers and Land Surveyors, shall be authorized to perform and supervise complete control surveys.

Each survey tape, leveling rod and precision instrument, i.e. theodolite, level, electronic distance measuring device, global positioning system instrument, etc., shall have been calibrated within the past year. Calibration tests and results shall be submitted to the NJDOT upon request.

#### **1-06 BASIC DRAFTING REQUIREMENTS**

All maps and plan sheets shall be produced on tracing sheets made of dimensionally stable polyester-type plastic transparent film having a minimum thickness of one tenth of a millimeter (0.10 MM). Every feature and detail plotted thereon shall be sufficiently clear and accurate so that all subsequent reproductions will show clearly legible nomenclature and symbol definition at the prescribed scale.

The Contractor shall compile all planimetry and topography stipulated by the NJDOT onto map manuscripts by stereophotogrammetric methods at the direct scale and contour interval prescribed by the NJDOT. The symbols used to represent planimetric and topographic features shall be in accordance with Figures 1-1A, 1-1B, 1-1C, and 1-2.

The map manuscripts shall be available for inspection by the NJDOT at all times, and they shall be delivered to the NJDOT for field-editing and the incorporation of any additional planimetric detail.

The Contractor shall obtain and neatly render on the maps the current names and political subdivision or corporate lines of any adjoining states and all concerned counties and municipalities. Also required are the current designations of all Federal, State and County roadways and the names of prominent bodies of water such as rivers and lakes. In addition to being legible and clear in meaning, all names and numbers so rendered shall not interfere with map features.

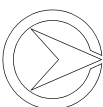

On projects with flights east and west, map sheets and plan sheets shall commence from the west and progress eastward. On projects with flights north and south, map sheets and plan sheets shall commence from the south end and progress northward.

## **1-07 PLAN INDEX**

The Contractor shall prepare an index of maps or plan sheets on tracing sheets made of plastic film as prescribed in Section 3-02.1. The index shall show the positions and relationships of all maps or plan sheets superimposed over a drawing or composite photograph of the entire project. Sufficient data shall be indicated on the index to permit selection of individual sheets.

## **1-08 METHOD OF TESTING AND INSPECTION**

The Contractor shall submit two complete sets of computations and adjustments of all ground control data to the NJDOT for review by the NJDOT before the analytical solution for stereo compilation is begun. Submissions shall be in both hard and computer floppy diskette or compact disk formats. Computer diskettes or compact disks (CD's) must be 100% NJDOT compatible. The NJDOT shall advise the Contractor of approval or rejection within the thirty (30) calendar days after receipt of the computations by the NJDOT.

The Contractor shall submit three (3) black-line or blue-line white check prints of each completed final map tracing sheet for review. The NJDOT will direct, at its discretion, either in-house personnel or the outside Consultant contracted by NJDOT to prepare the formal plans, specifications and estimates, if other than the Contractor, to: (1) field-inspect and test the submitted check prints for completeness of planimetry or topography, and (2) ensure general conformance with Section 5 and specific conformance with Section 7 at the applicable scales. Contour accuracy will be tested by taking elevations of points crossed by a field traverse. In all cases, the NJDOT reserves the right to select the areas to be tested. The required field inspections and conformance checks shall have priority to be accomplished as promptly as possible.

When a tracing sheet or check print is rejected based upon its percent of error being greater than the allowable value as stipulated by these Specifications, the Contractor shall review and revise the sheet as required to bring it within the permitted tolerance.

For either the initial or subsequent submissions, the NJDOT shall be allowed sixty (60) calendar days for each sheet after the receipt of the check prints for review. The Contractor shall be notified of approval or rejection with this period. If any sheet is rejected, the Contractor shall upgrade it to an acceptable level of accuracy and shall submit three (3) additional prints as before, at his own expense, within thirty (30) calendar days after notification or rejection. After the initial review and rejection, all additional field inspections, tests or other checks made by the NJDOT will be at the Contractor's expense at the rate of four hundred dollars (\$400) per sheet for each additional rejection and subsequent check. All required corrections and resubmitted check prints shall be at the Contractor's expense.

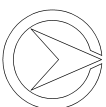

The Contractor shall deliver tracing sheets by items or sub-items when notified of final approval of all tracing sheets by the NJDOT except that, upon special NJDOT requests, the Contractor shall deliver a particular tracing sheet of an approved map or plan sheet.

## **1-09 COMPLETION TIME AND PRIORITIES**

Contact photographs and indexes shall be delivered to the NJDOT within ten (10) calendar days after the flying period shown on the Proposal form and Contract, given permissible flying conditions. Failure to complete flying of all items and sub-items within the flying period, without advance written authorization, shall be cause for annulment of the Contract.

Unless stipulated otherwise by the NJDOT, the Contractor shall produce and submit check prints of the first six (6) final map tracing sheets in sequence to the NJDOT within seventy-five (75) calendar days of the last day of the flying period. Additional check prints must be submitted at the rate of ten (10) sheets over forty-five (45) calendar days thereafter. Where two or more items are combined in one contract, time allowed will be figured either consecutively or by priority unless specified otherwise by the NJDOT.

If the flight of any item is subjected to an authorized delay beyond the flight period for any reason, the last day of the flying period shall, nevertheless, be considered the final date for determining photograph and map delivery dates.

All remaining negatives shall be delivered to the NJDOT within thirty (30) calendar days after complete acceptance of all maps covered by the Contract.

## **1-10 METHOD OF PAYMENT**

Payment shall consist of full compensation for all work completed and accepted by the NJDOT, for defrayal of all fees and other costs, for performance of extra work and alterations ordered by the NJDOT, and for submission and delivery to the NJDOT according to the Proposal form, the Contract, and any subsequent Addenda and Change Orders. The Contract-specified unit price times the actual quantity of each pay item accepted by the NJDOT, or the lump sum of each pay item accepted by the NJDOT, or the force account basis when applicable and authorized by the NJDOT, shall constitute the basis for payment.

The Contractor may request partial payments for work performed on items with lump sum prices. These requests may be submitted monthly and shall be made on voucher forms supplied by the NJDOT. Upon approval, payment shall then be meted out by the NJDOT on the following basis:

- Partial payments shall be equal to ninety percent (90%) of the amount arrived at by multiplying the percentage of work performed to date under the Contract by the lump sum price. The work performed to date shall be recounted in a progress report prepared by the Contractor and submitted to the NJDOT for approval.

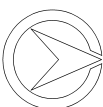

- Final inspection of materials received from the Contractor will be made by the NJDOT within ten (10) calendar days after the delivery date. Upon acceptance, the Contractor will be so notified in writing. The Contractor will then be authorized thereby to submit his final voucher.

SUPERSEDED

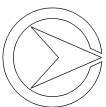

FIGURE 1-1A: NJDOT STANDARD LEGEND

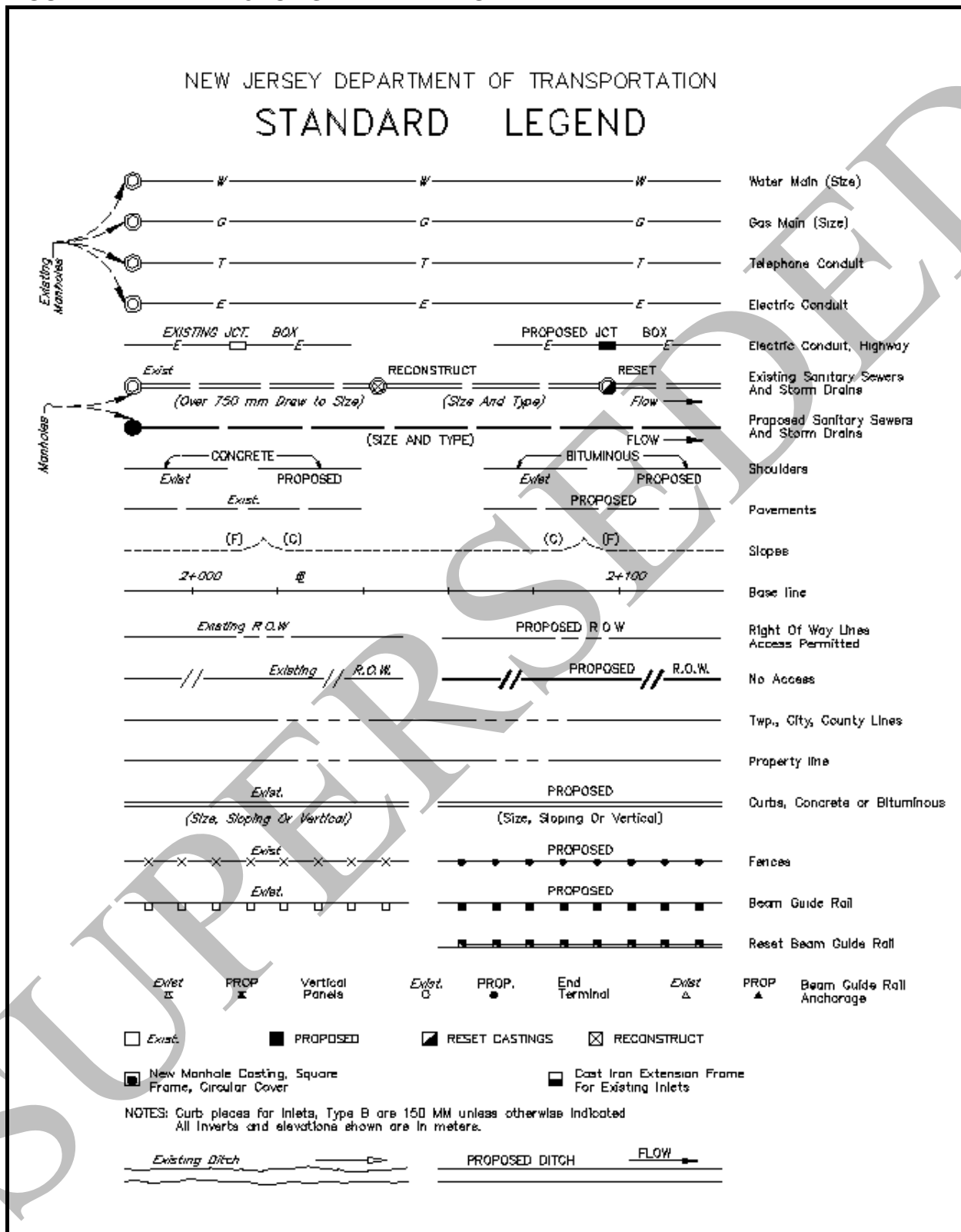

FIGURE 1-1B: NJDOT STANDARD LEGEND (CONT.)

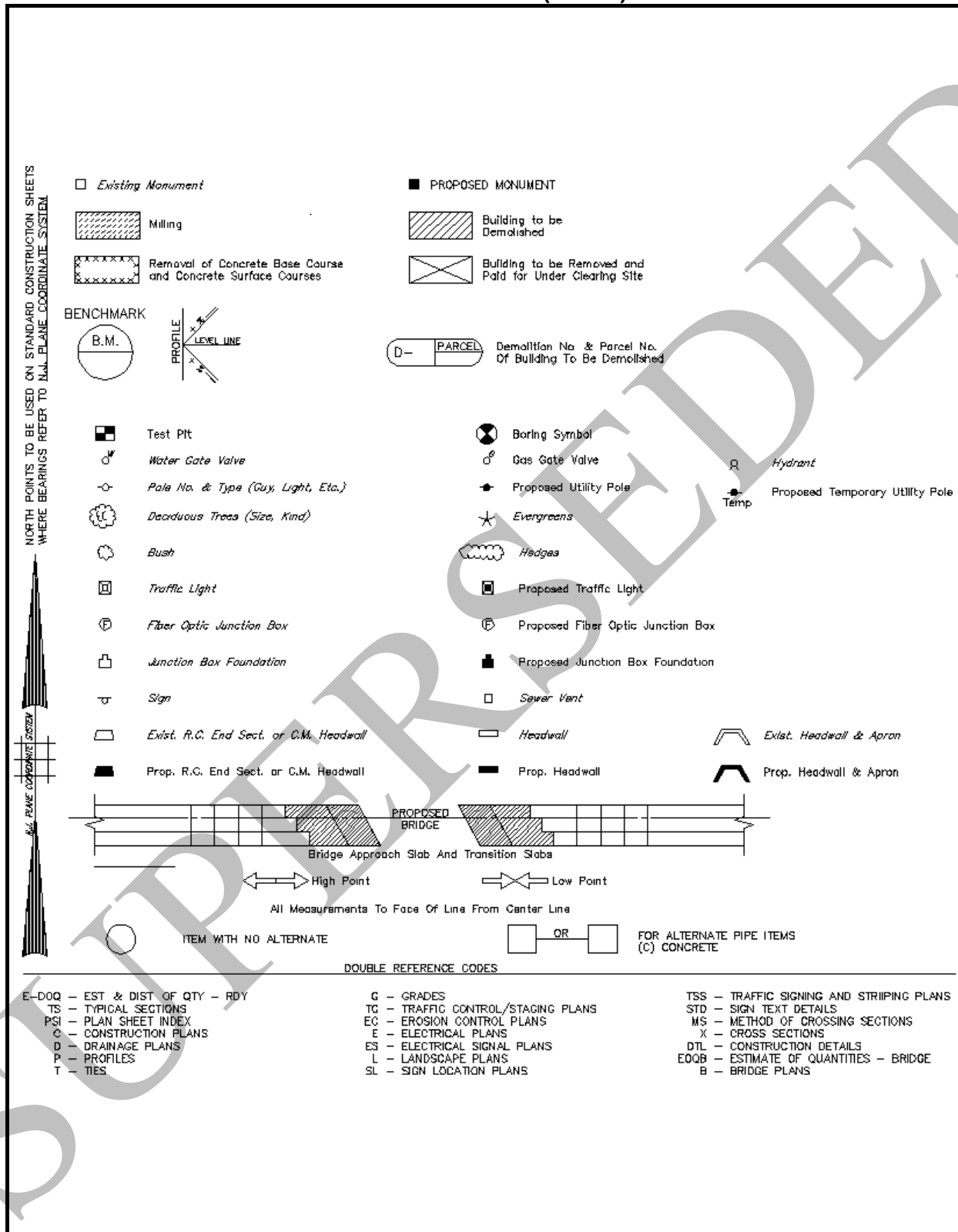



















FIGURE 1-1C: NJDOT STANDARD LEGEND (CONT.)

## GENERAL NOTES AND ABBREVIATIONS

A	ALUMINUM	MM	MILLIMETER
AB	ABOVE	MON	MONUMENT
AHD.	AHEAD	MP	MILEPOST
AVE.	AVENUE	N	NORTH, NEWTON
B	BASELINE	N/N	NO NUMBER
B.M	BENCH MARK	N/F	NOW OR FORMERLY
B.T.	BELL TELEPHONE	N.J.	NEW JERSEY
BIT.	BITUMINOUS	NB	NORTHBOUND
BK	BACK	NO.	NUMBER
BLDG	BUILDING	NTS	NOT TO SCALE
BSBC	BITUMINOUS STABILIZED BASE COURSE	PC	POINT OF CURVATURE
C	CENTERLINE	PCC	POINT OF COMMON CURVATURE
C	CUT	PERF	PERFORATED
(C)	CONCRETE- WHEN USED IN ALTERNATE ITEMS	PGL	PROFILE GRADE LINE
C.M.	CUBIC METER	PK	NAIL IN PAVEMENT
CAP	CORRUGATED ALUMINUM PIPE	PCC	POINT ON CURVE
CB	CATCH BASIN	POL	POINT ON LINE
CC	CENTER OF CURVE	POT, P.O.T.	POINT ON TANGENT
CFP	CAST IRON PIPE	PROP.	PROPOSED
CLF	CHAIN LINK FENCE	PT	POINT OF TANGENCY
CMP	CORRUGATED METAL PIPE	PVC	POLYVINYL CHLORIDE PIPE, POINT OF VERTICAL CURVATURE
CO.	COMPANY CELSIUS	PI	POINT OF VERTICAL INTERSECTION
°C	CELSIUS	PVT	POINT OF VERTICAL TANGENCY, PAVEMENT
CONC.	CONCRETE	R	RADIUS
COR.	CONCRETE CORNER	RCCP	REINFORCED CONCRETE CULVERT PIPE
QULV.	QULVERT	ROP	REINFORCED CONCRETE PIPE
*+* CUT	CROSS-CUT	RD	ROAD
D	DIAMETER	REN	REMOVE
D.C., D/C	DROP CURB	RMC	RIGID METALLIC CONDUIT
DE	DITCH EXCAVATION	RNMG	RIGID NON-METALLIC CONDUIT
DEP.	DEPRESSED	ROW, R O W	RIGHT OF WAY
DHV	DESIGN HOURLY VEHICLE	RT	ROUTE, RIGHT
DIST.	DISTANCE	S	TURNER LINE
DWY	DRIVEWAY	S	SOUTH, SEWER, SECOND
E	EAST, EXTERNAL	S/W, SDWK	SIDWALK
EA	END ANCHOR	S.M.	SQUARE METER
EB	EASTBOUND	SAN.	SANITARY SEWER
EL_ELEV	ELEVATION	SB	SOUTHBOUND
ELEC	ELECTRIC	SC	STRIP IN CUT
ELT	ECCENTRIC LOAD TERMINAL	SF	STRIP IN FILL
EQ.	EQUATION	SFCO	SQUARE FRAME CIRCULAR COVER
ESMT.	EASEMENT	SHD	STATE HIGHWAY DEPARTMENT
EXIST.	EXISTING	SHLDR.	SHOULDER
F	FILL	SOD	SUBBASE OUTLET DRAIN
FR	FRAME	ST	STREET
FT	FEET	STY.	STORY
F.H.	FIRE HYDRANT	T	TANGENT
G	GAS	T.G.	TOP OF GRADE
G.R	GUIDE RAIL	T.R.	TOP OF RIM
GAL	GALLON GRATE	TBA	TO BE ABANDONED
GR.	GRATE	TBR	TO BE REMOVED
GRD	GROUND	TBL	TELEPHONE
GV	GAS VALVE	TEMP.	TEMPORARY
H	HOUR	THK., TH.	THICK
HA	HECTARE	TS	TOPSOIL
HT.	HEIGHT	TYP	TYPICAL
H W	HEAD WALL	U.D.	UNDERDRAIN
HYD.	HYDRANT	UP, U.P.	UTILITY POLE
INV.	INVERT	VAR.	VARIABLE, VARIES
JB	JUNCTION BOX	VPO	VEHICLES PER DAY
JBF	JUNCTION BOX FOUNDATION	W	WEST, WATER
KG	KILOGRAM	WB	WESTBOUND
KM	KILOMETER	WE	WET EXCAVATION
KMP	KILOMETER POST	WM	WATER METER
KPA	KILOPASCAL	WV	WATER VALVE
L	LENGTH, LITER	X-SECT	CROSS SECTION
L.M	LINEAR METER		
L.P.	LIGHT POLE		
LB	POUND		
LOP	LIMIT OF PAVEMENT		
LT	LIGHT, LEFT		
M	METER		
(M)	METAL - WHEN USED IN ALTERNATE ITEMS		
M.B	MAILBOX		
MG	MEGAGRAM		
MH, N.H.	MAN HOLE		
MIN.	MINIMUM		
ML	MILLILITER		

FIGURE 1-2: SUPPLEMENTAL SYMBOL LEGEND

THE FOLLOWING SYMBOL LEGEND IS PROVIDED TO SUPPLEMENT  
 THE NJDOT STANDARD LEGEND IN THE COMPILATION  
 OF MAP MANUSCRIPTS AND FINAL PLAN

	CATCH BASIN		DROP INLET
	FIRE ALARM BOX		FLAGPOLE
	LAMP POST (PVT.)		LIGHT POLE
	MAILBOX		MANHOLE / CATCH BASIN
	PARKING METER		POLICE ALARM BOX
	POST		POWER LINE
	RAILROAD		RAILROAD CROSSING
	SIGN		SWAMP
	TELEPHONE		TRAFFIC CONTROL TREAD

ROUTE MARKER DESIGNATIONS

	STATE ROUTE		COUNTY ROUTE
	U.S. ROUTE		KM MARKER POST
	INTERSTATE ROUTE		

PRIMARY CONTROL DESIGNATIONS

PHOTO CENTER

2-53



CONTROL, MONUMENT

△ MON G-63  
 N 201 303.048  
 E 157 404.806  
 (NAD 83)

CONTROL, BENCHMARK

× BM - 4  
 EL. 215.700  
 (NAVD 88)



## SECTION 2

### AERIAL PHOTOGRAPHY

#### 2-01 AIRCRAFT AND CREWS

The aircraft shall be maintained and operated in accordance with the regulations of the Federal Aviation Administration and the Civil Aeronautics Board. The overall aircraft performance shall be adequate for the satisfactory completion of all photography items and sub-items stipulated by the Proposal form and Contract and according to the guidelines and accuracies contained in these Specifications.

Crews having a minimum 400 hours experience in flying precise photographic missions for aerial surveys shall be used. In addition, each crew shall have prior experience (50 hours minimum) with the same type of aircraft to which the crew is assigned.

#### 2-02 AERIAL CAMERA

##### 2-02.1 Minimum Standards

Each camera and its corresponding magazines shall have been calibrated, tested, and certified by the camera manufacturer or by a calibration center, recognized internationally or approved by the camera manufacturer within the past three (3) years. The contracted aerial firm must provide the most recent calibration dates for its equipment for each project. However, when there is any reason to believe that the dimensional relationship of the lens, fiducial marks, and film have been disturbed by partial disassembly or unusual mechanical shock, the camera must be submitted for recalibration at the contractor's expense.

Any camera used on a project shall meet the following minimum standards as set forth by the USGS Calibration Certificate:

- a. Radial Distortion: Average distortion for a given field angle is ten (10) microns or less.
- b. Resolving Power: Area weighted average resolution is sixty (60) cycles per millimeter or greater.
- c. Principal Point of Autocollimation: Lines joining pairs of fiducial (collimation) marks shall intersect at an angle of ninety degrees ( $90^{\circ}$ ), plus or minus thirty seconds ( $30''$ ) of arc, and that intersection shall indicate the true location of the principal point of autocollimation within twenty-five (25) microns or less.
- d. Filter Parallelism: The two surfaces of all filters used on the camera shall be parallel to within ten seconds ( $10''$ ) of arc.
- e. Magazine Platen: The platens of all camera magazines shall not depart from a true plane by more than thirteen (13) microns; that is, thirteen thousandths of a millimeter (0.013 MM).
- f. Stereo model Flatness: No test point in the stereo model shall have an average departure from flatness of more than twenty-five (25) microns at negative scale.

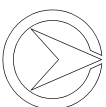

The stereo model flatness test results shall be provided for all camera-magazine combinations upon request.

- g. Calibrated Focal Length: The measurement of calibrated focal length shall be accurate to within five (5) microns.
- h. Shutter Calibration: Shutter efficiency shall be at least seventy-five percent (75%). Shutter speeds shall be accurate to within ten percent (10%) of indicated value.

## 2-02.2 Construction and Installation

Only rigidly constructed, single lens, precision cartographic cameras exposing 230 MM x 230 MM negatives, having a nominal focal length of one hundred fifty three (153) millimeters, shall be used. The camera shall be equipped with a between-the-lens-elements shutter and a vacuum or pressure device for holding the film flat at the instant of exposure. The camera must produce at least four (4) fiducial (reference) marks on each negative for accurately locating the principal point of the photograph. A total of eight (8) such marks (one in each corner and one on each side of the photographic exposure area) is preferable.

The camera shall be mounted on the aircraft so that all parts are within the outer structure and that the camera is permitted an unobstructed view. The viewing field shall be shielded from gases, oil, and air turbulence, but no window of glass, plastic or other material shall be interposed between the camera lens and the ground to be photographed.

## 2-02.3 Filter

An appropriate light filter with an antivignetting metallic coating shall be used. The two surfaces of the filter shall be parallel to within ten seconds (10") of arc. The optical characteristics of the filter shall be such that its addition and use shall not cause any unacceptable reduction in image resolution, and they shall not detrimentally alter the optical characteristics of the camera lens.

## 2-02.4 Fiducial Marks

A minimum of four (4) fiducial marks shall be shown, one at each corner of the format, and they shall be integral parts of the lens cone assembly. A total of eight (8) such marks is preferable with each mark of the second quartet appearing at the midpoint of each side of the format.

All fiducial marks shall produce well-defined images in aerial negatives and on calibration plates so as to permit point-plotting on the images with a precision of twenty-five (25) microns or less.

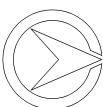

## 2-03 FILM

### 2-03.1 Film Type and Size

Only a fine grain, high sensitivity, high intrinsic resolving power photographic emulsion on dimensionally stable safety film base shall be used. Outdated film shall not be used. Unexposed and exposed film shall be stored, handled and processed in accordance with the manufacturer's guidelines. The film shall be suitable for photographic reproductions with sufficient stereoscopic overlap for use in precision photogrammetric instruments to compile planimetric and/or topographic maps and to measure profile and cross section elevations and heights by photogrammetric means.

The film shall yield an image area of two hundred thirty millimeters by two hundred thirty millimeters (230 MM x 230 MM) for each exposed negative. The leader length and trailer length shall not be less than two meters (2 M) and one meter (1 M) respectively.

### 2-03.2 Exposure

Film exposure shall be in accordance with the manufacturer's guidelines. The negatives shall be free from light streaks and static marks, and they shall have uniform tone and a degree of contrast permitting land features and ground details to show clearly in dark and light areas and especially so with respect to legibility in shadow areas. Negatives which fail to meet the above requirements may be considered unsatisfactory and be subject to rejection.

### 2-03.3 Development and Processing

Each roll of film shall be processed as soon as possible after it is exposed. Special care shall be taken to insure proper development and thorough fixing and washing in accordance with the film manufacturer's guidelines.

Film shall not be wound tightly on drums and shall not be stretched, shrunk or distorted in any way during processing or drying. Film shall be free from finger marks, dirt or blemishes of any kind. Such defects and flaws, which, in the opinion of the NJDOT, would interfere with the film's intended purpose, shall be cause for rejection.

### 2-03.4 Labeling

All exposures shall be labeled to read easily from left to right. The labeling shall be oriented so as to be read in the direction from project beginning to project end.

All lettering and numbering shall be legible and uniform in presentation and shall be rendered in symbols and characters five (5) millimeters in height and shall be executed as follows:

- a. First and Last Exposures: The first and last exposures shall be labeled as follows:

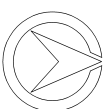

- In the upper left-hand corner: Date of exposure, time, focal length, RF scale, and the flight height of the camera (aircraft) above the mean ground elevation or some set datum such as the North American Vertical Datum of 1988 (NAVD 88).
  - In the upper right-hand corner: Project number, flight line number, and the identifying number of the exposure itself.
- b. Intermediate Exposures: All intermediate exposures shall be identified in the direction from project beginning to project end. Exposures shall be labeled in the upper right-hand corner as follows:
- Project number, flight line number, and the identifying number of the exposure itself.

The Contractor shall furnish the negative on spools in suitable containers. Each container shall be labeled to show the corresponding municipalities and counties, the legislated route designation, photographic scale, date of exposure, and any applicable aerial number on the first and last exposure of each strip.

## **2-04 PHOTOGRAPHY METHODS AND GUIDELINES**

### **2-04.1 Flight Line**

The Contractor shall design the flight lines to insure full stereoscopic photographic coverage. In general, flight lines shall be parallel to each other and to the lengthwise boundary lines of the areas to be photographed.

### **2-04.2 Weather and Sun Angle**

Aerial photography shall be undertaken only when well-defined images can be obtained. Photography shall not be undertaken when the ground is obscured by haze, snow, foliage, flooding conditions, or when clouds or cloud shadows would appear on more than five percent (5%) of the area of any one photograph.

Aerial photography shall not be undertaken when the sun angle is less than thirty degrees ( $30^{\circ}$ ) above the horizon. Shadows caused by topographic features and sun angle shall be cause for rejection.

### **2-04.3 Crab**

Crab shall not exceed three degrees ( $3^{\circ}$ ) in any negative. Any two or more consecutive photographs displaying crab in excess of five degrees ( $5^{\circ}$ ) shall be rejected.

### **2-04.4 Tilt**

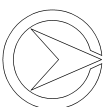

Tilt shall not exceed four degrees ( $4^{\circ}$ ) in any negative. Any two or more consecutive photographs displaying tilt in excess of five degrees ( $5^{\circ}$ ) are unacceptable. Throughout the entire project, the average amount of tilt shall not exceed one degree ( $1^{\circ}$ ). Any tilt in excess of the above criteria shall be cause for rejection.

#### 2-04.5 Overlap

Overlap shall be sufficient to provide full stereoscopic coverage of the areas to be photographed. Where there is a change in direction of the flight line(s), photographs taken at the beginning of the next flight line or segment of the same flight line shall give complete stereoscopic coverage of the area contiguous to the forward and back sections.

Overlap shall be provided as follows:

- a. Boundaries: All the area appearing on the first and last negative in each flight line or flight line segment extending over a boundary shall be outside the boundary of the project area. Each strip of photographs shall extend over the boundary not less than fifteen percent (15%) or more than fifty-five percent (55%) of the strip width.
- b. Endlap: Endlap shall average not less than fifty-seven percent (57%) nor more than sixty-two percent (62%). Endlap of less than fifty-five percent (55%) or more than sixty-eight percent (68%) in one or more negatives may be cause for rejection. However, consideration shall be given if, in the case of a stereoscopic pair, endlap exceeding sixty-eight percent (68%) was found to be unavoidable in areas of low elevation in order to attain the fifty-five percent (55%) minimum endlap in adjacent areas of higher elevation.
- c. Sidelap: Sidelap shall average thirty percent (30%), plus or minus ten percent (10%). Any negative having sidelap less than fifteen (15%) or greater than fifty percent (50%) may be rejected. However, consideration shall be given if the strip area to be mapped is found to be slightly wider than the area which can be covered in one flight strip. In that case, sidelap of up to seventy percent (70%) to take advantage of control is permissible.

#### 2-04.6 Quality of Photography

Photography shall be executed so as to minimize image movement at the moment of exposure. Such exposure and the subsequent processing shall be such that all negatives shall be of high quality showing all specified planimetric and topographic features at the scale stipulated by the NJDOT.

Negatives which are not clear and sharp in detail and in average contrast, and which are not free from static marks, stains and other blemishes which, in the opinion of the NJDOT, would interfere with their intended purpose, shall be rejected.

#### 2-04.7 Scale of Negatives

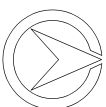

The flight height above the average ground elevation or set datum shall be such that the negatives will yield photographic prints on paper or on dimensionally stable polyester-type plastic or on optically flat glass plates to the scale specified by the NJDOT. Negatives departing from the intended scale by more than five percent (5%) shall be rejected.

Unless specified otherwise by the NJDOT, the flight height shall be six times the value of the intended aerial negative scale. Accordingly, the photography (negative) scales and flight heights, together with the corresponding contour intervals, all recommended for the mapping scales generally employed by the NJDOT, are shown in Table 2-1.

**Table 2-1: Photography Scale and Flight Height Guidelines**

MAPPING SCALE	CONTOUR INTERVALS	PHOTO SCALE	FLIGHT HEIGHT
1:300	0.5 M	1:3 000	459 M
1:500	0.5 M	1:4 000	612 M
1:1 000	1.0 M	1:8 400	1 285 M
1:2 000	2.0 M	1:16 800	2 570 M

<sup>1</sup> For nominal focal length of 153 MM

## 2-05 PHOTOGRAMMETRIC GROUND CONTROL

### 2-05.1 Datum's

By definition, the horizontal datum is a rectangular plane coordinate system. Unless approved otherwise by the NJDOT, the Contractor shall reference all horizontal control to the New Jersey State Plane Coordinate System of 1983 (NJSPCS 1983). All horizontal control shall begin and terminate on monuments that are in the National Geodetic Reference Database System (NGRDS)

The vertical datum is normal to gravity. Unless approved otherwise by the NJDOT, the Contractor shall reference all vertical control to the North American Vertical Datum of 1988 (NAVD 88). All vertical control shall begin and terminate on existing benchmarks that are in the National Geodetic Reference Database System (NGRDS).

### 2-05.2 Ground Control Points

Horizontal control points shall be set up as station points in a closed traverse whenever practicable. If field conditions dictate otherwise, control points shall either be tied to the traverse from two different stations or have the angles and distances for single ties measured at least twice. Each control photograph shall be examined carefully in the field to insure that the object described in the photograph is indeed the corresponding object in the field.

Vertical control points shall be set up as turning points on differential level runs. Side shots used for photo control points are not acceptable. Trigonometric leveling is acceptable in lieu of differential leveling if field conditions so dictate and approval is received from NJDOT. However, all distances shall be measured using electronic distance measuring devices in order to insure that the accuracies listed in Table 2-2 can be obtained.

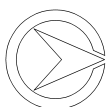

**Table 2-2: Recommended Accuracies**

MAPPING SCALE	HORIZONTAL	VERTICAL
1: 300	60 MM	15 MM
1: 500	90 MM	20 MM
1: 1 000	150 MM	30 MM
1: 2 000	300 MM	90 MM

**Note:** Standard error, defined as the square root of the sum of the squares of the errors from "n" measurements divided by "n", in position and elevation of each control point shall not exceed the recommended accuracies shown.

### 2-05.3 Targeting Control Points

Either control points can be pre-targeted (prior to flight), or photo-identifiable points can be selected for use upon viewing existing aerial photographs. Unless approved otherwise by the NJDOT, the Contractor shall prepare and establish targets in the field for a permanent photographic record to be made by means of aerial photography.

Targets serve to make evident the locations of control points so that the existence and position of each point is easily and accurately discernible when its corresponding image is viewed in an aerial photograph. Targets also pinpoint supplemental control points which enable aerial photographs to be oriented within photogrammetric instruments for use in the stereoscopic compilation of map manuscripts. Additional targets will be provided over existing baseline and right of way monuments or control points. This will permit orienting the maps to plan stationing and plan right of way lines.

Targets shall be placed in the median and shoulder zones of the roadway in question and on flat ground whenever practicable. Steep slopes, sharp ridges and ditches should be avoided. All targets shall be placed on contrasting background so as to be readily distinguishable in aerial photographs.

Each target shall be placed with its center directly over and at the exact elevation of the steel rod or other appropriate manifestation of the control point in question. The target legs should not slope appreciably from the center.

Normally, target spacing shall be at an interval equal to one-fifth (1/5) the flight height. However, for those projects where the required flight height is 365 M or less, targets shall be placed so that at least two (2) will appear in the overlap between adjacent photographs. Accordingly, unless approved otherwise by the NJDOT and as noted above, the guidelines for sizes and center-to-center intervals of white targets shown in Table 2-3 are recommended. The linear dimensions of a black target should be two to three times those tabulated below to allow for image spread in the aerial negatives.

Target shape shall be in the form of either a symmetrical cross, a "T", or a "Y" in that order of preference. The stem of the "T" and each leg of the "Y" shall be equal in length to one half (1/2) the recommended leg length. For Recommended Target Sizes, see Figure 2-1. For Sample Target Plan with Full Field Control, see Figure 2-2.

Targets shall be prepared by painting or printing them on cardboard, muslin or similar cloth, or they shall be constructed of lime placed on the ground, or they shall be painted

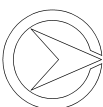

on the roadway surface. In all cases, a cross, "T" or "Y" template shall be used as a guide.

**Table 2-3: Design Guidelines for White Targets**

MAPPING SCALE	FLIGHT HEIGHT	MAXIMUM INTERVAL	TARGET LEG WIDTH	LEG LENGTH
1:300	459 M	110 M	0.15 M	0.6 M
1:500	612 M	192 M	0.15 M	0.9 M
1:1 000	1 285 M	384 M	0.20 M	1.5 M
1:2 000	2 570 M	768 M	0.46 M	3.0 M

#### 2-05.4 Photo-identifiable Control Points

Upon approval by the NJDOT, photo-identifiable control points may be used in lieu of targeting control points. The use of photo-identifiable control points may be authorized if existing aerial photographs are readily available and if the project area is urban or suburban in character where such points would exist in abundance.

Photo-identifiable control points shall be established on permanently fixed objects and shall be of sufficient clarity and definition as to provide the same quality and reliability in aerial photographs as targeted control points. Points that are indefinite or not permanent (e.g. bushes, logs; intersections, roadway centerlines or building corners at a large scale; etc.) are not acceptable.

Photo-identifiable control points shall be maintained at the maximum intervals or less as specified for the placement of new targets with respect to their corresponding flight heights. Such points shall be established in the central zone of the roadway in question and on flat ground whenever practicable. In all other respects, requirements for these points shall correspond to the specifications affecting the layout of targeted control points.

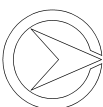



FIGURE 2-1: RECOMMENDED TARGET SIZE

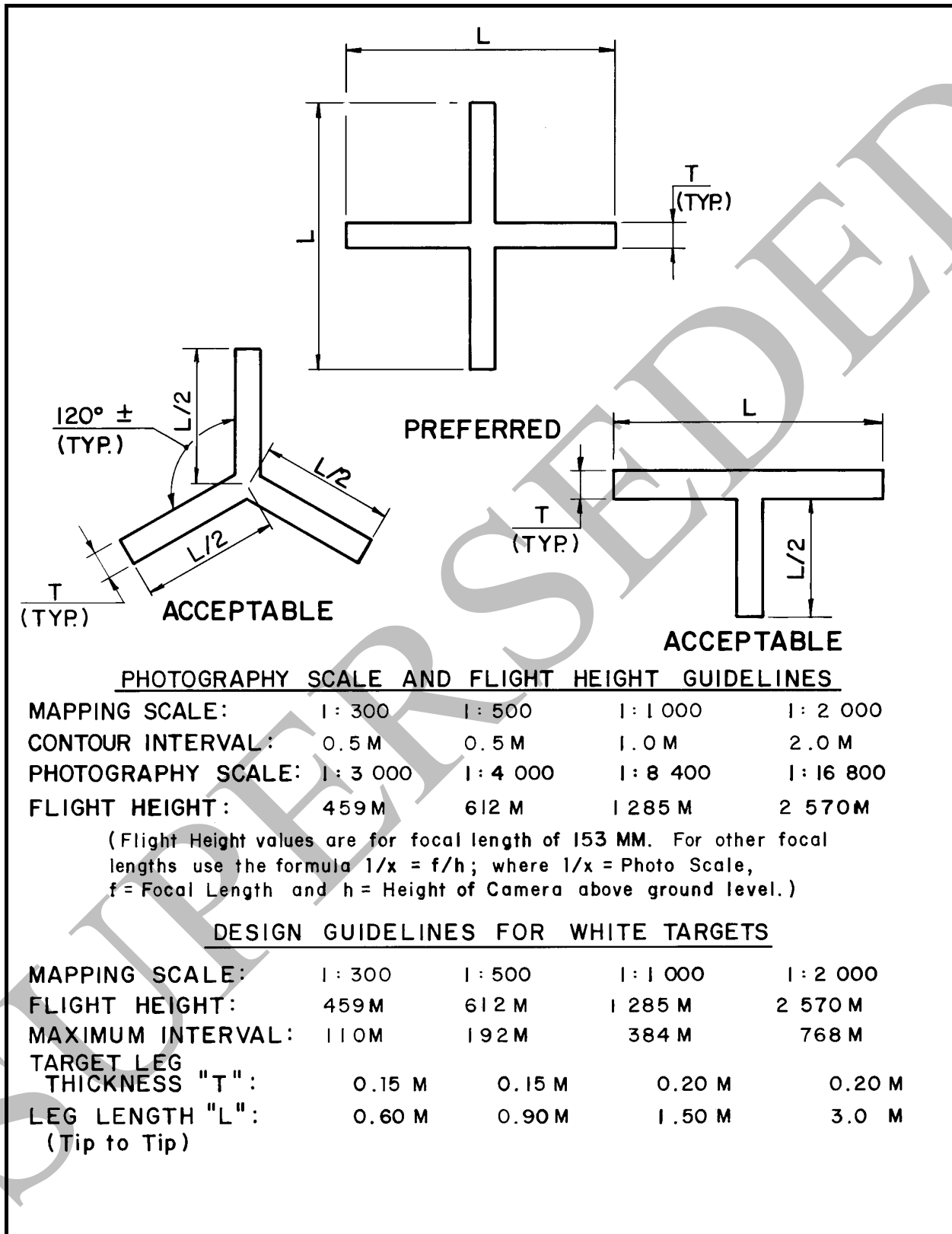
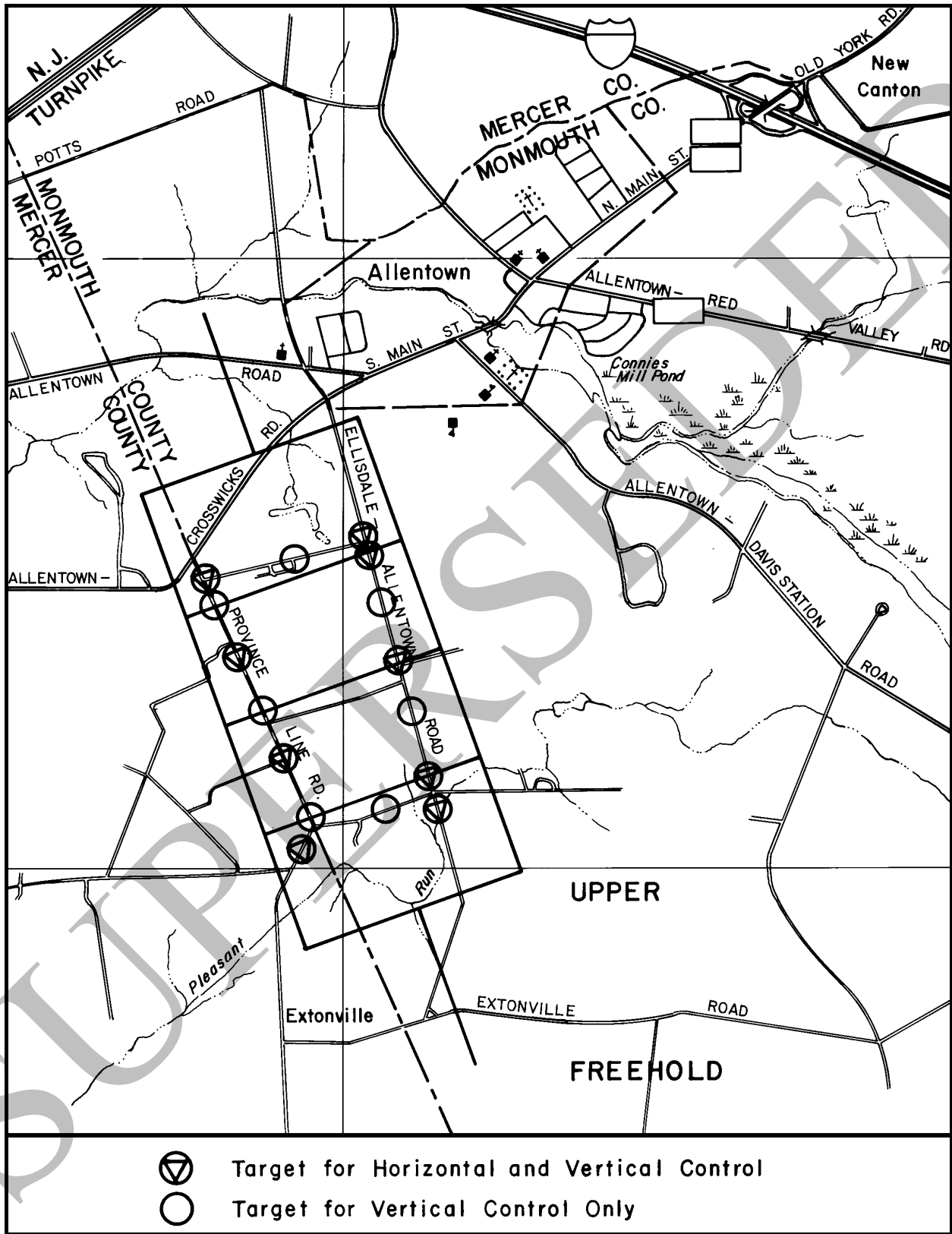

FIGURE 2-2: SAMPLE TARGET PLAN WITH FULL FIELD CONTROL



## SECTION 3

### PHOTOGRAPHIC PRINTS

#### 3-01 DESCRIPTION

##### 3-01.1 Prints

This item shall consist of photographic prints made from aerial photography negatives.

##### 3-01.2 Types of Prints

The photographic prints shall be contacts, reductions, enlargements or such combinations thereof as stipulated by the NJDOT. The prints shall be made of the base materials as directed hereinafter in Section 3-02.1.

#### 3-02 MATERIALS

##### 3-02.1 Base Materials

Base materials of prints shall be of resin-coated photographic paper or of dimensionally stable polyester-type plastic transparent film having a minimum thickness of one tenth of a millimeter (0.10 MM), or as otherwise specified by the NJDOT.

##### 3-02.2 Photographic Emulsion

The photographic emulsion shall be fine grain and have suitable light sensitivity range and contrast for the making of prints on paper or film as specified by the NJDOT. An outdated emulsion shall not be used.

##### 3-02.3 Stability of Film and Paper

Dimensionally stable photographic paper or film shall be used unless approved otherwise by the NJDOT. The difference in shrinkage, expansion, or any linear distortion as measured in any two directions after processing and drying, shall not exceed one part in 400 in photographic paper and one part in 1 000 in photographic film. Such evident distortion shall be cause for rejection.

#### 3-03 REQUIREMENTS

##### 3-03.1 Scale and Size

- a. Contact Prints: Each contact print shall show the scale and size of the negative from which it is printed.
- b. Enlargements: Each enlargement shall be made to the scale or to the diameters of enlargement specified by the NJDOT.

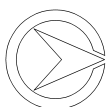

- c. Reductions: Each reduction shall be made to the scale or to the fraction of contact size specified by the NJDOT.

### 3-03.2 Processing Quality

Processing, including exposure, development, fixation, washing and drying of all photographic materials, shall result in finished photographic prints having a fine grain quality and a normal, uniform density. The photographic prints should have such tone and contrast that all of their fine details shall show clearly within their dark and light tone areas as well as in areas with intermediate tones. Adequate grades of contact paper and proper laboratory procedures shall be used to achieve the best prints possible. Excessive variance in tone or contrast between individual prints shall be cause for rejection.

Photographic prints shall be trimmed to neat and uniform dimensional lines along image edges and shall leave distinct the camera fiducial marks. Prints showing fiducial marks of inadequate clarity and definition, or prints omitting fiducial marks, shall be rejected.

All prints shall be clear and free from chemicals, strains, blemishes, uneven spots, air bells, light streaks or fog, and other defects which would, in the opinion of the NJDOT, interfere with their intended purpose. These prints shall be delivered to the NJDOT in a smooth, flat and usable condition.

### 3-03.3 Selection

Upon examination of the contact prints, the NJDOT shall designate the negatives from which additional prints, photographic transparencies, enlargements, reductions, or whatever combination(s) are specified, shall be prepared in accordance with the Contract requirements.

### 3-03.4 Labeling

On the back of each print, whether a contact, reduction or enlargement, and in the same corner and position as the photograph number appears on the image side, there shall be imprinted the following: name and address of the Contractor, the legend PROPERTY, STATE OF NEW JERSEY, DEPARTMENT OF TRANSPORTATION, and the approximate photographic scale, and the focal length in millimeters of the aerial camera.

## 3-04 PHOTOGRAPHIC INDEX

This item shall consist of a sequential layout of aerial photographs designed to form a montage of the entire project area in a single overview. This montage is then photographically reproduced in accordance with the scale and format specified by the NJDOT.

### 3-04.1 Photographic Paper and Film

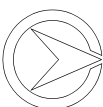

To insure that photographic reproductions possess the attributes described in Section 3-03.2 for processing and quality, contact print paper with adequate contrast and quality shall be used in making prints to prepare the index, and the film and paper for copying and printing the index shall also have adequate contrast and quality and not be outdated.

### **3-04.2 Assembly**

The photographic index shall be assembled by stapling together prints made from acceptable negatives without the negatives being masked. The prints shall be trimmed to a neat and uniform edge along the photographic images without removing the fiducial marks.

The photographs shall be matched by overlapping corresponding images along the flight line. The photographs for each adjacent flight strip shall overlap in the same direction. Air base lengths shall be averaged in the course of matching successive pairs of photographic images along the flight line. Parallel and adjoining flight line assemblies shall be adjusted in length as warranted by incremental movement along the flight line, one photograph with respect to another, until all adjacent flight strip images can be matched as completely as is practicable throughout the entire project area. Upon completion, the assembly shall show clearly the film roll number and the identifying number of each photograph.

### **3-04.3 Labeling and Title Format**

Appropriate notations identifying several important and prominent geographic and cultural features shall appear on the index. The roll number of the film and the exposure number on every tenth (10th) photograph shall be accentuated by the use of a narrow, short-strip overlay of white paper on which the appropriate numbers have been printed. The flight line number shall be noted and accentuated at the end of each strip of photographs.

All overlay lettering and numbering shall be neat and legible on both the index assembly and its photographic copies and shall not interfere with the principal map features or with the symbols, nomenclature and numbers which are not accentuated on the individual photographs. A graphic scale bar shall be shown to denote the average scale of the index.

The legend STATE OF NEW JERSEY, DEPARTMENT OF TRANSPORTATION, the project designation with its corresponding location and project limits, the photography scale, focal length, flight height and date, the Consultants identifying logo with name of firm flying, a north arrow, and the graphic scale bar shall all be arranged in title format according to the layout as prescribed by the NJDOT. Each Photo Index Sheet shall have the approximate grid coordinates of the center of the sheet. The complete title shall be photographically reproduced together with the index or portions thereof. The lettering of the title, as it appears in final form on the index, shall measure not less than two and one half millimeters (2.5 MM) in height and shall be clearly and easily legible.

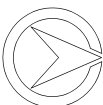

### 3-04.4 Photographic Copying and Printing

The assembly of photographs shall be copied onto photographic film so that prints can be made by the contact or projection method of printing at the Contractor's discretion. If the projection method is selected, the scale of the copy negative shall be not less than one third (1/3) the scale specified for the photographic prints of the index.

Whenever the index cannot be fully copied on one negative, it shall be reproduced sequentially on as many negatives as necessary. Each negative of a segment of the index shall photographically overlay the image on the preceding negative by at least fifty millimeters (50 MM) as measured on the final scale of the index.

### 3-04.5 Size and Scale

All prints of the index shall be made on plastic film as prescribed in Section 3-02.1 and measuring five hundred ninety four millimeter by eight hundred forty-one millimeters (594 MM x 841 MM) between outside edges.

All such prints shall be made to a scale no smaller than one half (1/2) the contact scale of the aerial photography, unless otherwise specified by the NJDOT.

## 3-05 FURNISHING AND DELIVERY

The Contractor shall furnish and deliver two (2) sets of contact prints of all exposures on resin-coated photographic paper to the NJDOT. The Contractor shall similarly furnish and deliver any additional photographic reproductions so designated by the NJDOT.

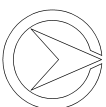

## SECTION 4

### GROUND SURVEYS FOR PRIMARY CONTROL

#### 4-01 GENERAL DESCRIPTION

Ground control consists of a system of points for a given project whose positions are known and referenced to a ground coordinate system, such as the New Jersey State Plane Coordinate System of 1983 (NJSPCS 83) or the North American Datum of 1983 (NAD 83), and whose images can be positively identified in corresponding aerial photographs. Such control is established by means of field surveys and provides the means for precisely orienting and scaling the photographs to the ground.

#### 4-02 MATERIALS AND EQUIPMENT

All materials and equipment required to satisfactorily complete all control surveying work shall be furnished by the Contractor unless stipulated otherwise by the NJDOT. Said equipment shall be fully capable of accomplishing the control surveying to the accuracies specified by the NJDOT.

At the request of the NJDOT, the Contractor will submit documentation showing the latest calibration tests that have been performed, together with the results of these tests, on all survey equipment used or intended for use by the Contractor on the Project. Similarly, all equipment used or intended for use by the Contractor for ground control will be made readily available to the NJDOT for inspection.

#### 4-03 LIAISON

Prior to executing any ground surveys, the Contractor or his authorized representative shall meet with the designated NJDOT representatives, including personnel from the NJDOT Geodetic Survey Unit at the discretion of the NJDOT, for the following purposes:

- To consider the scope of the work and to review the location and suitability of all known existing horizontal and vertical control points in or within the useful proximity of the project area.
- To set forth and concur on the methods and procedures which will satisfy all the ground control requirements of the Project.

#### 4-04 GROUND CONTROL

All ground surveying and related analytical work required to execute primary or basic control surveys shall be accomplished by the Contractor in accordance with the procedures and accuracies as specified by the NJDOT. All control points shall be set from and closed on existing National Geodetic Survey (NGS) monuments; NJDOT Geodetic Survey (NJGS) triangulation; or GPS, traverse stations which meet second or higher order accuracy surveys and are part of the National Geodetic Survey Data Base.

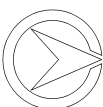

If the Contractor has utilized any control monuments other than existing NGS or NJGS controls, the Contractor shall certify that the ground control meets the accuracies and standards specified by the NJDOT. The Contractor shall also provide the NJDOT with certification, signed and sealed by a qualified Land Surveyor (see Section 1-05), that the accuracies and standards specified by the NJDOT have been met.

All primary and other basic control surveys must begin and close on at least two separate existing control points or, if approved by the NJDOT, such surveys shall be closed-circuit in character.

Those control points which are used as origin, intermediate check, and closure points shall be points comprising closed primary traverses and closed level circuits. Primary or other basic control surveys shall measure accurately each required control point, and accuracy checks shall be made on the surveying work as a whole.

Control points consisting of monuments or station markers and bench marks which are set by the Contractor shall be numbered consecutively from the beginning of the Project to the end for each traverse and level run. Each traverse shall be identified with a letter designation starting with the first letter of the alphabet, and each level run shall receive a letter designation starting with the last letter of the alphabet and working backwards.

Semi-permanent monuments, station markers, and other control points shall be set along the traverse routes at the minimum rate of two (2) intervisible pair per kilometer of traverse length. A minimum of four (4) bench marks per kilometer of traverse length shall be set. These control points shall not be placed in roadway or shoulder pavement unless such placement has been approved by the NJDOT. Control points can also be set by chiseling crosses in concrete structures or rock outcrops.

All monuments or station markers, bench marks and any other control points placed by the Contractor shall be tied and referenced in the field.

#### 4-04.1 Permanent Monuments or Survey Station Markers

- a. **Materials:** Permanent monuments or survey station markers in first and second order surveys shall be bronze or brass plugs or aluminum alloy tablets set in iron pipes, in copper-coated steel rods, in concrete monument foundations, or cemented in large solid rocks or boulders. The Contractor shall furnish all plugs or tablets, and other necessary parts of a design as illustrated in Figures 4-1, 4-2, 4-3 and 4-4.

In third-order surveys, semi-permanent monuments and station markers shall be pins of nineteen millimeters (19 MM) or more in diameter and not less than nine tenths of a meter (0.9 M) long, or they shall be as specified in the preceding paragraph.

Within the public domain or subject to a clear, legally binding agreement with the affected property owner(s), set reference marks shall consist of nails or

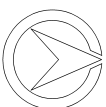



spikes driven into large trees which are nonornamental and do not bear fruit; of lead plugs drilled in walls, abutments, solid rock outcrops and like objects which are permanent in character; or they may consist of steel T-bars.

- b. Control: All permanent monuments and station markers and their references shall be set where they will not be disturbed by normal land use. Wherever practicable, such markers shall be placed near some easily recognizable feature and in an accessible location. Such placement shall be preferably established outside future construction sites but within the right-of-way boundaries of the proposed project. At least three (3) references shall be accurately placed so that the markers may be recovered or reset readily on any subsequent field surveys. Ties to the references must be accurately measured with a steel tape or EDM so that it will be possible to make an accurate intersection of three predetermined measurements to facilitate recovering each control point. Such references shall be of the semi-permanent type and shall be so located as to be visible from and accessible to the station marker to which it applies.

Semi-permanent reference marks may consist of spikes driven into trees, well-established fence lines, and durable marks set in rock outcrops, footings, building walls and the like. Where such suitable features are not available, a steel T-bar, which is no less than nine tenths of a meter (0.9 M) long with a special distinctive cap in which the reference cross has been imprinted, shall be set to serve in its place.

In the field notes, the Contractor shall clearly sketch to scale and otherwise describe the surveyed position of each permanent station marker together with its reference data. The Contractor shall also record any azimuth marks for those markers which are not intervisible for subsequent plotting on the maps. The bearing on the New Jersey State Plane Coordinate grid shall be noted between each station marker and its adjacent visible markers. The New Jersey State Plane Coordinates for each permanent station marker shall also be recorded.

Each existing and new project permanent survey station marker shall be appropriately identified in its correct New Jersey State Plane Coordinate position on the maps and shall be numbered, named and/or stationed in the format stipulated by the NJDOT. The following data shall accompany the record of each marker on the maps: the number designation, the New Jersey State Plane Coordinates and, if a previously existing marker, the contract designation under which it was either set or last reset and surveyed. Except for the horizontal position and classification number, all identification data for each marker shall be recorded on the maps as marginal inserts.

Each marker position shall be indicated by a symbol in the overlap portion within each aerial photograph of the applicable stereoscopic pair. Said symbol shall consist of a photographic image showing a circle rendered thereon in the correct New Jersey State Plane Coordinate position.

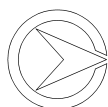

A description card shall be prepared containing the following information:

- (1) Name, number or station.
- (2) Municipality and County
- (3) Mile marker and station if on a State Highway
- (4) Order of accuracy.
- (5) New Jersey State Plane Coordinate System (NJSPCS 83).
- (6) North American Vertical Datum of 1988 (NAVD 88) elevation in meters.
- (7) Name of Contractor or agency making the control survey.
- (8) Date the monument or station marker was set.
- (9) Complete description of location and type of marker. This description should include information on how to reach the general location of the Station Site from a town or from some prominent feature normally displayed on maps, and distance from a major roadway intersection.
- (10) Sketch showing distance, true bearing and New Jersey State Plane Coordinate grid bearing to each adjacent station marker, control point and reference point.

These descriptions shall become a part of the Survey Control Report as described in Section 4-08.2.

#### 4-04.2 Survey Bench Marks

- a. **Materials:** Survey bench marks shall be bronze or brass plugs or aluminum alloy tablets either set in iron pipes, copper-coated steel rods, or concrete monument foundations, or cemented in large solid rocks or boulders as illustrated in Figures 4-1, 4-2, 4-3 and 4-4. Iron or other pins less than nineteen millimeters (19 MM) in diameter and less than nine tenths of a meter (0.9 M) long shall not be used. All plugs or tablets shall be furnished by the Contractor. The heads of the plugs or tablets shall be approximately seventy-six millimeters (76 MM) in diameter.

When permanent or semi-permanent objects cannot be found to serve as reference for bench mark ties, references shall then consist of lead or copper nails plugging holes drilled in either concrete, large boulders or rock outcrops, or nineteen millimeters (19 MM) or larger diameter metal pins at least nine tenths of a meter (0.9 M) long as field circumstances dictate.

- b. **Control:** All bench marks shall be set where they will not be disturbed by normal land use. Wherever practicable, such bench marks shall be placed near some easily recognizable feature and in an accessible location.

Within the public domain or subject to a clear, legally binding agreement with the affected property owner (s), at least two (2) references shall be accurately placed so that the bench marks may be recovered readily on any subsequent field survey. Such references shall be of the semi-permanent type and shall be so located as to be visible from and accessible to the bench mark to which it applies. Semi-permanent reference marks may consist of spikes driven into

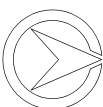

trees which are non-ornamental and do not bear fruit, well established fence lines, and durable marks set in rock outcrops, footings, building walls and the like. Where such suitable features are not available, a steel T-bar, which is no less than nine tenths of a meter (0.9 M) long with a distinctive cap in which the reference cross has been imprinted, shall be set to serve in its place.

Subject to inspection and approval by the NJDOT Geodetic Survey Unit, all elevations shall be referenced to the North American Vertical Datum of 1988 (NAVD 88) unless specified otherwise by the NJDOT.

Existing bench marks serving as origin or closing ties in the ground control surveys may be appropriated as project bench marks whenever they are in position to serve as such. In the field notes, the Contractor shall sketch to a reasonable scale the position of each existing bench mark used, and he shall record the identifying number and description of that bench mark. The Contractor shall not mark, stamp or otherwise deface or disturb any existing bench mark.

Each bench mark utilized for the project within the mapped area shall be identified on the maps by a symbol in the correct New Jersey State Plane Coordinate position. Near that symbol, the identifying number and New Jersey Geodetic Survey-based elevation of that bench mark shall be correctly and clearly recorded. In addition, the position of each bench mark shall be represented by the same symbol in the overlap portion within each aerial photograph of the applicable stereoscopic pair of such photographs. Said symbol shall consist of a photographic image showing a circle rendered in the correct New Jersey State Plane Coordinate position on the photograph.

#### 4-04.3 Semi-permanent Survey Station Markers

- a. Materials: Semi-permanent station markers shall consist of either: a cross in a lead or copper nail plugging a hole drilled in concrete, a rock outcrop or a large boulder; a cross in the top of a 19 MM x 460 MM T-bar of galvanized steel that has been driven flush with the ground or to a depth of 250 MM below the surface of the ground when in an open field; or a metal pipe 13 MM to 25 MM in diameter, 610 MM to 760 MM long, or a solid metal pin, twenty millimeters (20 MM) or more in diameter, of similar length.
- b. Control: Semi-permanent station markers shall be set at as many instrument setup points in the required surveys as practicable. Where feasible, they shall also be set at points targeted on the ground before photography for certainty in identification of supplemental control points to be used in photographic control during the photogrammetric compilation process.

In the field notes, the Contractor shall sketch to scale and shall fully identify and otherwise describe all semi-permanent station markers. These markers shall be survey-tied from primary or basic control survey points to objects that are visible

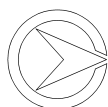

on aerial photographs, or they shall have a suitable photographic target centered over them on the ground before aerial photographs are taken.

Each semi-permanent station marker within the mapped area shall be appropriately identified on the maps and shall be stationed or numbered in the format stipulated by the NJDOT. Such identification shall be made with respect to the New Jersey State Plane Coordinate System.

#### 4-04.4 Primary Horizontal Control

The Contractor shall establish at least one primary closed traverse and/or triangulation or trilateration network or GPS network as needed throughout and generally parallel to the longer dimension of the Project. Unless specified otherwise by the NJDOT, the traverse closure shall not exceed the lesser of either one part in twenty thousand (1:20 000) of the total traverse length, or 0.20 meters times the square root of the total traverse length in kilometers after azimuth adjustments, the result being in terms of meters. Classification, standards of accuracy and general specifications for horizontal controls for traverse, triangulation and trilateration are tabulated in Tables 4-1 and 4-2. All adjustments shall be based on Least Squares Adjustment.

Each and every horizontal control station shall be an integral part of its respective traverse, and all such stations shall be so set upon with angular and distance measuring equipment that each angle and distance is observed directly from station to station and not computed from an alternate point. Each control station is set in the field with a semi-permanent station marker consisting of a cross marked on a nail plugging a hole drilled in a concrete structure or rock outcrop, footing, building wall and the like.

All station markers shall either be intervisible or require that an azimuth mark be established for each non-intervisible station marker. The azimuth mark shall be placed anywhere between one hundred to three hundred meters (100 M - 300 M) away from the station marker to insure that the bearing determined by an instrument set over the marker and sighted on the azimuth mark is accurate to within fifteen seconds ( $\pm 15''$ ) of arc.

Cultural features which are permanent, suitable and easily identifiable shall be acceptable as azimuth marks. If such objects are not available, azimuth marks shall be identified as such from spikes driven into large trees which are non-ornamental and do not bear fruit, metal plugs in drilled holes, and crosses chiseled in concrete structures and rock outcrops, as field circumstances dictate.

All primary horizontal control points and stations shall be field-referenced with at least three (3) well placed ties.

All angles shall be turned with a one-second ( $1''$ ) direct reading theodolite, and approved methods shall be employed to guarantee the following results:

- The angular difference between the highest and lowest angle formed by the points shall not be greater than six seconds ( $6''$ ). The angular adjustment at

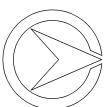

azimuth check points shall not exceed the lesser of six seconds (6'') times the number of stations used for carrying azimuth or two seconds (2'') per station.

- All horizontal control positions shall be adjusted to the North American Datum of 1983, and New Jersey State Plane Coordinates of 1983 shall be computed for each horizontal control point. All azimuths shall be ascertained and recorded with respect to the New Jersey State Plane Coordinate System grid lines unless an alternate reference system is approved by the NJDOT.

**Table 4-1: Classification, Standards of Accuracy, and General Specifications for Horizontal Control**

CLASSIFICATION	FIRST-ORDER	SECOND-ORDER		THIRD-ORDER	
		CLASS I	CLASS II	CLASS I	CLASS II
<b>TRAVERSE :</b>					
<i>Recommended spacing of principal stations</i>					
	Network stations 10-15 KM; other surveys seldom less than 3 KM	Principal stations seldom less than 4 KM except in metropolitan area surveys where the limitation is 0.3 KM	Principal stations seldom less than 2 KM except in metropolitan area surveys where the limitation is 0.2 KM	Seldom less than 0.1 KM in tertiary surveys in metropolitan area surveys; required for other surveys	
<i>Horizontal directions or angles<sup>2</sup></i>					
Instrument	0."2	0."2 } or { 1."0	0."2 } or { 1."0	1."0	1."0
Number of Observations	16	8 } or { 12	6 } or { 8	4	2
Rejection limit from mean	4"	4" } or { 5"	4" } or { 5"	5"	5"
<i>Length measurements</i>					
Standard error <sup>1</sup>	1 part in 600 000	1 part in 300 000	1 part in 120 000	1 part in 60 000	1 part in 30 000
<i>Reciprocal vertical angle observations<sup>3</sup></i>					
Number of and spread between observations	3 D/R-10"	3 D/R-10"	2 D/R-10"	2 D/R-10"	2 D/R-20"
Number of stations between known elevations	4-6	6-8	8-10	10-15	15-20

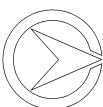

**TABLE 4-1: Classification, Standards of Accuracy, and General Specifications for Horizontal Control (cont.)**

CLASSIFICATION	FIRST-ORDER	SECOND-ORDER		THIRD-ORDER	
		CLASS I	CLASS II	CLASS I	CLASS II
<b>TRAVERSE :</b>					
<b>Astro azimuths</b>					
Number of courses between azimuth checks <sup>5</sup>	5-6	10-12	15-20	20-25	30-40
Number of observations per night	16	16	12	8	4
Number of nights	2	2	1	1	1
Standard error	0."45	0."45	1."5	3."0	8."0
Azimuth closure at azimuth checkpoint not to exceed <sup>6</sup>	1."0 per station or 2" $\sqrt{N}$	1."5 per station or 3" $\sqrt{N}$ Metropolitan area surveys seldom to exceed 2."0 per station or 3" $\sqrt{N}$	2."0 per station or 6" $\sqrt{N}$ Metropolitan area surveys seldom to exceed 4."0 per station or 8" $\sqrt{N}$	3."0 per station or 10" $\sqrt{N}$ Metropolitan area surveys seldom to exceed 6."0 per station or 15" $\sqrt{N}$	8" per station or 30" $\sqrt{N}$
<b>Position closure<sup>4,6</sup></b>					
after azimuth adjustment	0.04 M $\sqrt{K}$ or 1:100 000	0.08 M $\sqrt{K}$ 1:50 000	0.2 M $\sqrt{K}$ 1:20 000	0.4 M $\sqrt{K}$ 1:10 000	0.8 M $\sqrt{K}$ 1:5 000
<p>1. The standard error is to be estimated by</p> $\sigma_M = \left( \frac{\sum v^2}{n(n-1)} \right)^{1/2}$ <p>where <math>\sigma_M</math> is the standard error of the mean, <math>v</math> is a residual (that is, the difference between a measured length and the mean of all measured lengths of a line), and <math>n</math> is the number of measurements.</p> <p>The term "standard error" used here is computed under the assumption that all errors are strictly random in nature. The true or actual error is a quantity that cannot be obtained exactly. It is the difference between the true value and the measured value. By correcting each measurement for every known source of systematic error, however, one may approach the true error. It is mandatory for any practitioner using these table to reduce to a minimum the effect of all systematic and constant errors so that real accuracy may be obtained. (See page 267 of Coast and Geodetic Survey Special Publication No. 247, <i>Manual of Geodetic Triangulation</i>, Revised edition, 1959, for definition of "actual error".)</p> <p>2. The figure for "Instrument" describes the theodolite recommended in terms of the smallest reading of the horizontal circle. A position is one measure, with the telescope both direct and reversed, of the horizontal direction from the initial station to each of the other stations. See FGCC "Detailed Specifications" for number of observations and rejection limits when using transits.</p> <p>3. See FGCC "Detailed Specifications" on "Elevation of Horizontal Control Points" for further details. These elevations are intended to suffice for computations, adjustments, and broad mapping and control projects, not necessarily for vertical network elevations.</p> <p>4. Unless the survey is in the form of a loop closing on itself, the position closures would depend largely on the constraints or established control in the adjustment. The extent of constraints and the actual relationship of the surveys can be obtained through either a review of the computations, or a minimally constrained value adjustment of all work involved. The proportional accuracy or closure (i.e., 1/100 000) can be obtained by computing the difference between the computed value and the fixed value, and dividing this quantity by the length of the loop connection the two points.</p> <p>5. The number of azimuth courses for first-order traverses are between Laplace azimuths. For other survey accuracies, the number of courses may be between Laplace azimuths and/or adjusted azimuths.</p> <p>6. The expressions for closing errors in traverses are given in two forms. The expression containing the square root is designed for longer lines where higher proportional accuracy is required. The formula that gives the smallest permissible closure should be used. <math>N</math> is the number of stations for carrying azimuth. <math>K</math> is the distance in kilometers.</p>					

(Federal Geodetic Control Committee. (1975) 1980. Classification, standards of accuracy, and general specifications of geodetic control surveys. Reprint.)

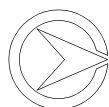
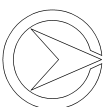

Table 4-2: Classification of Triangulations

CLASSIFICATION	FIRST ORDER	SECOND ORDER		THIRD ORDER	
		CLASS I	CLASS II	CLASS I	CLASS II
<b>TRIANGULATION :</b>					
<b>Recommended spacing of principal stations</b>					
	Network stations seldom less than 15 KM; metropolitan surveys 3 to 8 KM and others as required	Principal stations seldom less than 10 KM; other surveys 1 to 3 KM or as required	Principal stations seldom less than 5 KM or as required	As required	As required
<b>Strength of figure <math>R_1</math> between bases</b>					
Desirable limit	20	60	80	100	125
Maximum limit	25	80	120	130	175
Single figure desirable limit					
$R_1$	5	10	15	25	25
$R_2$	10	30	70	80	120
Single figure maximum limit					
$R_1$	10	25	25	40	50
$R_2$	15	60	100	120	170
<b>Base measurement</b>					
Standard error <sup>a</sup>	1 part in 1 000 000	1 part in 900 000	1 part in 800 000	1 part in 500 000	1 part in 250 000
<b>Horizontal directions</b>					
Instrument	0."2	0."2	0."2 } or { 1."0	1."0	1."0
Number of positions	16	16	8 } or { 12	4	2
Rejection limit from mean	4"	4"	5" } or { 5"	5"	5"
<b>Triangle closure</b>					
Average not to exceed	1."0	1."2	2."0	3."0	5."0
Maximum seldom to exceed	3."0	3."0	5."0	5."0	10."0
<b>Side checks</b>					
In side equation test, average correction to direction not to exceed	0."3	0."4	0."6	0."8	2"
<b>Astro azimuths</b>					
Spacing figures	6-8	6-10	8-10	10-12	12-15
Number of observations per night	16	16	16	8	4
Number of nights	2	2	1	1	1
Standard error	0."45	0."45	0."6	0."8	3."0
<b>Vertical angle observations</b>					
Number of and spread between observations	3 D/R-10"	3 D/R-10"	2 D/R-10"	2 D/R-10"	2 D/R-20"
Number of figures between known elevations	4-6	6-8	8-10	10-15	15-20
<b>Closure in length (also position when applicable)</b>					
after angle and side conditions have been satisfied should not exceed	1 part in 100 000	1 part in 50 000	1 part in 20 000	1 part in 10 000	1 part in 5 000

(Courtesy National Ocean Survey. Reprint)



#### 4-04.5 Primary Vertical Control

The Contractor shall establish at least one primary closed level circuit as needed throughout and generally parallel to the longer dimension of the Project. Each level circuit shall be established by following the accepted procedures of differential leveling. No trigonometric leveling shall be permitted, and no "spur" or "hanging" vertical points shall be accepted.

All primary or basic vertical control shall be extended from and closed on National Geodetic Survey Bench Marks of second or higher order accuracy and shall be of second order accuracy. All vertical control positions shall be referenced to the North American Vertical Datum of 1988 (NAVD 88). The Contractor shall adjust all vertical elevations to the North American Vertical Datum of 1988 (NAVD 88), unless approved otherwise by the NJDOT. All vertical control circuits required for the Project other than the primary circuit (s) shall begin and close on the level network of primary elevation control set and surveyed by the National Oceanic and Atmospheric Administration (NOAA) unless approved otherwise by the NJDOT.

Semi-permanent bench marks shall be set at the approximate rate of two for each kilometer of bench level route and shall not be set further apart vertically than ten meters (10 M) difference in elevation. Such bench marks shall be of second order accuracy unless specified otherwise by the NJDOT.

Second order Class II vertical accuracy shall be defined as having a minimum error vertical closure of 8 millimeters (8 MM) times the square root of the length of the level circuit in kilometers  $[8 \text{ MM} (K)^{1/2}]$  (see Table 4-3). All bench level lines shall be properly adjusted to minimize if not eliminate any error contained therein.

At least two (2) well placed ties shall be required to field-reference each vertical control point established by the Contractor.

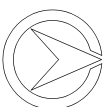



**Table 4-3: Classification, Standards of Accuracy, and General Specifications for Vertical Control**

CLASSIFICATION	FIRST-ORDER		SECOND-ORDER		THIRD-ORDER
	CLASS I, CLASS II	CLASS I	CLASS II	CLASS II	
<b>Principal uses</b> Minimum standards; higher accuracies may be used for special purposes	Basic framework of the National Network and of metropolitan area control	Secondary control of the National Network and of metropolitan area control	Control densification, usually adjusted to the National Net. Local engineering projects	Miscellaneous local control may not be adjusted to the National Network.	
	Extensive engineering projects	Large engineering projects	Topographic mapping	Small engineering projects	
	Regional crustal movement investigations	Local crustal movement and subsidence investigations	Studies of rapid subsidence	Small-scale topographic mapping	
	Determining geopotential values	Support for lower-order control	Support for local surveys	Drainage studies and gradient establishment in mountainous areas	
<b>Recommended spacing of lines</b>	Net A; 100-300 KM <i>class I</i>	Secondary net; 20-50 KM	Area control; 10-25 KM	As needed	
	National Network	Net B; 50-100 KM <i>class II</i>			
Metropolitan control; other purposes	2-8 KM	0.5-1 KM	As needed	As needed	
	As needed	As needed	As needed	As needed	
<b>Spacing of marks along lines</b>	1-3 KM	1-3 KM	Not more than 3 KM	Not more than 3 KM	
<b>Gravity requirement</b>	0.20 x 10 <sup>-3</sup> gpu				
<b>Instrument standards</b>	Automatic or tilting levels with parallel-plate micrometers; invar scale rods	Automatic or tilting levels with optical micrometers or three-wire levels; invar scale rods	Geodetic levels and invar scale rods	Geodetic levels and rods	
<b>Field procedures</b>	Double-run; forward and backward, each section	Double-run; forward and backward, each section	Double- or single-run	Double- or single-run	
Section length	1-2 KM	1-2 KM	1-3 KM for double-run	1-3 KM for double-run	
Maximum length of sight	50 M <i>class I</i> ; 60 M <i>class II</i>	60 M	70 M	90 M	
<b>Field procedures<sup>a</sup></b>					
Max. difference in lengths					
Forward and backward sights per setup	2 M <i>class I</i> ; 5 M <i>class II</i>	5 M	10 M	10 M	
per section (cumulative)	4 M <i>class I</i> , 10 m <i>class II</i>	10 M	10 M	10 M	
Maximum length of line between connections	Net A; 300 KM		50 KM double-run	25 KM double-run	
	Net B; 100 KM	50 KM	25 KM single-run	10 KM single-run	
<b>Maximum closures<sup>b</sup></b>					
Section; forward and backward	3 MM $\sqrt{K}$ <i>class I</i> , 4 MM $\sqrt{K}$ <i>class II</i>	6 MM $\sqrt{K}$	8 MM $\sqrt{K}$	12 MM $\sqrt{K}$	
Loop or line	4 MM $\sqrt{K}$ <i>class I</i> , 5 MM $\sqrt{K}$ <i>class II</i>	6 MM $\sqrt{K}$	8 MM $\sqrt{K}$	12 MM $\sqrt{K}$	

<sup>a</sup>The maximum length of line between connections may be increased to 100 KM for double-run for second-order class II, and to 50 KM for double-run for third-order in those areas where the first-order control has not been fully established.

<sup>b</sup>Check between forward and backward runnings, where  $K$  is the distance in kilometers.

(Federal Geodetic Control Committee. (1975) 1980. Classification, standards of accuracy, and general specifications of geodetic control surveys. Reprint.)

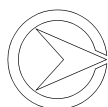

#### 4-05 SURVEY TRAVERSE FOR CADASTRAL SURVEYS

This section shall apply when cadastral (property boundary) surveys are required in conjunction with the compilation of large-scale maps. Cadastral surveys are to be tied in with conventional surveying and GPS surveying methods to the primary control points as represented by station markers. These markers comprise the primary control traverse to be surveyed and otherwise shall be intervisible and spaced as specified by the NJDOT.

In areas where the width of the survey area is increased, additional traverses shall be surveyed as needed. Wherever multiple flight strips are essential for accomplishing the required mapping, a traverse shall be surveyed lengthwise along the approximate center of each strip. All such traverses shall be executed as closed traverses within the primary horizontal control of the Project.

All resulting survey data shall be noted and drawn on the map(s) and shall include each instrument point, each survey origin/closure set of ties to primary control, and the distances and New Jersey State Plane Coordinate bearings of each traverse segment. Closure ties shall either be shown at their location on the map(s) or they shall be marginal inserts wherever their corresponding principal control points lie outside the mapped area. Each control point and each instrument point shall be plotted accurately and designated by its New Jersey State Plane Coordinates.

#### 4-06 LOCATING MONUMENTS ON MAPS

The location of each monument, which is set and otherwise utilized by the Contractor, shall be indicated on the maps in conjunction with its corresponding identifying data: number designation, its New Jersey State Plane Coordinates, the elevation, if any, and information tying the monument to a primary survey line or other appropriate field-established reference(s) to facilitate future recovery. Except for showing the positions of those monuments actually situated within the areas covered by the maps, all annotations shall be recorded in marginal inserts.

Whenever existing control monuments are taken from previous mapping contracts, whether prepared for the NJDOT or another agency or client, the original contract project designation and its corresponding "as built" date shall be noted on the maps.

#### 4-07 SUPPLEMENTAL CONTROL SURVEYS

Whenever supplemental control is to be established from ground surveys, the Contractor shall execute those surveys so that corresponding aerial photographs can be correctly positioned and oriented onto precision photogrammetric mensuration instruments. These instruments shall be capable of providing measurements to a precision of one (1) micron, and they shall be calibrated over the measuring range of the Project to an accuracy sufficient to achieve a root mean square error of no more than two (2) microns. The Contractor shall utilize only fully analytical aerial triangulation methods to establish supplemental photo control. Semi-analytic or analog methods shall not be permitted.

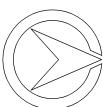

#### 4-07.1 Horizontal Control

A minimum of three (3) horizontal control points is required for each stereoscopic model although a fourth point is recommended as a check, and these points shall be as far apart as is feasible within each model. Each model point shall be an image of an existing object in the field, or it shall be part of a finite photographic pattern which is readily identifiable on the ground in the photographs, or it shall be the photographic target of a station marker. The X and Y coordinates of horizontal control shall be subsequently computed for each supplemental control point with respect to the New Jersey State Plane Coordinate System.

#### 4-07.2 Vertical Control

In each stereoscopic model, there shall be at least six (6) vertical control points, one of which shall be near the center of the model and approximately halfway between the principal point of the first aerial photograph and its corresponding image on the adjacent photograph. The other points shall be spaced for optimum use of the model and preferably so as to include one in or near each corner of the model. Wherever cross sections are to be measured photogrammetrically, there shall be at least three (3) additional vertical control points spaced appropriately throughout the measuring and mapping area of each model. The elevation (or Z coordinate) of vertical control, as referenced to the North American Vertical Datum of 1988, shall be ascertained for each supplemental point.

#### 4-07.3 Supplemental Photo Control - Analytical Aerotriangulation

If so elected by the Contractor and upon approval by the NJDOT, analytical aerotriangulation methods may be employed to generate supplemental control points and to compute the required corresponding coordinate data.

In order to carry out analytics, all ground control points must be pre-targeted in accordance with Figure 2-1, with the exception of maximum interval. When controlling projects designed for analytical aerotriangulation, the maximum interval for horizontal control points shall be no more than five (5) stereomodels, and for vertical control points, no more than two (2) stereomodels.

The beginning and end of all flight lines must be controlled by three (3) horizontal and vertical control points.

The analytical computations must result in a minimum root mean square error at the control points of one part in ten thousand (1:10 000) of the flight height.

A minimum of nine (9) precisely mark supplemental control points will be established for each photograph and six (6) points will be located as near as possible to the corners and the nadir point of the neat model.

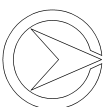

The process is initiated with the precise marking of glass photographic diapositives to be used for mapping compilation at those locations where supplemental control is required. All point-marking shall be done using a precision stereoscopic marking device. Such marks shall not be smaller than forty (40) microns no larger than one hundred (100) microns, and they shall be appropriate in size to the scale of the photographs and the stereoscopic plotting instruments. All marks shall be drilled clearly through the emulsion of the diapositives, and excess waste material shall be removed carefully from the surface prior to the mensuration operation.

Each diapositive shall be placed in a mono- or stereo- comparator, having a precision of one ( $\pm 1$ ) micron, which shall then be used to measure the locations of the supplemental control points and the field-surveyed control points relative to the photo-coordinate system formed from the fiducial marks on that diapositive. The comparator shall be calibrated over the measuring range to be used on this Project to an accuracy sufficient to achieve a root mean square error of two (2) microns.

The measurements of both sets of control points, the X, Y and Z grid coordinates of the field surveyed control points, and the camera calibration data, shall be entered together into a computer which will then generate the ground coordinates for the supplemental control points. The computer software utilized shall contain a fully analytical block aerotriangulation program. This program and the density of the control network shall work in conjunction with each other so that the accuracies required by the NJDOT are met. As a minimum, this program shall incorporate the capability to give appropriate weight factors to the control points on an individual basis and to correct for film deformation, atmospheric refraction, earth curvature and lens distortion.

## **4-08 DOCUMENTATION**

### **4-08.1 Field Notes**

The field notes of all horizontal and vertical control surveys shall be fully indexed and kept in securely bound notebooks. The notes shall be uniform in character and recorded in such a manner as to be easily and correctly interpretable by anyone having a knowledge of surveying. There shall be no erasures; rejected readings shall have a line drawn through them with the replacement or corrected data written beside or above the original entry. In addition, each page of field notes shall contain the Project designation, the names of the survey crew personnel, the date of the survey, a brief description of weather conditions, and a record of the field book number and page number.

The field notes shall contain a description and identifying number of the equipment employed, the rod type, a reading of the atmospheric pressure as needed, prism constants, and all other parameters and attributes having a significant effect on the results of survey work.

The field notes shall contain descriptions and sketches of the existing primary control used for origin and closure as well as for data on the primary and supplemental control of the entire Project. The results of the primary control survey(s) executed by the

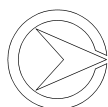

Contractor shall be accurately tabulated and adjusted to conform to the requirements specified by the NJDOT under Section 4-04.1 and Section 4-04.2. These notes shall

Upon completion of the work, the Contractor shall forward all field notes and all computation and adjustment sheets to the NJDOT, and shall become the property of

#### 4-08.2 Control Report

control report containing all the pertinent data on primary control for the Project. The control report shall be prepared on 210 MM x 297 MM sheets and shall consist of a and sketches of all control points and their field ties together with references to the control network for the entire Project, and a control diagram index drawn approximately

The original computations and adjustments and the original descriptions and sketches shall be prepared on 210 MM x 297 MM sheets and furnished to the NJDOT in a be in a computer format that is compatible with NJDOT software.

- a. \_\_\_\_\_: The narrative section shall clearly and concisely report on the existing primary control utilized for the origin and closure of each primary shall also be provided covering the methods used to produce the Project primary control survey in conjunction with the closure ties, the actual closures adjustments. Relevant details shall be correlated with the control diagram and the information contained therein where appropriate.
- b. Control Diagram the control report. It shall be prepared to a scale no smaller than one to twenty four thousand (1:24 000) and shall show clearly the arrangement of existing

The control diagram may be rendered on an existing topographic or other key map as a base plan for plotting each control point, or it may be prepared

- (1) Where applicable, the actual boundaries of the separate map sheets to the map sheet numbers assigned to them for the Project.
- (2) Project area and recovered for use as origin and closure points.

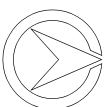

- (3) All azimuth marks and their locations, as well as all station markers and bench marks used to establish any and all traverses, triangulation and trilateration nets, and all bench marks and level circuits
  - (4) An appropriate title and legend for the Project designation, a north arrow showing the direction of orientation of the control diagram, the symbols used, and a graphic scale applicable to the control diagram.
- c. **Computations:** The coordinates of each point shall be reported in the system and datum for the project, either New Jersey State Plane Coordinate system, or North American 1988 Datum. Reduction, correction, closure and adjustment computations of each traverse surveyed shall include:
- Verification that azimuth closure specifications are met in accordance with classifications and accepted standards of accuracy contained in Table 4-1.
  - Correction of angles for systematic error. The azimuth closure errors may be distributed evenly or by weighted least squares computation.
  - Verification that position closure specifications are met (using corrected angles), in accordance with accepted classifications and standards of accuracy in Table 4-1. Specifications must be met computing both from start to end and from end to start.
  - Field distances (EDM measurements) shall be converted to Grid distances by multiplying by the combined scale factor and sea level (Elevation) factor. Plane traverses may be adjusted by any of the standard adjustment methods.
  - The control report shall include a tabulation of the Plane Coordinates of each survey station before traverse adjustments and after traverse adjustments.

## 4-09 GLOBAL POSITIONING SURVEYING SYSTEM

### 4-09.1 General

One of the modern methods of establishing Geodetic Control for Photogrammetric mapping is the Global Positioning System (GPS). GPS Satellite Surveying is a three-dimensional measurement system based on observations of the radio signals of the NAVSTAR Global Positioning System. The GPS observations or data gathered are processed to determine station positions in Cartesian coordinates (x, y, z), which can be converted to geodetic coordinates (Latitude and longitude, and height-above reference ellipsoid). With adequate connections to vertical control network points and determination of the height of the geoid, orthometric heights or elevations can be computed for the points with unknown elevations. GPS provides higher accuracy with shorter observation time than other surveying systems.

Following are excerpts taken from the Federal Geodetic Control Committee (Appendix A) Charting and Geodetic Services published preliminary document, entitled Geometric Geodetic Accuracy Standards and Specifications For Using Relative Positioning Techniques, Version 5.0, May 11, 1988 and reprinted with corrections August 1, 1989.

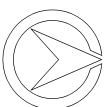

This is not a final document but could be used as a guideline for the planning and execution of geodetic surveys using GPS Relative Positioning Techniques.

The specifications in this document are presently limited to fixed or static mode of relating positioning survey operations. In the static mode receiver/antennas are not moving while data is being collected. Future versions of this document will include specifications for kinematic modes of operation where one or more receiver/antennas are moving (possibly stopping only briefly at survey points) while one or more other receivers are continuously collecting data at fixed locations.

#### 4-09.2 GPS Survey Standards And Specifications

Survey Standards are defined as minimum accuracies that are necessary to meet specific objectives, while Specifications are defined as field methods required to meet a particular standard.

- a. GPS Survey Standards: Table 4-4 shows the Geometric Relative Positioning Accuracy Standards for three-dimensional Surveys using space system techniques.

Assumptions and Criteria used in the development of GPS Accuracy Standards:

- Each component of the baseline determined by GPS Positioning Techniques are much alike, i.e., error sources that are highly correlated.
- Accuracy standards are not based on the technical training or ability of the surveyor, but instead they are based on the capabilities of the GPS measurement system.
- Normal time of data collection is 60 minutes to attain better results. Less than 30 minutes can increase risk of achieving unsuccessful observing sessions.
- Orders 1, 2, and 3 are grouped with a single set of criteria.
- There are two (2) "final" classifications for GPS Relative Positioning Survey Project.

First "Geometric" Classification, based on analysis of loop misclosures, repeat baseline results, and minimally constrained (free) least squares network adjustments. This classification is especially for high precision primary networks, deformation measurement investigations and other high precision Engineering surveys.

The second classification for a GPS project would be based on the results of a constrained 3-D adjustment where published coordinates for existing stations of the National Geodetic Reference System (NGRS) are either fixed or given weighted constraints. Relative position accuracy denotes the relative accuracy of the various components between one station and other stations of a network.

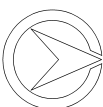

For the computation of the geometric relative position accuracy standard use the formula  $s = [(e^2) + (0.1pd)^2]^{1/2}$  (see Appendix B).

Where s = maximum allowable error in centimeters at 95% confidence level.

d = distance in kilometers between two stations.

p = minimum geometric relative position accuracy standard in parts per million (ppm) at the 95% confidence level.

e = base error in centimeters (this includes station-dependent setup error).

- Figure 4-5 is a graph of the maximum spherical or linear error at the 95% confidence level for each order and class of standards against the distance between any two stations.
- Appendix C is a tabulation of one-sigma minimum relative position accuracy standards given in Table 4-4.
- Appendix D is the expected minimum/maximum antennae set-up errors.
- Appendix E shows the elevation difference accuracy standards for geometric relative positioning techniques. Standards of accuracies for vertical control by spirit leveling should be different from those by GPS relative positioning and other 3-D geometric techniques. The height produced from GPS surveys are with respect to a reference ellipsoid. To convert these ellipsoid (also known as Geodetic) heights to orthometric heights or elevations, the survey must include adequate corrections to network control points with orthometric heights established by differential leveling techniques and referenced to the North American Vertical Datum of 1988 (NAVD 88).

- b. Network Design & Geometry Specifications: Table 4-5 summarizes the specifications for the network design and connection factors, including minimum station spacing, ties to existing horizontal and vertical network control points and direct connection requirements

Table 4-6 summarizes the minimum spacing between station-pairs for corresponding to relative position accuracies possible achieved from a GPS survey for a range of azimuth accuracy standards.

- c. Instrumentation Specifications:

- GPS Satellite geodetic Surveying equipment will consist of three(3) major components: the antennae, receiver/processor, and recording unit. Cable length from 10 to 60 meters.
- Dual frequency receivers are required for the most precise surveys to correct for the effects of ionospheric refraction.
- The receiver should have the capability to track a minimum of four (4) GPS satellites.

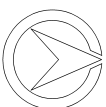



- codeless or have the capability to receive and decode the P and/or CA coded data.  
For codeless sets it is recommended that a high quality wrist watch be a
  - All GPS receivers should have a signal input port for an external
  - The height of the "phase" center ( $L$ ) or centers ( $L_1$  &  $L_2$ ) determined by the manufacturer plus the height of the reference point above the station will give the total used to reduce the baseline
- d. \_\_\_\_\_: The field calibration consists of testing the GPS equipment performance and the associated baseline processing software on a

- The three-dimensional test network should be composed of four or more
- Three-dimensional relative position measurements will be established to  $[(3 \text{ MM}) + (0.1 \text{ dppm})^2]^{1/2}$  at the 95% confidence level.  
The field procedures found in Table 4-7 for order B will be used to establish the test network.  
A special three-dimensional geodetic test network established by the Federal Geodetic Control Committee (FGCC) has been used to test GPS Maryland, about 40 kilometers Northwest of Washington, D. C.

Field Survey Procedures: The precision of the GPS vector baseline results

during an observing session, their geometric relationships, duration of the period when the desired number of satellites can be observed simultaneously, the ionospheric and tropospheric refraction, and the line

Table 4-7 summarizes the field procedures that should be allowed to achieve the desired accuracy standards. These field procedures are valid only for become available and processing techniques are refined.

Factors that affect the results are:

- Unexpected degraded accuracy for the orbital coordinates;
- Significant atmospheric disturbances;
- Receiver problems that went undetected before the survey team departs from project area.

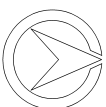

Stations located adjacent to high frequency, high-powered radar transmission antennae should be avoided.

- For all surveys, the antenna must be stably located over the station mark for the duration of the observations within the allowable antenna setup error specified in Appendix D.
- f. Office Procedure Specifications: Criteria for processing and determining the quality of GPS relative positioning results are as follows:
- (1) The cutoff angle for data points should be no greater than 20°.
  - (2) The point position (absolute) coordinates for the station held fixed in each single, session or network baseline solution must be referenced to the datum for the satellite orbital coordinates (ephemerides). This datum is now called the World Geodetic System 1984 (WGS-84) (DMA 1987).

In order of descending accuracies, the following are acceptable methods of estimating the fixed coordinates:

- (a) Point position reduction of the GPS observations using Doppler smoothed pseudorange (Code Phase) measurements.
  - (b) Point position coordinates determined from unsmoothed GPS pseudorange measurements.
  - (c) Point position reduction of Transit Doppler observations using the precise ephemerides and transformed to WGS-84.
  - (d) Use of NAD 83 published coordinates.
  - (e) Transformation of coordinates in a non-geocentric datum (e.g. NAD 1927) to the WGS-84 datum. In this method, the surveyor must be careful in obtaining transformation values that reflect with sufficient accuracy the differences between the non-geocentric local datum and the WGS-84 system.
- (3) Processing must account for the offset antennae phase center relative to the station mark in both horizontal and vertical components.
  - (4) As a rule of thumb, the number of simultaneous phase observations rejected (excluding those affected by cut-of angle and non-simultaneous observations) for a solution should be less than 5 percent for accuracy standards AA, A and B, and 10 percent for the remaining standards.
  - (5) Depending on the number of observations, quality of data, method of reduction, and length of base lines, the standard deviation of the range residuals in the base line solution should be between 0.1 and 2 CM for orders A, B, and 1; 1 to 4 CM for order 2; and, 1 to 8 CM for order 3.
  - (6) The maximum allowable formal standard errors for the baseline components may depend on the particular software. With proper weighting in a fixed orbit solution the values should be less than the expected accuracy for the orbit data. Typically this range within 2 CM for base lines with lengths at less than 50 KM.

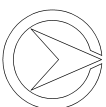

- g. Analysis & Adjustments: In practice, there will be two classifications for a GPS relative positioning survey. One would be based on the internal consistency of the GPS network adjusted independently of the local network control. This would be called the "geometric" classification. The second classification, if required, would be based on the results of a constrained adjustment where stations of the GPS survey network connected to the local network control are held fixed to vertical and horizontal coordinates in the "National Geodetic Reference System (NAVD 1988 and NAD 1983). This is referred to as the "NGRS" classification. Table 4-8 summarizes the specifications to aid in classifying the results for a GPS survey project.

Loop closures and differences in repeat base line measurements will be computed to check for blunders and to obtain initial estimates for the internal consistency of the GPS network. Error of closure is the ratio of the length of the line representing the equivalent of the resultant errors in the base line vector components to the length of the perimeter of the figure constituting the survey loop analyzed. The error of closure is valid for orders A and B surveys only when there are three or more independently determined base lines (from three or more observing sessions) included in the loop closure analysis. For orders 1 and lower, independently determined baselines from a minimum of two observing session (simultaneous observations) are not valid for analyzing the internal consistency of the GPS survey network.

After adjusting for any blunders, a minimally constrained (sometimes called a free least squares adjustment) should be performed and the normalized residuals examined.

The normalized residual is the residual multiplied by the square root of its weight, i. e. the ratio of the residual to the a priori standard error. Examining the normalized residuals helps to detect bad base line vectors. In the "free" adjustment, one arbitrary station is held fixed in all three coordinates and the four bias unknowns (3 rotations and one scale parameter) are set to zero values (Vincenty 1987). The observation weights should be verified as realistic by inspecting the estimate of the variance of unit weight, which would be close to 1. However, in practice, it may be higher, perhaps in the range of 3 to 5 because for a particular GPS baseline solution software, the formal errors from the base line solutions may be too optimistic.

Vector component (relative position) standard errors computed by error propagation between points in a correctly weighted minimally constrained least square adjustment will indicate the maximum achievable precision for the "geometric" classification. The constrained least squares adjustment will use models which account for: the reference ellipsoid for the network control, the orientation and scale differences between the satellite and network control datum's, geoid-ellipsoid relationships, the distortions and/or reliability in the network control, and instability in the control network due to horizontal and/or vertical deformation. A survey variance factor ratio will be computed to aid in determining the "NGRS" classification of the adjustment. The classification

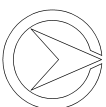

for the adjustment into the NGRS should not exceed the order for the combined control network.

The constrained adjustment determines the appropriate orientation and scale corrections to the GPS Base line vectors so it will conform to the local network control. Because of possible significant inconsistencies in the network control between sections of the project area, it may be necessary to compute several sets of orientation and scale corrections. This is done by dividing the project area into smaller "bias groups", provided that in each such group there is sufficient existing control with adequate distribution that is tied to the GPS network (Vincenty 1987).

If reliable geoid height data are available, the adjustment to determine elevations should be done in terms of heights above the ellipsoid. However useful estimates for elevations above mean sea level can be determined if geoidal height data are not available by fixing in an adjustment at least three stations with elevations. The stations with elevations must be well-distributed to permit fitting a plane through the three heights. The effect of ignoring the slope means that the geoidal slope is absorbed by two rotation angles (around the north and east axes in a horizon system) and geoidal heights are absorbed by the scale correction in a constrained 3-D adjustment (Vincenty). If there is one or more significant changes in the geoidal slope within the project area, the project can be divided into smaller "bias groups", provided there is at least three vertical control stations appropriately distributed within the "bias group" area.

The discussion related to "bias group" points out the importance in the planning for a GPS survey project to insure there is included in the survey adequate connections to the horizontal and vertical control network.

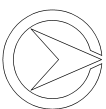

**Geometric Relative Positioning Accuracy Standards for Three-Dimensional**

SURVEY CATEGORIES	ORDER	(95 PERCENT CONFIDENCE LEVEL) MINIMUM GEOMETRIC		
		BASE ERROR	LINE-LENGTH DEPENDENT ERROR	
			e (cm)	p (ppm)
		<i>Global-regional geodynamics; deformation measurements</i>	AA	0.3
<i>National Geodetic Reference System, "primary" networks; regional-local geodynamics; deformation measurements</i>	A	0.5	0.1	1:10 000 000
<i>National Geodetic Reference System, "secondary" networks; connections to the "primary" NGRS network; local geodynamics; deformation measurements; high-precision engineering surveys</i>	B	0.8	1	1:1 000 000
<i>National Geodetic Reference System (Terrestrial based); dependent control surveys to meet mapping, land information, property, and engineering requirements</i>	(C)			
	1	1.0	10	1:100 000
	2-I	2.0	20	1: 50 000
	2-II	3.0	50	1: 20 000
	3	5.0	100	1: 10 000

Note: For ease of computation and understanding, it is assumed that the accuracy for each component of a vector base line measurement is equal to the linear accuracy standard for a single-dimensional measurement at the 95 percent confidence level. Thus, the linear one-standard deviation (s) is computed by:

$$s = \pm [\sqrt{e^2 + (0.1d.p)^2}] / 1.96. \quad (\text{See Appendix B})$$

Where, d is the length of the baseline in kilometers. 5-26-88

(GLOBAL POSITIONING SYSTEM (GPS) Standards and Specifications By the Federal Geodetic Control Committee (Version # 5.0). Reprint.)

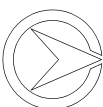
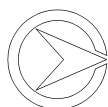

**Table 4-5: Guidelines for Network Design, Geometry and Connections**

GEOMETRIC ACCURACY STANDARDS	GROUP	AA	A	B	C
	ORDER	AA	A	B	1,2-I&II,3
	ppm	0.01	0.1	1.0	10,20,50,100
	BASE (cm)	0.3	0.5	0.8	1 2 3 5
<b>Horizontal network control of NGRS<sup>(a)</sup>, minimum number of stations</b>					
When connections are to orders AA, A or B		4	3	3	2
When connections are to order 1		na	na <sup>b</sup>	<sup>b</sup>	3
When connections are to orders 2 or 3		na <sup>b</sup>	na <sup>b</sup>	na <sup>b</sup>	4
<b>Vertical network control of NGRS<sup>(a)</sup>, minimum number of stations</b> <i>(c/d)</i>					
		5	5	5	4
<b>Continuous tracking stations (master or fiducials), minimum number of stations</b>					
		4	3	2	op
<b>Station Spacing (KM)</b>					
Between "existing network control" and CENTER of project:					
Not more than		110d	10d	7d	5d
50 percent not less than		$\sqrt{5}d$	$\sqrt{5}d$	$\sqrt{5}d$	d/5
Between "existing network control" located outside of project's outer boundary and the edge of the boundary, not more than		3000	300	100	50
<b>Location of network control</b>					
(relative to center of project); number of "quadrants", not less than					
		4	4	3	3
<b>Direct connections should be performed, if practical, between</b>					
Any adjacent stations (new or old, GPS or non-GPS) located near or within project area, when spacing is less than (KM)		30	30	10	5
<b>Legend:</b>					
d - is the maximum distance in (KM) between the center of the project area and any station of the project.					
NGRS - National Geodetic Reference System					
Confidence level					
CL - not applicable					
na - optional					
op -		4-17-89			
<b>Note:</b> If it is not practical to plan a survey that is within the criteria, minor adjustments may be provided that it is authorized by the agency requesting the survey.					
<b>Remarks:</b>					
a) Consult National Geodetic Survey officials whenever it is necessary to consider exceptions to these criteria, particularly, when the GPS survey project data are to be submitted to NGS for incorporation in the NGRS. If a survey with an accuracy standard of AA, A, or B is specified and one objective in the survey is to upgrade the existing network, then connections to a minimum of four stations are required or at least one station in each one-degree block with a minimum of four stations.					
c) First choice is vertical network control established and/or maintained by the National Geodetic Survey. When it is not possible to occupy the minimum number of NGRS points, non-NGRS control points may be used. This should be documented in the project report.					
d) If it is expected that the constrained adjustment for determination of the elevations within the project area will be based on more than one "bias group" (see discussion under section on Office procedures, Analysis and Adjustments) then the minimum number of stations specified is that which is required within the area for each "bias group". For example, if there two bias groups and ties required to four bench marks, then four bench marks will be incorporated within each area of the "bias group" for a total of 8 bench marks.					

5-09-88

(GLOBAL POSITIONING SYSTEM (GPS) Standards and Specifications By the Federal Geodetic Control Committee (Version # 5.0). Reprint.)



**Table 4-6: Guidelines for Minimum Spacings for Establishing Pairs of Intervisible Stations to Meet Azimuth Reference Requirements**

SPACING BETWEEN A "PAIR" OF STATIONS, NOT LESS THAN  (METERS)	AZIMUTH ACCURACY REQUIRED IN SECONDS OF ARC (95 PERCENT CONFIDENCE LEVEL)				
	1	2	4	6	10
	GPS RELATIVE POSITION PRECISION (MM) (95 PERCENT CONFIDENCE LEVEL)				
100	-	-	2	3	5
200	-	2	4	6	10
300	-	3	6	9	14
400	2	4	8	12	19
500	3	5	10	14	24
600	3	6	12	18	29
<i>Example:</i>	If the expected relative position precision from a GPS survey between two marks spaced less than 1 000 meters apart is 2 MM at the 95 percent confidence level, then to achieve an azimuth accuracy of 2 seconds at the 95 percent confidence level, the minimum spacing between the pair of stations is 200 meters. 1-01-86				

(GLOBAL POSITIONING (GPS) Standards and Specifications By the Federal Geodetic Control Committee. (Version # 5.0). Reprint.)

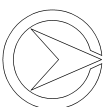
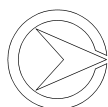

Table 4-7: Guidelines for GPS Field Survey Procedures

GEOMETRIC RELATIVE POSITIONING STANDARDS	GROUP	AA	A	B	C
	ORDER		A	B	
	ppm		0.1	1.0	
<b>Two frequency observations (1 and L2) required<sup>(a)</sup></b> (b)		Y		Y	op
		5	5		3
<b>Satellite Observations</b> (d)		[TO BE ADDED IN FUTURE VERSION]			
[4 or more simultaneous satellite observations] <sup>(e)</sup> (f)		na		240	60-120
(g), (b)(i)		240	240	120	30-60
Continuous and simultaneous between all receivers, period not less than <sup>(j)(i)</sup>			120	60	
Data sampling rate - maximum time interval between observations (sec)		15		30	15-30
		4	4		3 or 2 <sup>(k)</sup>
Maximum angle above horizon for obstructions <sup>(v)</sup>		10	15		20-40
<b>Independent occupations per station (1)</b>		80	40		10
Two or more (% of stations, not less than):					
New stations		100	80	50	
Vertical control stations		100		100	100
		100	75		25
Two or more for each station of "station-pairs" <sup>(M)</sup>		Y	Y	Y	Y
<b>Master of fiducial stations (n)</b>		Y	Y		op
If yes, minimum number			3	2	
<b>Repeat base line measurements</b>		25		5	5
of total independently [nontrivial] determined base lines).					
<b>[NOTE: Also, see Table 4-8]</b>					
Base lines from independent observing sessions, not less than			3	2	
Base lines in each loop, total not more than			8	10	
Loop length, generally not more than (KM)		2 000		100	100
all independent nontrivial lines (p)]		0		20	30
stations)		0		10	15
Between ANY adjacent (NGRS and/or new GPS) stations (new or old, GPS or non-GPS) stations or within project area, when spacing is less than (KM)			10	5	
<b>Antenna setup</b>					
Number of antenna phase center height measurements per session, not less than			3 (q)	2	
		Y	Y		op
<b>Photograph (</b>					
required for each mark occupied		Y		Y	Y
Per observing session, not less than		3 (s)		2 (t)	
Sampling rate (measurement interval), not more than (min)		30		60	60
at selected stations?		op		N	N
Crystal		12		(u)	(u)
		1	1		(t)

(GLOBAL POSITIONING SYSTEM (GPS) Standards and Specifications By the Federal Geodetic Control Committee (Version #

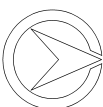



**Table 4-7: Guidelines for GPS Field Survey Procedures (cont.)**

<b>Legend:</b>	nr - not required, na - not applicable, op - optional
<b>Remarks:</b>	<p>(a) If two-frequency observations can not be obtained, it is possible that an alternate method for estimating the ionospheric refraction correction would be acceptable, such as modeling the ionosphere using two-frequency data obtained from other sources. Or, if observations are during darkness, single frequency observations may be acceptable depending on the expected magnitude of the ionospheric refraction error.</p> <p>(b) When spacing between any two stations occupied during an observing session is more than 50 KM, two frequency observations may need to be considered for Accuracy Standards of Order 2 or higher</p> <p>(c) Multiple baseline processing techniques.</p> <p>(d) Studies are underway to investigate the relationship of Geometric Dilution of Precision (GDOP) values to the accuracy of the base line determinations. Initial results of these studies indicate there is a possible correlation. It appears the best results may be achieved when the GDOP values are changing in value during the observing session.</p> <p>(e) The number of satellites that are observed simultaneously cannot be less than the number specified for more than 25 percent of the specified period for each observing session.</p> <p>(f) Absolute minimum criteria is 100 percent of specified period.</p> <p>(g) "Other" includes processing carrier phase data using single, double, nondifferencing, or other comparable precise relative positioning processing techniques.</p> <p>(h) The times for the observing span are conservative estimates to ensure the data quantity and quality will give result that will meet the desired accuracy standard.</p> <p>(i)</p> <p>(j) Absolute minimum criteria for the data collection observing span is that period specified for an observing session that includes continuous and simultaneous observations. Continuous observations are data collected that do not have any breaks involving <u>all</u> satellites; occasional breaks for individual satellites caused by obstructions are acceptable, however, these must be minimized. A set of observations for each measurement epoch is considered simultaneous when it includes data from at least 75 percent of the receivers participating in the observing session.</p> <p>(k) Satellites should pass through quadrants diagonally opposite of each other.</p> <p>(l) Two or more independent occupations for the stations of a network are specified to help detect instrument and operator errors. Operator errors include those caused by antenna centering and height offset blunders. When a station is occupied during two or more sessions, back to back, the antenna/tripod will be reset and replumbed between sessions to meet the criteria for an independent occupation. To separate biases caused by receiver and/or antenna equipment problems from operator induced blunders, a calibration test may need to be performed.</p> <p>(m) Redundant occupations are required when pairs of intervisible stations are established to meet azimuth requirements, when the distance between the station pair is less than 2 KM, and when the order is 2 or higher.</p> <p>(n) Master or fiducial stations are those that are continuously monitored during a sequence of sessions, perhaps for available for use in processing with data collected with the mobile units.</p> <p>(o) adjusting one or more components of the orbit, then two or more master stations shall be established.</p> <p>(p) simultaneously during a session, e.g. if there were 10 sessions and 4 receivers used in each session, 30 independent base lines would be observed. (see Appendix F)  A measurement will be made both in meters and feet, at the beginning, mid-point, and end of each station occupation.  To ensure the antenna was centered accurately with the optical plummet over the reference point on the marker, when specified, a heavy weight plumb bob will be used to check that the plumb point is within specifications. Measurements of station pressure (in millibars), relative humidity, and air temperature (in C) will be recorded at the beginning, midpoint, and end depending on the period of the observing session.  Report only unusual weather conditions, such as major storm fronts passing over the sites during the data collection period. This report will include station pressure, relative humidity, and air temperature.  The amount of warm-up time required is very instrument dependent. It is very important to follow the manufacturer's specifications.  An obstruction is any object that would effectively block the signal arriving from the satellite. These include buildings, trees, fences, humans, vehicles, etc.</p>

5.0). Reprint.)



**Table 4-8: Office Procedures for Classifying GPS Relative Positioning Networks Independent of Connections to Existing Control**

GEOMETRIC RELATIVE POSITIONING STANDARDS	Order ppm	AA	A 0.1	B 1.0	1	2-I 20	2-II 50	3
<b>Ephemerides</b>								
Orbit accuracy, minimum (ppm)		0.008		0.5	5		25	50
ephemerides required?.		Y	Y <sup>a</sup>		op	op		N
<b>Loop closure analyses (b)</b>								
criteria:								
Base lines in loop from independent observations		4	3		2	2		2
Base lines in each loop, total not more than		6	8	10	10	10	15	15
Loop length, not more than (KM)		2 000	300	100	100	100	100	100
Base lines not meeting criteria for inclusion in any lines)		0		5	20		30	30
misclosure not to exceed (CM)		10		15	25		50	100
In any component (X, Y, Z), "maximum" misclosure, in terms of loop length, not to exceed (ppm)			0.2	1.25		25	60	
In any component (X, Y, Z), "average" misclosure,		0.09	0.09		8	16		80
<b>Repeat base line differences</b>								
Base line length, not more than (KM)		2 000	2 000	500	250	250	100	50
In any component (X, Y, Z), "maximum" not to exceed (ppm)		0.01	0.1	1.0	10	20	50	100
<b>Minimally constrained adjustment analyses</b> [TO BE ADDED IN FUTURE VERSION]								
<b>Remarks:</b> (a) The precise ephemerides is presently limited to an accuracy of about 1 ppm. By late 1989, it is expected the accuracy will improve to about 0.1 ppm. It is unlikely orbital coordinate accuracies of 0.01 ppm will be achieved in the near future. Thus to achieve precisions approaching 0.01 ppm, it will be necessary to collect data simultaneously with continuous trackers or fiducial stations. (see criteria for field procedures, Table 4-7.) Then the all data is processed in a session or network solution mode where the initial orbital coordinates are adjusted while solving for the base lines. In this method of processing the carrier phase data, the coordinates at the continuous trackers are held fixed.								
(b) Between any combination of stations, it must be possible to form a loop through three or more stations which never passes through the same station more than once.								

(GLOBAL POSITIONING SYSTEM (GPS) Standards and Specifications By the Federal Geodetic Control Committee (Version # 5.0). Reprint.)

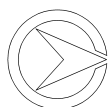

FIGURE 4-1: BRONZE DISK

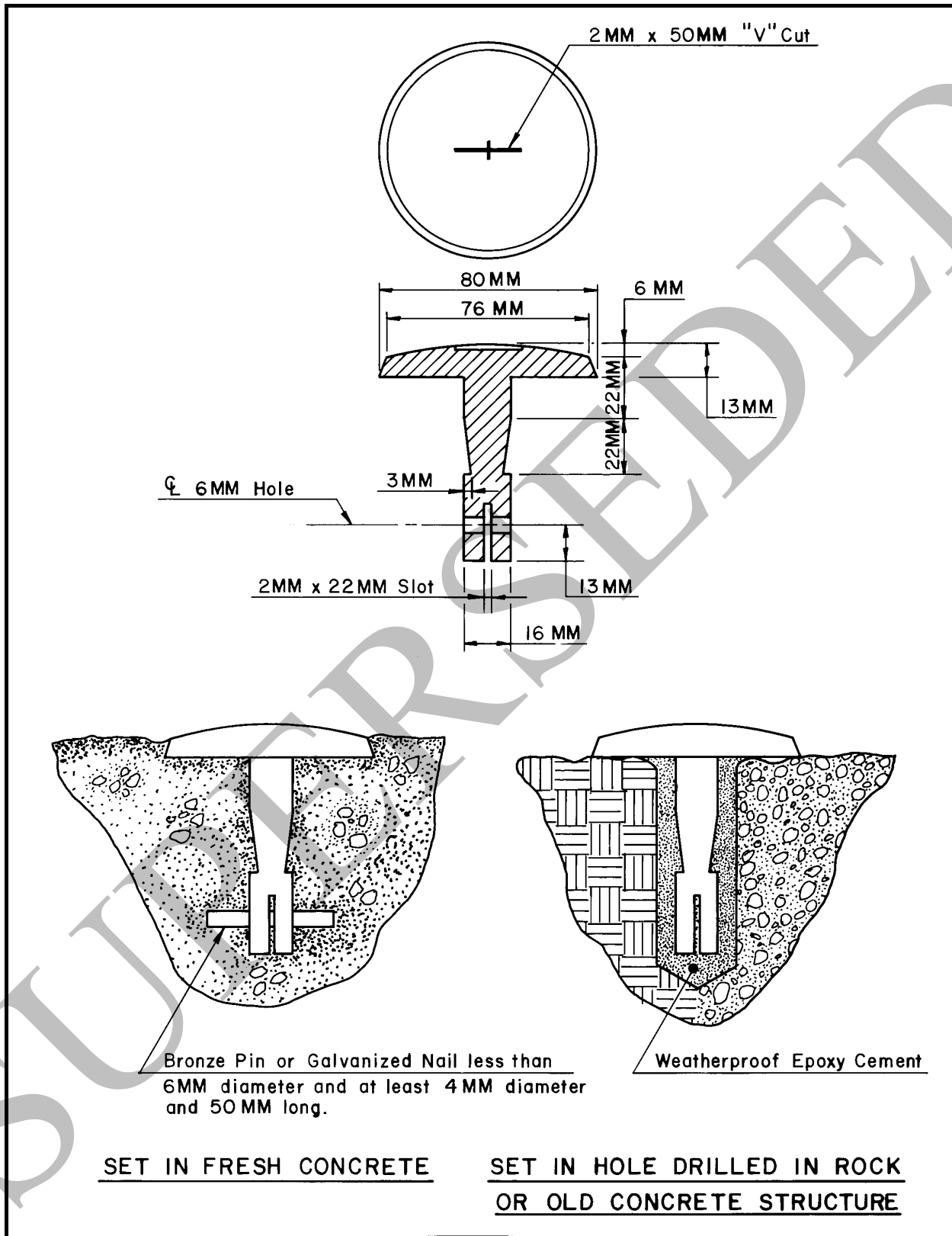
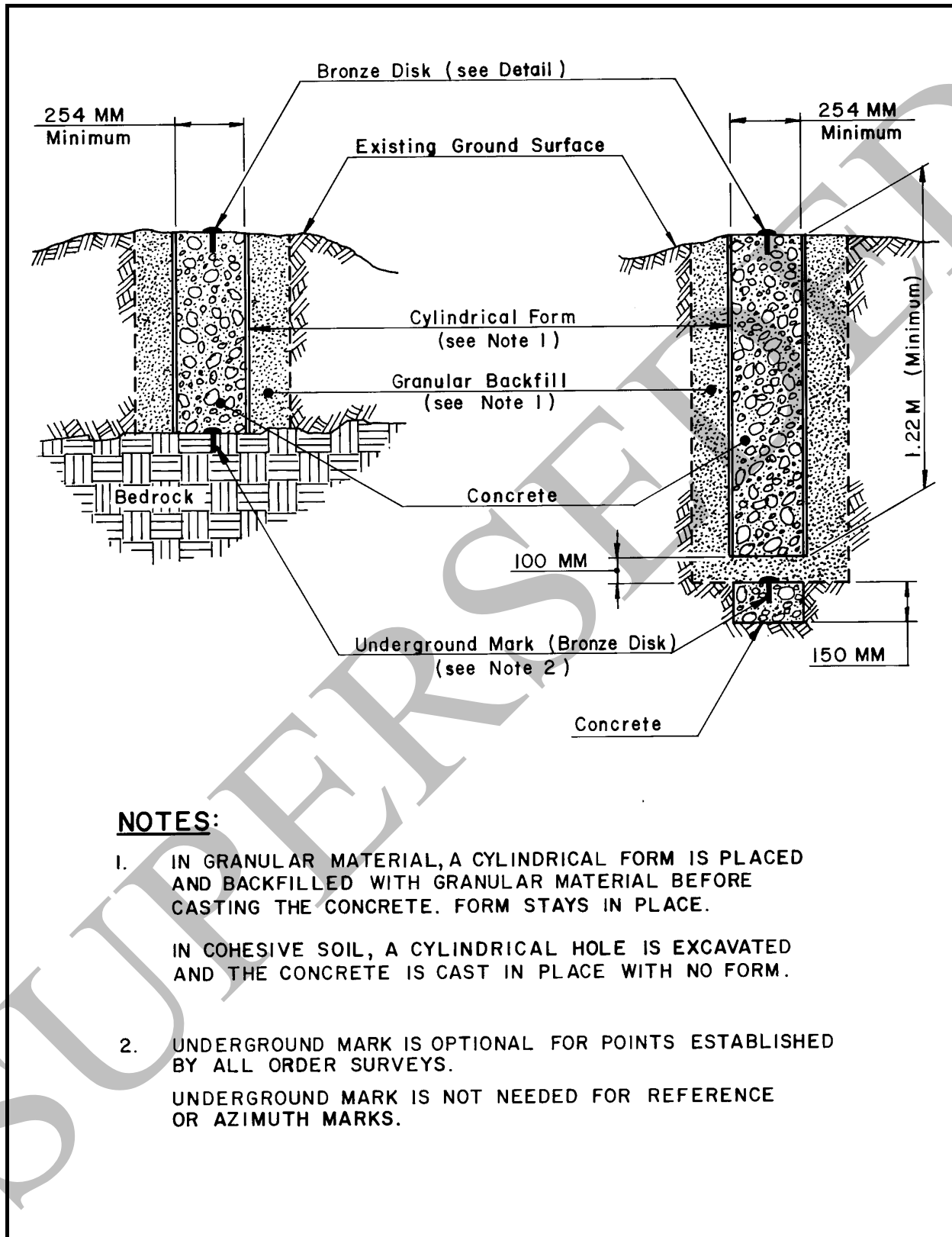

FIGURE 4-2: CYLINDRICAL CONCRETE MONUMENT

**NOTES:**

1. IN GRANULAR MATERIAL, A CYLINDRICAL FORM IS PLACED AND BACKFILLED WITH GRANULAR MATERIAL BEFORE CASTING THE CONCRETE. FORM STAYS IN PLACE.  
 IN COHESIVE SOIL, A CYLINDRICAL HOLE IS EXCAVATED AND THE CONCRETE IS CAST IN PLACE WITH NO FORM.
2. UNDERGROUND MARK IS OPTIONAL FOR POINTS ESTABLISHED BY ALL ORDER SURVEYS.  
 UNDERGROUND MARK IS NOT NEEDED FOR REFERENCE OR AZIMUTH MARKS.

FIGURE 4-3: DISK ON ROD

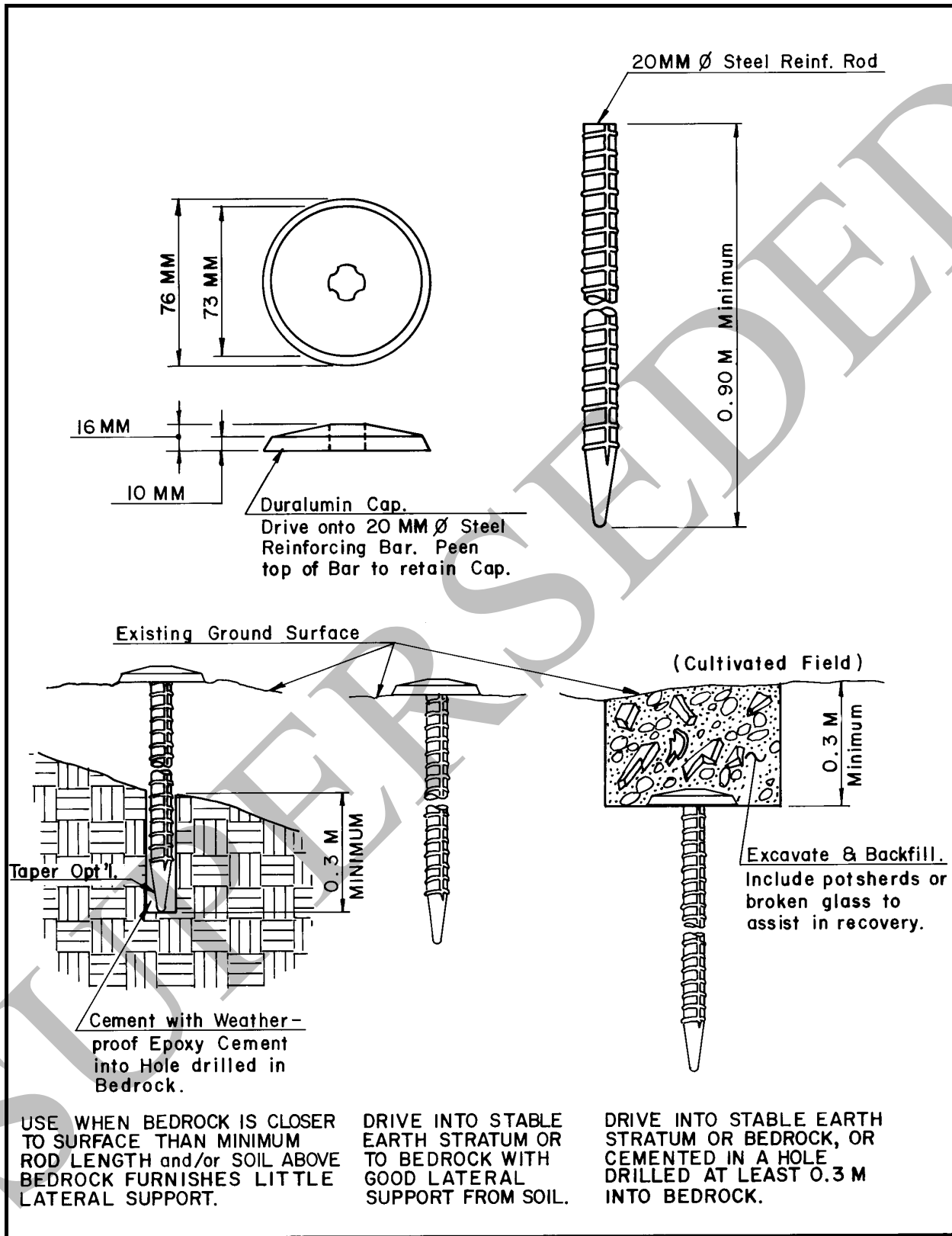

FIGURE 4-4: NGS 3-D MARKER

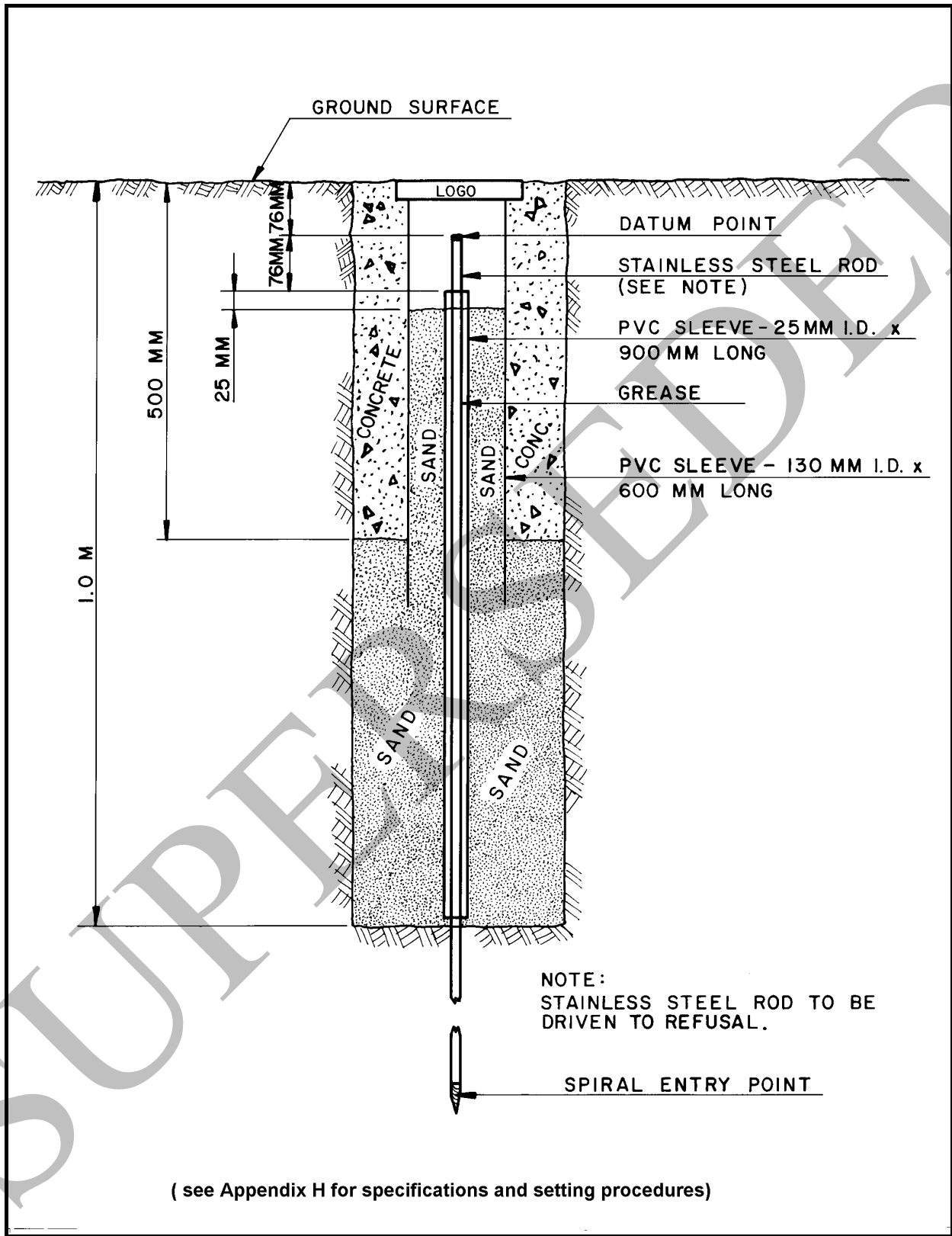
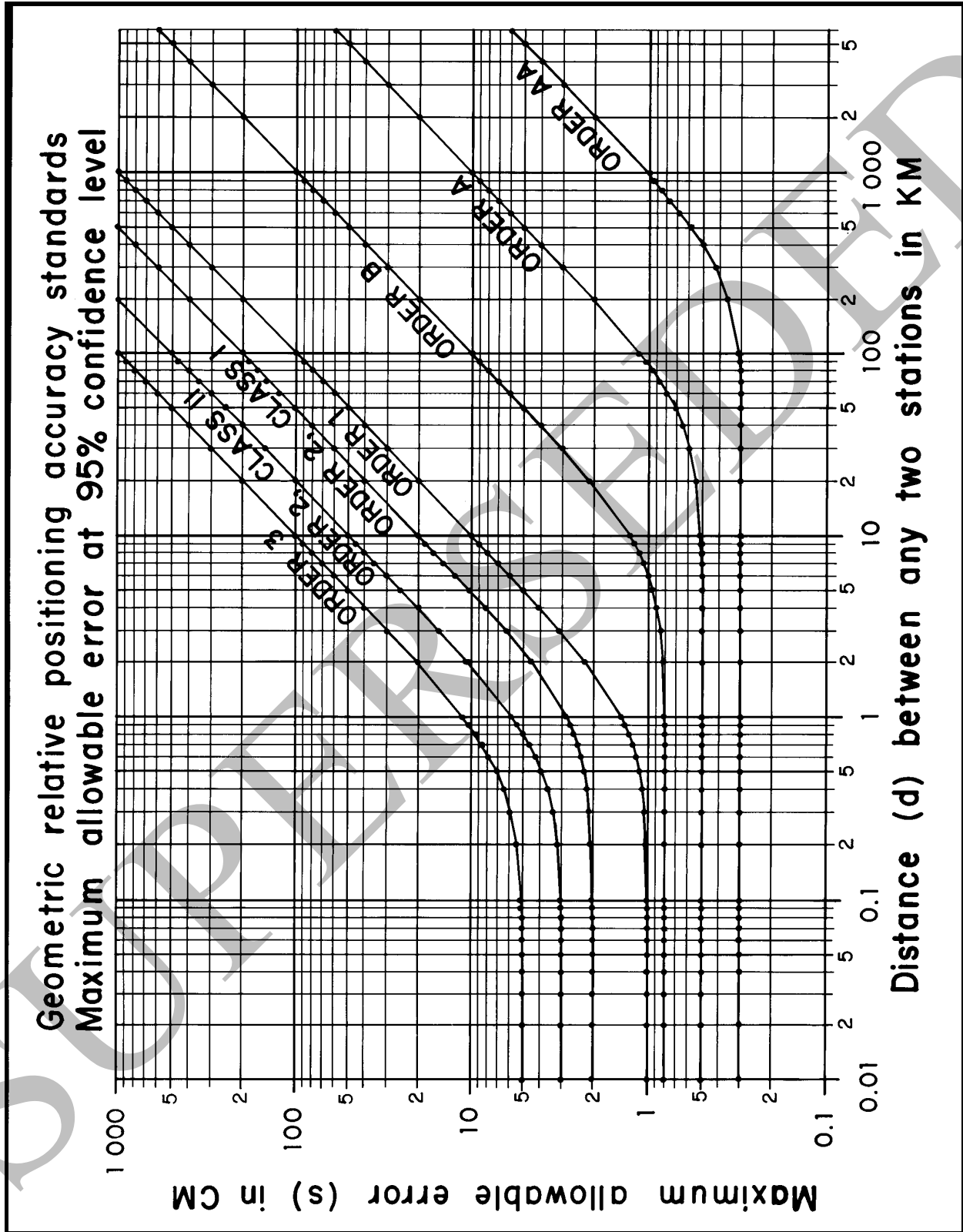

FIGURE 4-5: GEOMETRIC RELATIVE POSITIONING ACCURACY STANDARDS MAXIMUM ALLOWABLE ERROR AT 95% CONFIDENCE LEVEL



## SECTION 5

### PHOTOGRAMMETRIC MAPPING

#### 5-01 COMPILATION

##### 5-01.1 General

The Contractor shall compile one or more maps consisting totally or in part of map manuscripts, base plans, profiles, cross sections, or such comparable engineering documents as may be stipulated for the Project by the NJDOT. Unless stipulated otherwise by mutual agreement between the NJDOT and the Contractor, compilation shall be accomplished by employing a precise stereoscopic plotting instrument in which sequential exposures of aerial photographs are precisely oriented to form a three-dimensional optical model. From this model, the Contractor's photogrammetrist shall sight on and trace planimetric and/or topographic features which the plotting instrument shall then render automatically onto a map manuscript at the horizontal and/or vertical scale (s) specified by the NJDOT.

##### 5-01.2 Digital Map Compilation (see Section 6)

#### 5-02 AREA

The area to be mapped shall be as outlined on the Project key map and shall include any revisions or increases, or exclude any decreases, as may be subsequently specified by the NJDOT while the mapping is in progress.

#### 5-03 MAP MANUSCRIPT

Map manuscripts shall be drawn on sheets made from a dimensionally stable polyester-type plastic transparent film having a minimum thickness of one tenth of a millimeter (0.10 MM). All map detail shall be clearly and accurately depicted so that the manuscript shall be capable of producing finished maps which fulfill all specification requirements. All manuscripts prepared under this Project shall be available for inspection by the NJDOT at all times. Reproducible sepia or mylar copies of the manuscripts shall be submitted to the NJDOT prior to finalizing by the Contractor for such field editing and selection of additional labeling of planimetric detail as the NJDOT may require. The manuscript scale and the scale of the finished maps shall be the same.

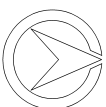



## 5-04 TOPOGRAPHIC MAPS FOR DESIGN

### 5-04.1 Plane Coordinate Grid Lines

Grid lines representing the New Jersey State Plane Coordinate System shall be delineated on all map manuscripts and finished maps. Grid lines shall be drawn as solid lines at a spacing of one hundred millimeters (100 MM).

Numerical values (coordinates) for grid lines shall be labeled at the top, bottom and sides of each sheet, approximately twenty five millimeters (25 MM) inside the border and immediately adjacent to their corresponding grid lines.

Whenever the NJDOT stipulates that ground control surveys shall not be tied to survey monuments of the New Jersey State Plane Coordinate System, an alternate system for plane coordinates shall be established by the Contractor, subject to approval by the NJDOT, and it shall be made readily distinguishable from the New Jersey State Plane Coordinate System.

### 5-04.2 Match Lines, Title Blocks and North Arrows

Match lines shall be provided on all map sheets so that each sheet may be joined accurately to those adjacent.

A title block shall be placed on each map sheet to the size and layout required by the NJDOT.

A New Jersey State Plane Coordinate north arrow shall be suitably placed and oriented on each map sheet.

### 5-04.3 Current Data

All maps prepared by the Contractor shall be up-to-date with regard to planimetric and topographic features as of sixty (60) days prior to the acknowledgment date of delivery to the NJDOT.

### 5-04.4 Planimetry

Subject to the guidelines specified in Table 5-1, all finished maps shall contain the planimetric features which are identifiable on and interpretable from corresponding aerial photographs. Such features shall include, but not necessarily be limited to, the following: buildings, commercial agricultural fields, orchards, cemeteries, parks, golf courses and other recreational areas; utility transmission lines, poles, towers, fence lines and logged-off areas, roads, railroads, billboards, underground cables, pipelines, sewers and other utility facilities; quarries, borrow pits, ledge rocks, cliffs, wooded areas, individual trees and decorative shrubs that can be recognized as such at the specified scale, rock and other walls; swales, creeks, rivers, tributary systems, pools, wells, falls, aqueducts, lakes, the ocean, bays wetlands, fords, ferry slips and any other pertinent details of land features.

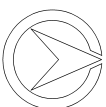

Each water course and drainage way shown on the map shall be an accurate depiction of its counterpart in the field. All such water courses shall be denoted by a dash-and-three-dot symbol in all well-defined drainage features as indicated by the contours. Streams and drainage ditches averaging more than two and one half millimeters (2.5 MM) wide at map scale shall be shown by two symbolized lines spaced and properly delineated in correct position to represent the respective water edges; all other streams and ditches shall be represented by a single symbolized line. All water courses shall be stopped at a distance of thirty meters (30 M) from the ridge lines, [and water courses under sixty meters (60 M)] in length or which measure less than twenty five millimeters (25 MM) at map scale, need not be shown.

Buildings, bridges and similarly dimensionable objects shall be correctly outlined and oriented, and they shall be drawn to actual scale size except for those horizontal dimensions that are smaller than representable by two and one half millimeters (2.5 MM) in size. Minor irregularities in building outlines not representable by one and three tenths of a millimeter (1.3 MM) at map scale shall be ignored. Large buildings such as schools, institutions, barns, warehouses, factories and industrial plants should be crosshatched for clarity.

Structures such as bridges, trestles, tunnels, piers, wharves, smokestacks, silos, towers, abutments and wingwalls, retaining walls, viaducts, dams, power plants, transformer and other substations terminals and airfields, oil, water and other storage tanks, petroleum refineries and any other such items, shall be shown.

All corporate (city, township, county, state and any other political subdivision) lines shall be shown. The Contractor shall be responsible for ascertaining the current and correct locations of these lines and accurately delineating them onto their corresponding maps. The same responsibility shall apply to rivers, streams, railroads, all State, Federal, Interstate and County roadways, principal streets and other features of comparable importance.

Curbed roadways shall be shown with pairs of solid lines spaced at sixty-four hundredths of a millimeter (0.64 MM) at map scale, representing the curbing, and defining each roadway edge where curbing exists. All uncurbed paved roadways without shouldering shall be shown with single solid lines defining each pavement edge.

Uncurbed roadways with shoulders shall be represented with uniformly dashed lines denoting the pavement edge wherever shoulder pavement is encountered. Trails shall be indicated by a single uniformly dashed line representing the centerline of each trail.

On maps scaled to 1:500 or larger, there shall be shown where they occur, in addition to all the aforementioned land use features, parking strips and lots, driveways, hydrants, gasoline pumps and islands, manholes, inlets and catch basins, water and gas meter box covers, culverts, wells, distinct hedges, ornamental bushes and shrubs, trees, signs, steps, lamp posts, luminaires, traffic signals and their corresponding

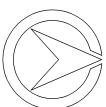

control boxes, junction boxes, below-ground pools and fountains, large permanent-type above-ground pools, and any other such features identifiable on aerial photographs.

The outlines of wooded areas shall be carefully and accurately delineated and shown in correct position. Special care shall be given to show tree lines adjacent to roads, railroads and prominent water courses. The cleared widths of overhead transmission line Rights-Of-Way shall also be shown in correct position.

**Table 5-1 Map Scale Standards (Planimetry to be shown except as noted)**

PLANIMETRIC DETAIL	1:500 & LARGER	1: 1000	1: 2 000
<i>Airports and Runways</i>			
<i>Athletic Fields</i>			
<i>Billboards</i>			
<i>Borrow Pits</i>		(7)	(1)
<i>Boulders and Rocks</i>	(5)	(3)	(1)
<i>Bridges and Viaducts</i>			
<i>Buildings</i>			(8)
<i>Bushes and Shrubs</i>		(6)	(1)
<i>Canals and Creeks</i>			
<i>Catch Basins and Inlets</i>		(1)	(1)
<i>Cemeteries</i>			
<i>Churches</i>			
<i>Crib and other Retaining Walls</i>		(2)	(3)
<i>Culverts</i>		(9)	(9)
<i>Curbs</i>		(1)	(1)
<i>Dams</i>			
<i>Ditches and Channels</i>			(4)
<i>Drains</i>			
<i>Drives</i>			
<i>Fences</i>		(11)	(11)
<i>Ferry Slips</i>		(2)	(4)
<i>Field Roads</i>			
<i>Flood Plains (Boundaries)</i>			(2)
<i>Fords</i>			
<i>Foundations</i>			
<i>Gas Pumps and Islands</i>			
<i>Golf Courses</i>		(1)	(1)
<i>Greenhouses</i>			
<i>Guiderails and Attenuators</i>		(2)	(1)
<i>Hedges</i>		(2)	(4)
<i>High Tension Lines</i>			
<i>House Trailers (Permanent)</i>			(8)
<i>Hydrants</i>		(1)	(1)
<i>Lakes and Ponds</i>		(1)	(1)
<i>Lamp Posts (Private)</i>			
<i>Light Poles</i>		(1)	(1)
<i>Mailboxes</i>		(1)	(1)
<i>Manholes</i>		(1)	(1)
<i>Marshes and Swamps</i>			
<i>Mines</i>			

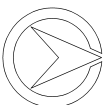
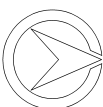

**Table 5-1 Map Scale Standards (Planimetry to be shown except as noted) (cont.)**

PLANIMETRIC DETAIL	1:500 & LARGER	1: 1000	1: 2 000
<i>Nurseries and Orchards</i>			(2)
<i>Parking Areas and Lots</i>			
<i>Parking Meters</i>			(2)
<i>Patios and Porches</i>		(1)	(1)
<i>Piers, Wharves and Docks</i>		(1)	(1)
<i>Pipe Lines (Utility)</i>			
<i>Poles (Utility)</i>			(4)
<i>Pools (In-ground)</i>		(4)	(4)
<i>Quarries</i>			
<i>Radio Towers</i>			
<i>Railroads - Rails</i>		(12)	(12)
<i>Railroads: Switches, Signal Boxes, Power Stations, Bumpers</i>		(1)	(1)
<i>Rapids</i>			
<i>Recreation Areas and Parks</i>			
<i>Reservoirs</i>			
<i>Rivers and Tributaries</i>			
<i>Roads</i>			
<i>Road Shoulders</i>		(1)	(1)
<i>Rock Outcrop</i>		(2)	(2)
<i>Ruins</i>			
<i>Schools</i>			
<i>Sidewalk</i>		(2)	(1)
<i>Signs</i>		(7)	(3)
<i>Silos</i>			
<i>Smokestacks</i>			
<i>Springs</i>			
<i>Steps</i>		(10)	(1)
<i>Storage Tanks</i>			
<i>Streams</i>			
<i>Substations (Transformers)</i>			
<i>Towers</i>			
<i>Traffic Lights</i>		(1)	(1)
<i>Trails</i>			(11)
<i>Transportation Terminals</i>			
<i>Trees (Individual)</i>			
<i>Trestles</i>		(5)	(3)
<i>Tunnels</i>			
<i>Utility Valve and Meter Caps (As Specified)</i>			
<i>Walls</i>		(3)	(3)
<i>Waterfalls (Wells)</i>		(2)	(3)
<i>Woods (Boundaries)</i>		(1)	(1)
<b>Notes::</b>	(1) Details not to be shown at this scale. (2) Prominent only. (3) Landmark only. (4) Cross country only. (5) Shown if over 3 meters in diameter. (6) Ornamental only.	(7) Large only. (8) Larger than a one car garage. (9) On drainage plan only. (10) For Large Public Buildings only. (11) <u>Prominent</u> : Over 25 millimeters long at map scale. (12) Centerline of track only.	

### 5-04.5 Topographic Details

When topographic maps are required by the NJDOT, such maps shall contain all representable topographic features so designated by the NJDOT which are identifiable of or interpretable from the corresponding aerial photographs.



Where they occur, such features shall include, but not necessarily be limited to, the following: all drainage ways of draws, creeks, rivers, and tributary streams, springs, falls and rapids, ponds and lakes, floodplains, swamps, marshes, bogs and other sites that can be considered as wetlands; also any ledge rock cliffs and other topographic features which the NJDOT may require for layout and design purposes shall be represented on the maps.

On maps scaled at 1:1 000 or larger, they shall be shown and identified as such where they occur, large surface boulders and rock outcrops protruding from the ground, correctly located and outlined, whose minimum representable plan view dimensions at map scale are no less than two and one half millimeters (2.5 MM) in size. Their heights above ground shall also be indicated.

- a. Contours: Within accuracy requirements, contours shall be delineated to represent the exact shape of the ground and its true elevation above the North American Vertical Datum of 1988. Solid line contours shall be shown on the final maps in all areas where the ground can be clearly seen on the three-dimensional optical (stereoscopic) model. When the ground is obscured, the Contractor either shall show the corresponding contours with dashed lines, or he shall utilize spot elevations as determined photogrammetrically in locations where the ground is visible.
- b. Spot Elevations: Photogrammetrically ascertained spot elevations shall be shown on the final maps in proper position at water level on the shorelines of pertinent bodies of water, on hilltops, in saddles, at the low point of depressions, the at-grade intersections of principal traveled ways such as highways, main streets, railroad crossings and the like, and on the centerline at each end of bridges and other comparable structures. Where contours are more than seventy six millimeters (76 MM) apart at final map scale, spot elevations shall be shown at sufficient intervals so that they are not separated by more than fifty one millimeters (51 MM) at final map scale from the nearest spot elevation or contour.
- c. Underground Utilities: When required by the NJDOT, the Contractor shall research all data on any underground utilities within the project limits and shall show them on the corresponding maps as to type, size and location.

Such utilities may include, but not necessarily be limited to, cables and conduits, drainage basins, pipelines, subway systems, underground septic, fuel and other storage tanks, runoff and sewer systems whose recorded invert elevations shall be accurate to the nearest ten (10) millimeters and any springs, wells and reservoirs, denoting type, size and location. A reference providing the source of data of all underground utilities shown on each sheet shall be reported along the lower edge and inside the border of that sheet.

- d. Drainage: The following data shall be obtained in the field and shown on the maps for all drainage system structures: type, size, material, and inlet and outlet invert elevations. With the exception of flowline data, the same data shall be obtained for all pertinent bridge and drainage system structures situated beyond the project limits which would still influence the design of the proposed

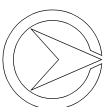

roadway structures. All invert elevations shall be accurately ascertained and recorded on the maps to the nearest ten (10) millimeters.

#### 5-04.6 Plan Production Specifications

All maps required by the NJDOT shall be rendered on reproducible sheets consisting of plastic film as described in Section 5-03.

- a. Layout Prerequisites: On projects with east-west flights, the corresponding map sheets shall begin at the western terminus of the project and be numbered consecutively from west to east. On projects with north-south flights, the corresponding map sheets shall begin at the southern terminus and be numbered consecutively from south to north.

The Contractor shall prepare the map manuscript stipulated by the NJDOT in such a way that all weights and gauges of symbols, size and style of lettering and/or type arrangement, and all treatment of marginal annotations, sketches and diagrams incorporated thereon, shall conform to the prerequisites set forth in these Specifications. Such compliance maps shall serve as source documents for the preparation of base maps which shall be sufficiently lucid and reliable and which otherwise shall fulfill all Specification requirements so that all subsequent contact prints made therefrom shall contain neat, legible nomenclature and precise symbol definition at the prescribed scale.

Professional standards of draftsmanship shall be maintained throughout the preparation of all map and plan sheets. Each line, whether solid or symbolized in format, shall be uniform in width and tone for its entire length. The width of fine lines shall not be less than thirteen hundredths of a millimeter (0.13 MM), and that of heavy lines shall not be greater than one and three tenths of a millimeter (1.3 MM). All ground features representable with lines and symbols shall be drawn or scribed with the aid of a straight-edged, curved or other specialized template where appropriate. All graphic representations employed to denote major ground features shall employ the standard and supplemental NJDOT map symbols and plan nomenclature according to Figures 1-1A, 1-1B, 1-1C, and 1-2.

- b. Contours: Where required by the NJDOT, all contour lines shall be uniformly drawn or scribed as a solid line except for those areas where the ground is obscured on the aerial photographs. In such ground-hidden places, the contours shall be represented by uniformly dashed lines having the same thickness as solid line contours.

In addition, the Contractor shall make use of photogrammetrically ascertained spot elevations at any locations where the ground is visible in the aerial photographs. Contours shall not be drawn or scribed through letters or numbers which are smaller than six and four tenths of a millimeter (6.4 MM) in height at map scale.

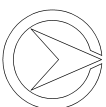

To render index contours distinguishable from intermediate contours, every fourth or fifth contour, depending on map scale used, shall be drawn or scribed as heavier line, solid or dashed where appropriate. Each resulting index contour shall be identified and labeled according to its actual elevation above the North American Vertical Datum of 1988. Whenever index contours are closer to each other than six and four tenths of a millimeter (6.4 MM) at map scale and the ground between them is a uniform slope, intermediate contours may be omitted. Where the intermediate slope is not uniform, such an omission will not be permissible unless the contours are shown at changes in ground slope.

- c. **Lettering:** The current and correct names of corporate and political entities, prominent water courses, principal roadways and streets, railroads, government offices, major schools and institutions, parks, cemeteries and other ground features of like importance, shall all be ascertained by the Contractor.

All such names, numbers and any accompanying notes and references shall be professionally lettered onto the maps. The same care shall be given in lettering all official highway designations, existing utility lines, invert elevations, grid line coordinates, baselines, monuments, bench marks and related station markers. All lettering shall be neat and clear in meaning and shall not obstruct any map features or symbols.

- d. **Inspection and Editing:** All map manuscripts and finished maps shall be available for inspection by the NJDOT at all times. When required by the NJDOT, said maps shall be delivered to the NJDOT for field-editing. The size and type of all planimetric features identifiable from aerial photographs and the size, type and location of such features not identifiable on nor discernible from aerial photographs, shall then be furnished by the NJDOT for incorporation onto the maps prior to finalization by the Contractor.

#### 5-04.7 Finished Maps

All finished maps shall be rendered on plastic film as described in Section 5-03. Such maps shall be reproducible by any of the standard printing processes so that all lines and all other map details and descriptive texts and symbols will be neat, clear and legible. These map sheets shall be approximately 540 MM long by 775 MM wide between the inside border lines unless prescribed otherwise by the NJDOT. On the other hand, for a given project, the NJDOT may direct that the maps be prepared in rolls of various lengths with a 762 MM maximum width.

On the top, bottom and right edges, there shall be not less than a fifteen millimeters (15 MM) margin; on the left edge, not less than fifty-one millimeters (51 MM) unless the marginal dimensions are specified otherwise by the NJDOT. Where practical, on large projects where the finished maps are numerous, the sheets shall be oriented on a block layout according to the format specified in Section 5-04.6a.

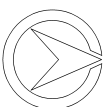

The NJDOT shall provide the information that is to appear in the title box of each sheet. In turn, the Contractor shall submit a sample sheet to the NJDOT for review containing all margin borders and title box data. The Contractor shall also submit an overall sheet layout of the entire Project for review showing the orientation and location of each final map prior to the commencement of work on the final map sheets.

#### 5-04.8 Index Maps

An index map shall be prepared to show the position and orientation of each map sheet in the Project with respect to all other map sheets. All map sheets shall be diagrammatically represented by the Contractor on one index sheet at the scale specified by the NJDOT.

The index map shall show all main roadways, coordinate grid lines, and sufficient information to permit a visual recognition of the location and orientation of the entire Project with respect to the surrounding terrain. Data shall also be adequate thereon to permit the selection of individual sheets.

The index map shall be rendered on plastic film as described in Section 5-03. It shall be reproducible by any of the standard printing processes so that lines and all other map detail and descriptive material will be neat, clear and legible.

On the top, bottom and right edges, there shall be not less than fifteen millimeters (15 MM) margin; on the left edge, not less than fifty-one millimeters (51 MM) unless the marginal dimensions are specified otherwise by the NJDOT.

### 5-05 MAP ACCURACY SPECIFICATIONS

#### 5-05.1 Horizontal Accuracies

- a. Planimetry: Ninety percent (90%) of all planimetric features which are well defined on the aerial photographs shall be plotted so that their positions on the completed map manuscripts shall be accurate to within at least sixty-four hundredths of a millimeter (0.64 MM) of their true positions, and none of the features shall be misplaced on the finished maps by more than one and three tenths of a millimeter (1.3 MM) from their true positions. Such true positions shall be ascertained by executing precise field surveys which originate and close on station markers established from the primary ground control survey(s).
- b. Grid Lines: The plotted position of each plane coordinate grid line shall not vary by more than three tenths of a millimeter (0.3 MM) from its true location on the corresponding map manuscript.
- c. Horizontal Control: Each horizontal control point shall be plotted within the plane coordinate grid in which it should lie to an accuracy of three tenths of a millimeter (0.3 MM) of its true position as pinpointed by the corresponding plane coordinates.

#### 5-05.2 Vertical Accuracies

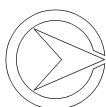



- a. Contours - Ninety percent (90%) of all elevations derived from solid line contours shall not deviate from true elevation by more than half a contour interval. The remaining ten percent (10%) shall be accurate to within a whole contour interval. In checking elevations taken from the contour map, the apparent vertical error may be decreased by assuming a horizontal displacement of sixty-four hundredths of a millimeter (0.64 MM).

In areas where the ground is obscured when consecutive aerial photographs are viewed stereoscopically through a photogrammetric instrument, contours shall be plotted as accurately as conditions permit. In places where the ground is visible, any photogrammetrically measured spot elevations shall be fully utilized in establishing such contours whenever possible. Contours generated under these conditions shall be represented by uniformly dashed lines.

- b. Spot Elevations - Ninety percent (90%) of all plotted spot elevations shall be accurately positioned to within one fourth a contour interval. The remaining ten percent (10%) shall be accurate to within half a contour interval.

### 5-05.3 Special Requirements

The NJDOT may require that all stipulated planimetric and topographic features be delineated and otherwise plotted on the maps, regardless of whether they can or cannot be seen on the aerial photographs when viewed through a photogrammetric instrument. In this case, the Contractor shall complete compilation of the required maps by executing ground field surveys and utilizing the notes therefrom in order to comply with the contract specifications.

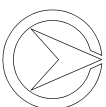

## SECTION 6

### DIGITAL TERRAIN MODELS

#### 6-01 GENERAL

Digital Terrain Model Specifications are for three-dimensional coordinates of points taken in a specified pattern and recorded on a computer-compatible media.

#### 6-02 TYPES OF DIGITAL TERRAIN MODELS

##### 6-02.1 Grid

Grid is a type of a digital terrain model which consist of elevations taken at regularly spaced intervals in two horizontal coordinate directions. These two horizontal directions should coincide with the northing and easting of the specified project coordinate system. Grids are advantageously used for measuring original and final terrain of borrow areas for quantity purposes.

##### 6-02.2 Cross-sections

Cross Sections are measured perpendicular to and at regular intervals and on low and high points along a centerline or baseline. Each cross section or baseline, measured for each significant break in the terrain. This type is used for defining the original terrain along the proposed line for the highway.

##### 6-02.3 Re-measurement

Re-measurement defines the terrain after earthwork is completed. Original measurement may have been in grid or cross-section pattern; re-measurement extends only as far as construction operations changed the terrain, and it includes measurement of the same grid points or along the same cross section lines, plus significant breaks in the surface as altered by construction.

##### 6-02.4 Critical Points

Critical Points define the topography of an area using three coordinate. From such data other descriptions of the topography can be derived, such as contours or cross sections along any chosen alignment.

#### 6-03 DESCRIPTION OF THE DIGITAL TERRAIN MODELS

##### 6-03.1 Type

The digital terrain model shall be grid, cross section, re-measurement or critical point type, whichever will be specified and applicable to the particular project. For grid digital terrain models, the maximum spacing shall be fifteen (15) meters, and likewise the

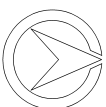

same maximum space for cross section, re-measurement or critical points. For cross sections the spacing shall be measured along the centerline or base line.

### 6-03.2 Area

NJDOT shall show on a map the area to be included in the digital terrain model by outlining it or by drawing a centerline or base line and specifying the width of coverage. A written description of the area in question may further define the area.

### 6-04 REQUIREMENTS FOR MAP COMPILATION BY THE USE OF DIGITAL PHOTOGRAMMETRIC METHOD

- All mapping must be compiled strictly in accordance with the requirements set forth in these specifications.
- All digital data shall be recorded directly as a function of stereoplotter operation. The operator should not read the stereoplotter settings and transfer them to the media. Post compilation digitizing or graphic compilation will not be permitted.
- The Contractor must submit the name and type of digital photogrammetric instrument to be utilized along with proof of the manufacturer's calibration which shall have been performed within the past two years.
- All digitally compiled mapping must be 100% clean and digitally edited by interactive editing equipment; "electronic manuscripts" will not be an acceptable delivery.
- Submittable hardware and software formats shall be verified with NJDOT and the client by the photogrammetrist on a project by project basis.
- All files shall be two-dimensional files. Coordinate values for all features shall be based on the grid system indicated by the control data.
- Files shall be compiled with coordinate values to the nearest millimeter (MM). If supplying INTERGRAPH design files to the NJDOT, the working units shall be as follows:

Master Units = meter (M)

Sub Units = millimeter (MM)

Resolutions = 10 positional units per millimeter (MM)

- To keep project files at manageable sizes, maximum file sizes shall be verified with NJDOT and the client by the photogrammetrist on a project by project basis and contain planimetric features for one or more entire stereo models. Individual stereo models shall not be separated into more than one file. Contours shall be in separate files corresponding in area to each planimetric file.
- In obscured areas where the photogrammetrically measured digital terrain model cannot be completed by this method, ground surveys shall be employed to complete the work.

### 6-05 ACCURACY

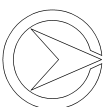

The Root-Mean-Square-Error (RMSE) which is defined as the square root of the quotient of the sum of the squares of the errors divided by the number of measurements, or

$$\text{RMSE} = [(\sum e^2)/n]^{1/2}$$

in which “e” is the error at each point (the difference between the value used as a standard and the value being tested) and “n” is the total number of points tested. The elevations, in meters, of all points tested shall not exceed the limit specified by NJDOT for the work. (Refer to Section 6-06 to discussions and procedures for the selection of RMSE limits). No individual error shall exceed three(3) times the specified limit for root-mean-square error. The average error (the algebraic sum of the individual test point errors, taking into consideration their signs, divided by the number of test points) shall not exceed three-tenths the specified limit for root-mean-square error.

The root-mean-square- error and the average error for any individual cross section or any individual group of grid points shall not exceed twice the limits established for the entire digital terrain model.

#### **6-06 SELECTION OF THE LIMITS FOR THE PROPER ROOT-MEAN-SQUARE-ERROR FOR DIGITAL TERRAIN MODEL**

The first consideration for a photogrammetrically produced digital terrain model is the relationship of the average depth of excavation and the needed accuracy. The average depth of excavation is the square meters of surface in the excavation areas divided by the number of cubic meters of materials to be excavated in the same areas. The root-mean-square-error for pay quantities should not exceed the average depth of excavation multiplied by the factor 0.03, but even in the heaviest excavation, the root-mean-square-error should not exceed 0.30 meters. If preliminary quantities only are being computed which will not be used for pay, the factor may be relaxed to 0.10 and the maximum to 0.45 meters. With the average depth of excavation estimated, this gives the root-mean-square-error to specify for ground surveyed digital terrain models and serves as a guide as to limits of usefulness of the photogrammetric method.

The second consideration for photogrammetrically produced digital terrain models is the capability of the stereoplotters. On open ground (no interfering cover) with uniform slopes, a double projection stereoplotter should be capable of producing elevations with a root-mean-square-error as small as 1/6 000 of the flight height; and an optical train stereoplotter, as small as 1/10 000 of the flight height. With irregular slopes, these reduce to about 1/5 000 and 1/8 000, and, with interfering ground cover, to about 1/3 000 and 1/5 000. This tells us that, considering the minimum flight height of 270 meters satisfactory pay quantities can be produced by a double projection instrument if the average depth of excavation is as small as  $(270/(6\ 000 \times 0.03)) = 1.5$  meters, and by an optical train stereoplotter if the average depth of cut is as small as  $(270/10\ 000 \times 0.03) = 0.90$  meter. For preliminary quantities for design, the minimum depth of excavation using a double projection stereo-plotter is as small as  $(270/6\ 000 \times 0.10) = 0.45$  meter, and using an optical trained stereoplotter, as small as  $(270/(10\ 000 \times 0.10)) = 0.27$  meter.

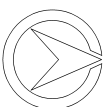

= 0.27 meter. Photogrammetric quantities are usually more accurate and less costly for moderate and heavier work, but for very light work, ground surveys are necessary.

Since average depth of cut is only an estimation when planning a photogrammetric mission, and flight height may be the quantity to define, a third consideration is the accuracy required for the use to be made of the quantities and types of terrain. Pay quantities where the slopes are uniform, i.e. flat to rolling terrain, require a root-mean-square-error of 0.06 meter or less, and where slopes are irregular, i.e. rugged terrain, require a root-mean-square error of 0.20 meter or less. For preliminary quantities, flat to rolling terrain with no interfering ground cover requires a root-mean-square-error of 0.20 meter or less, and rugged terrain with interfering cover requires 0.50 meter or less.

#### **6-07 ACCEPTANCE**

A digital terrain model for computing earthwork quantities for pay shall not be accepted until at least four (4) percent of the grid points or of the cross sections have been compared with ground surveyed data and have met specifications requirements. Grid points shall be in groups of 20 to 40 contiguous points. Cross sections shall be complete sections. No more than two (2) adjacent sections may be included at any location. These single sections, pairs of sections, or groups of points shall be distributed over the project area so as to be representative of the whole digital terrain model. A digital terrain model for computing preliminary earthwork quantities for design only may be accepted when the agency has made enough ground surveyed or stereoplotter tests to assure that the work meets all specification requirements.

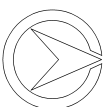

## SECTION 7

### MAP DETAILS

#### 7-01 ONE TO TWO THOUSAND SCALE, TWO METER CONTOURS

##### 7-01.1 Scale

The final scale shall be one to two thousand (1:2 000). There shall be differences of two meters (2.0 M) between intermediate contours and ten meters (10 M) between index contours.

##### 7-01.2 Map Manuscript Requirements

The final map manuscript sheets shall be prepared using a dimensionally stable, polyester-type plastic transparent film having a minimum thickness of one tenth of a millimeter (0.10 MM). Unless otherwise specified by the NJDOT, each sheet shall be not more than one & one half meters long by three fourth meter wide (1.5 M x 0.75 M) between the outside borders (Figure 7-1). Unless specified otherwise by the NJDOT, the gross width shall be uniform for each item or sub-item and thirty millimeters longer (15 millimeter margin on each end) than the net length of the longest sheet as indicated on the Item Map. The net width shall therefore be 675 millimeters. Match lines shall be provided so that each sheet may be joined accurately to those adjacent. The words "MATCH LINE TO SHEET NO. ??? OF ???" shall appear along the outside of each match line, and the title information shall appear in the lower margin.

##### 7-01.3 Contents

- a. General: Each map sheet shall show all the cultural features in accordance with the map scale standards under Table 5-1 where applicable to the 1:2 000 scale maps. It will be the Contractor's responsibility to show each required cultural feature in the position, orientation, shape and dimensions on the map sheet according to the following specifications:
  - (1) Buildings with one or more horizontal dimensions of 15 meters or more shall be drawn to scale. Buildings with one or more horizontal dimensions 7.5 to 15 meters shall be shown 7.5 M x 7.5 M. Buildings with one or more horizontal dimensions 4.5 to 7.5 meters shall be shown 4.5 M x 4.5 M. Buildings with no horizontal dimension greater than 4.5 meters need not be shown. The common walls of attached buildings of varying heights shall be shown.
  - (2) As an aid to orientation, all fence lines, walls and hedges which are identifiable as such on the aerial photography and which are not adjacent to highways, streets or trails, shall be shown as the physical limitations of the map sheet permit.
  - (3) Roads shall be shown with solid lines defining each pavement edge and spaced the distance between curbs, hard surface edges or travel path,

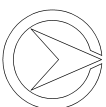

- as the case may be. Trails shall be indicated by a single, uniformly dashed line representing the centerline of each trail.
- (4) Power transmission or communication lines, which are constructed on private right-of-way and are cross country in nature, shall be shown. Where identifiable as such, towers and utility poles shall also be shown.
- b. Drainage: When so defined by the contour layout, drainage lines shall be shown by a dash-and-three-dot symbol in all drainage features when such features are at least four hundred meters (400 M) in length. All drainage lines shall be stopped at a distance of at least thirty meters (30 M) from the ridge lines. Streams averaging seven & one half meters (7.5 M) wide or more shall be represented with double lines in the form of dash-and-three-dot format, one line for each shore. The shorelines of small ponds shall also be represented by this symbol and the interiors of these ponds shall be shown lightly crosshatched. Large ponds, lakes, reservoirs and the like shall be lightly crosshatched twenty-five millimeters (25 MM) inside the shoreline. Where drainage is known to exist which would otherwise be indicated by depressed contours, any culverts or comparable drainage structures which can be identified as such on the aerial photographs, or are otherwise known to exist, shall be shown on the map.
- c. Relief: Datum shall be the North American Vertical Datum of 1988, and relief shall be shown by two meter (2 M) contour lines. Each fifth contour shall be accentuated and numbered with its corresponding elevation, an appropriate multiple of ten meters (10 M), above the Datum. Contour elevation numbers shall be shown along each accentuated contour line at intervals not to exceed a quarter of a meter (0.25 M). Elevations of all saddles, high and low spots, roadway intersections, railroad and roadway at-grade crossings, shall be shown to the nearest half of a meter (0.5 M). In depressions where drainage is indicated by structures, the contours shall not be shown as depressed contours.
- d. Coordinates: Grid lines shall be shown as continuous solid lines from inside border to inside border at 300 meter intervals. They shall conform to the criteria of the New Jersey State Plane Coordinate System and shall be labeled at the top, bottom and sides of each map sheet approximately twenty-five millimeters (25 MM) inward from the inside border. The plotted position of each New Jersey State Plane Coordinate grid line shall not vary from the true grid position by more than three tenths of a millimeter (0.3 MM) on each manuscript.

#### 7-01.4 Accuracies

- a. Cultural Features: Except for symbolized buildings, the plotted positions of ninety percent (90%) of the cultural features shown shall be within one & one half meters (1.5 M) of their actual corresponding position in the field as located with respect to the New Jersey State Plane Coordinate System and to the North American Vertical Datum of 1988. In no instance shall any error be greater than three meters (3.0 M).
- b. Contours: Ninety percent (90%) of all contour lines shall be correctly plotted to within half the contour interval ( $1.0 M_{\pm}$ ), and the remaining ten percent (10%) shall not be in error by more than a whole contour interval ( $2.0 M_{\pm}$ ) unless specified otherwise by the NJDOT. A contour which can be brought within

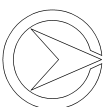

these tolerances by shifting its plotted position by sixty-four hundredths of a millimeter (0.64 MM) will be accepted as being correctly plotted.

- c. Spot Elevations: Ninety percent (90%) of all spot elevations shall be accurately plotted to within one fourth the contour interval ( $0.5 M_{\pm}$ ), and the remaining ten percent (10%) shall not be in error by more than one half the contour interval ( $1 M_{\pm}$ ).

## 7-02 ONE TO ONE THOUSAND SCALE, ONE METER CONTOURS

### 7-02.1 Scale

The final scale shall be one to one thousand (1:1 000). There shall be a difference of one meter (1 M) between intermediate contours and 5 meters (5 M) between index contours.

### 7-02.2 Map Manuscript Requirements

The final map manuscript sheets shall be prepared using a dimensionally stable, polyester-type plastic transparent film having a minimum thickness of one tenth of a millimeter (0.10 MM).

Unless specified otherwise by the NJDOT, each sheet shall not be more than one and one half meters long and three fourth meters wide (1.5 M x 0.75 M). Between the outside borders, the gross width shall be uniform for all sheets, and the gross length shall be uniform for each thirty millimeters larger (15 MM margin on each end) than the net length of the largest sheet as indicated on the Item Map. The net width shall therefore be 675 millimeters. Match lines shall be provided so that each sheet may be joined accurately to those adjacent. The words "MATCH LINE TO SHEET NO. ??? OF ???" shall appear along the outside of each match line, and the title information shall appear in the lower margin. See Figure 7-1 for an example.

- a. General: Each map sheet shall show all the cultural features in accordance with Table 5-1 where applicable to the 1:1 000 scale maps. It will be the Contractor's responsibility to show each required cultural feature in the position, orientation, shape and dimensions on the map sheet according to the following specifications:
- (1) Buildings with one or more horizontal dimensions of 6 meters or more shall be drawn to scale. Smaller buildings with one or more horizontal dimensions between 3 to 6 meters shall be shown 3 M x 3 M. Buildings with no horizontal dimensions greater than 3 meters need not be shown. The common walls of attached buildings of varying heights shall be shown.
  - (2) As an aid to orientation, all fence lines, walls and hedges which are identifiable as such on aerial photographs and which are not adjacent to highways, streets or trails, shall be shown as the physical limitations of the map sheet permit.

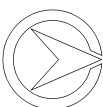



- (3) Regularly aligned roads shall be plotted using straightedge and uniformly curved drawing templates, and the rendering of such drawings shall be executed with special care. Freehand or irregular-curve drawing shall be permitted only on meandering trails or roads of irregular alignment.
  - (4) Power transmission and communication lines, which are constructed on private right-of-way and are cross country in character, shall be shown. Where identifiable as such, towers and utility poles shall also be shown.
- b. Drainage: When so defined by the contour layout, drainage lines shall be shown by a dash-and-three-dot symbol in all drainage features when such features are at least 400 meters in length. All drainage lines shall be stopped at a distance of at least fifteen meters (15 M) from the ridge lines. Streams averaging three meters (3 M) or more wide shall be represented with double lines in the dash-and-three-dot format, one line for each shore. The shoreline of small ponds shall also be shown lightly crosshatched. Large ponds, lakes, reservoirs and the like shall be lightly crosshatched twenty-five millimeters (25 MM) inside the shore line. Where drainage is known to exist which would otherwise be indicated by depressed contours, any culverts or other comparable drainage structures which can be identified as such on the aerial photographs, or are otherwise known to exist, shall be shown on the map.
  - c. Wooded Areas: Woodland outlines shall be carefully and accurately delineated. A cleared band of actual width shall be shown along all transmission and communication lines. Woodland outlines must be positioned exactly, especially where the boundary is a road, railroad, transmission or major communication line right-of-way.
  - d. Relief: Datum shall be the North American Vertical Datum of 1988 and relief shall be shown by one meter (1 M) contour lines. Each fifth contour line shall be accentuated and numbered with its corresponding elevation, an appropriate multiple of five meters (5 M), above the Datum. Contour elevation numbers shall be shown along the accentuated contour line at intervals not to exceed a quarter of a meter (0.25 M). Elevations of all saddles, high and low spots, roadway intersections, railroad and roadway at-grade crossings, shall be shown to the nearest tenth of a meter (0.1 M). In depressions where drainage is indicated by structure, the contours shall not be shown as depressed contours.
  - e. Coordinates: Grid lines shall be shown as continuous solid lines from inside border to inside border at 150-meter intervals. They shall conform to the criteria of the New Jersey State Plane Coordinate System and shall be labeled at the top, bottom and sides of each map sheet approximately twenty-five millimeters (25 MM) inward from the inside border.

The plotted position of each New Jersey State Plane Coordinate grid line shall not vary from the true grid position by more than three tenths of a millimeter (0.3 MM) on each manuscript.

### 7-02.3 Accuracies

- a. Cultural Features: Except for symbolized buildings, the plotted positions of ninety percent (90%) of the cultural features shown shall be within 0.75 meters

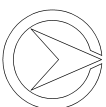

of their actual corresponding positions in the field as located with respect to the New Jersey State Plane Coordinate System and to the North American Vertical Datum of 1988. In no instance shall any error be greater than one & one half meters (1.5 M).

- b. Contours: Ninety percent (90%) of all contour lines shall be correctly plotted to within half the contour interval ( $0.5 M_{\pm}$ ), and the remaining ten percent (10%) shall not be in error by more than a whole contour interval ( $1.0 M_{\pm}$ ) unless specified otherwise by the NJDOT. A contour which can be brought within these tolerances by shifting its plotted position by sixty-four hundredths of a millimeter (0.64 MM) will be accepted as being correctly plotted.
- c. Spot Elevations: Ninety percent (90%) of all spot elevations shall be accurately plotted to within one fourth the contour interval (0.25 meters) and the remaining ten percent (10%) shall not be in error by more than half the contour interval (0.50 meters).

## 7-03 ONE TO FIVE HUNDRED SCALE, HALF METER CONTOURS AND ONE TO THREE HUNDRED SCALE, HALF METER CONTOURS

### 7-03.1 Scale

The final scale shall be either one to five hundred (1:500) or one to three hundred (1:300) as specified by the NJDOT. Although references throughout Section 7-03 will be made with respect to the 1:500 scale, said references shall be construed to apply to the 1:300 scale as well.

### 7-03.2 Map Manuscript Requirements

The final map manuscript sheets shall be prepared using a dimensionally stable, polyester-type plastic transparent film having a minimum thickness of one tenth of a millimeter (0.10 MM). Unless specified otherwise by the NJDOT, each sheet shall be not more than one & one half meters long and one meter wide (1.5 M x 1.0 M) between the outside borders. The gross width shall be uniform for all sheets while the gross length shall be uniform for each item or sub-item; all map manuscripts shall be identical in size and material in accordance with these Specifications.

Match lines shall be provided so that each sheet may be joined accurately to those adjacent, and the words "MATCH LINE TO SHEET NO. ??? of ???" shall appear along the outside of each match line.

A fifteen millimeter (15 MM) margin shall be provided on the upper, lower and left edges while the right edge shall have sufficient width to allow the incorporation of the Project's title information (see Figures 7-3, 7-4, and 7-5). The roll number, sheet number and the project number shall appear in the upper left-hand corner.

The Contractor shall be required to complete two types of maps of the same project area to fulfill the 1:500 scale with 0.5 meter contour mapping requirements unless stipulated otherwise by the NJDOT:

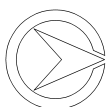

1:500 SCALE PLANIMETRIC MAP  
1:500 SCALE TOPOGRAPHIC MAP

When so ordered by the NJDOT, the final sheets to be incorporated into an official set of Contract Plans shall be not more than eight hundred -forty one millimeters long and five hundred ninety-four millimeters wide (841 MM x 594 MM) between the outside edges. The title block shall appear in the lower right-hand corner. Each plan sheet shall be identical in size and material and shall be prepared in accordance with the SAMPLE PLAN SHEETS guidelines adopted by the NJDOT.

- a. **General:** Each map sheet shall show all the cultural features in accordance with Table 5-1 where applicable to the 1:500 scale maps. It will be the Contractor's responsibility to show each required cultural feature in the position, orientation, shape and dimensions on the map sheet according to the following specifications:
- (1) All structures with one or more horizontal dimensions of one and one half meters 1.5 M or more shall be drawn to scale and represented by the outlines of their foundations. Such appurtenances as porches and steps shall be shown. The common walls of attached buildings of varying heights shall be shown. Structures of a temporary nature, such as picnic tables and construction sheds, shall not be shown.
  - (2) All fence lines, walls, hedges, curbs, utility poles, and outstanding trees with crown diameters greater than three meters (3.0 M) (except in wooded areas) that are identifiable as such on aerial photographs, shall be shown.
  - (3) Regularly aligned roads shall be plotted using straightedge and uniformly curved drawing templates, and the rendering of such drawings shall be executed with special care. Freehand or irregular-curve drawing shall be permitted only on meandering trails or roads of irregular alignment.
  - (4) All roads, walks, drives, railroad tracks and trails shall be shown to scale. Curbed roadways shall have each pavement edge represented with solid double lines wherever there is curb.
  - (5) Paved roadways without curb or designated shoulder areas shall be represented with single solid lines defining each pavement edge. Uncurbed roadways with designated shoulders shall be represented with uniformly dashed lines denoting the pavement edge wherever shoulder pavement is encountered. Trails shall be indicated by a single, uniformly dashed line denoting the travel path.
  - (6) All power transmission and communication lines shall be shown to scale, together with their accompanying utility poles and tower bases where encountered.
- b. **Drainage:** When so defined by the contour layout, drainage lines shall be shown by a dash-and-three-dot symbol in all drainage features when such features are at least four hundred meters (400 M) in length. All drainage lines shall be stopped at a distance of at least fifteen meters (15 M) from the ridge lines. Streams averaging one & one half (1.5 M) or more wide shall be

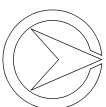

represented with double lines in the dash-and-three-dot format, one line for each shore. The shorelines of small ponds shall also be represented by this symbol, and the interiors of these ponds shall be shown lightly crosshatched. Large ponds, lakes, reservoirs and the like shall be lightly crosshatched twenty-five millimeters (25 MM) inside the shoreline. Where drainage is known to exist which would otherwise be indicated by depressed contours, any culverts or other comparable drainage structures which can be identified as such on the aerial photographs, or are otherwise known to exist, shall be shown on the map.

- c. Wooded Areas: Woodland outlines shall be carefully and accurately delineated. A cleared band of actual width shall be shown along all transmission and communication lines. Woodland outlines must be positioned exactly, especially where the boundary is a road, railroad, transmission or communication line right-of-way. Freestanding trees with crown diameters of three meters (3 M) or greater shall also be shown.
- d. Relief: Datum shall be the North American Vertical Datum of 1988 and relief shall be shown by one half meter (0.5 M) contour lines. Each fourth contour shall be accentuated and numbered with its corresponding elevation, an appropriate multiple of two meters (2 M), above elevation numbers shall be shown along the contour line at intervals not to exceed quarter of a meter (0.25 M).

Elevations of all saddles, high and low spots, roadway intersections, railroad and roadway at-grade crossings, shall be shown to the nearest one-hundredth of a meter (0.01 M $\pm$ ). In depressions where drainage is indicated by structure, the contours shall not be shown as depressed contours. Where elevations are interpolated because the ground is obscured in the aerial photographs, the corresponding contours shall be represented by uniformly dashed lines.

- e. Coordinates: Grid lines shall be represented as continuous solid lines from inside border to inside border at 75-meter intervals for a 1:500 plan and 45-meter intervals for a 1:300. They shall conform to the criteria of the New Jersey State Plane Coordinate System and shall be labeled at the bottom and sides of each map sheet approximately twenty-five millimeters (25 MM) inward from the inside border. The plotted position of each New Jersey State Plane Coordinate grid line shall not vary from the true grid position by more than three tenths of a millimeter (0.3 MM  $\pm$ ) on each manuscript.

### 7-03.3 Accuracies

- a. Cultural Features: Except for symbolized buildings, the plotted positions of ninety percent (90%) of the cultural features shown shall be within three tenths of a meter (0.3 M) of their actual corresponding positions in the field as located with respect to the New Jersey State Plane Coordinate System and to the North American Vertical Datum of 1988. In no instance shall any error be greater than six tenths of a meter (0.6 M $\pm$ ).
- b. Contours: Ninety percent (90%) of all contour lines shall be correctly plotted to within half the contour interval (0.25 M), and the remaining ten percent (10%) shall not be in error by more than a whole contour interval (0.50 M) unless

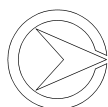

specified otherwise by the NJDOT. A contour which can be brought within these tolerances by shifting its plotted position by sixty-four hundredths of a meter (0.64 M) will be accepted as being correctly plotted.

- c. **Spot Elevations:** Ninety percent (90%) of all spot elevations shall be accurately plotted to within one fourth the contour interval (0.125 M) and the remaining ten percent (10%) shall not be in error by more than one half the contour interval (0.25 M). As stipulated by the NJDOT, spot elevations may be required at the following locations:

- (1) At 15 meter intervals along the centerlines of roadways and medians where they exist.
- (2) At 15 meter intervals along the edges of roadway pavements and paved shoulders or gutter lines.
- (3) In between contour lines that are more than 15 meters apart horizontally.
- (4) On the grates of inlets and catch basins and on other drainage structures.
- (5) At the bottom and top of curbs on grade-separated roadway structures.
- (6) At other locations when so directed.

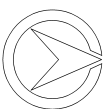

## 7-04 STANDARD ACCURACIES FOR PHOTOGRAMMETRIC MAPPING

Standard accuracies for photogrammetric mapping are listed in Table 7-1.

**Table 7-1: Standard Accuracies for Photogrammetric Mapping**

SCALE	CONTOUR INTERVALS	CULTURAL FEATURES	CONTOURS*	SPOT ELEVATIONS	MAX. SHEET SIZE
1:2 000	two meters accentuate 10 meters contour	90% shall be within 1.5 M of the actual position; 10% shall not exceed 3.0 M of actual position.	90% shall not exceed 1.0 M of the actual elevation; 10% shall not exceed 2.0 M of the actual elevation.	90% shall not exceed 0.5 M of the actual elevation; 10% shall not exceed 1.0 M of actual elevation.	1.5 M long and 0.75 M wide.
1:1 000	one meter accentuate 5 meters contour	90% shall be within 0.75 M of the actual position; 10% shall not exceed 1.5 M of the actual position.	90% shall not exceed 0.5 M of the actual elevation; 10% shall not exceed 1.0 M of the actual elevation.	90% shall not exceed 0.25 of the actual elevation; 10% shall not exceed 0.5 M of the actual elevation.	1.5 M long and 0.75 M wide
1:500 and 1:300	one-half meters (1:500) and one-fourth meters (1:300) accentuate every fourth.	90% shall be within 0.3 M of the actual position; 10% shall not exceed 0.6 M of the actual position.	90% shall not exceed 0.25 M of the actual elevation; 10% shall not exceed 0.50 M of the actual elevation.	90% shall not exceed 0.12 M of the actual elevation; 10% shall not exceed 0.25 M of the actual elevation.	1.5 M long and 1.0 M wide.
As determined	As determined	90% shall be within; 10% shall not exceed of the map scale actual position.	90% shall not exceed one half of the contour interval of the actual elevation; 10% shall not exceed one contour interval of the actual elevation.	90% shall not exceed one quarter of the contour interval of the actual elevation; 10% shall not exceed one half of the contour interval of the actual elevation.	As determined
<p><b>*Note:</b> Contours may be shifted by sixty-four hundredths of a millimeter (0.64 MM) in order to achieve the vertical requirements.</p>					

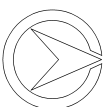
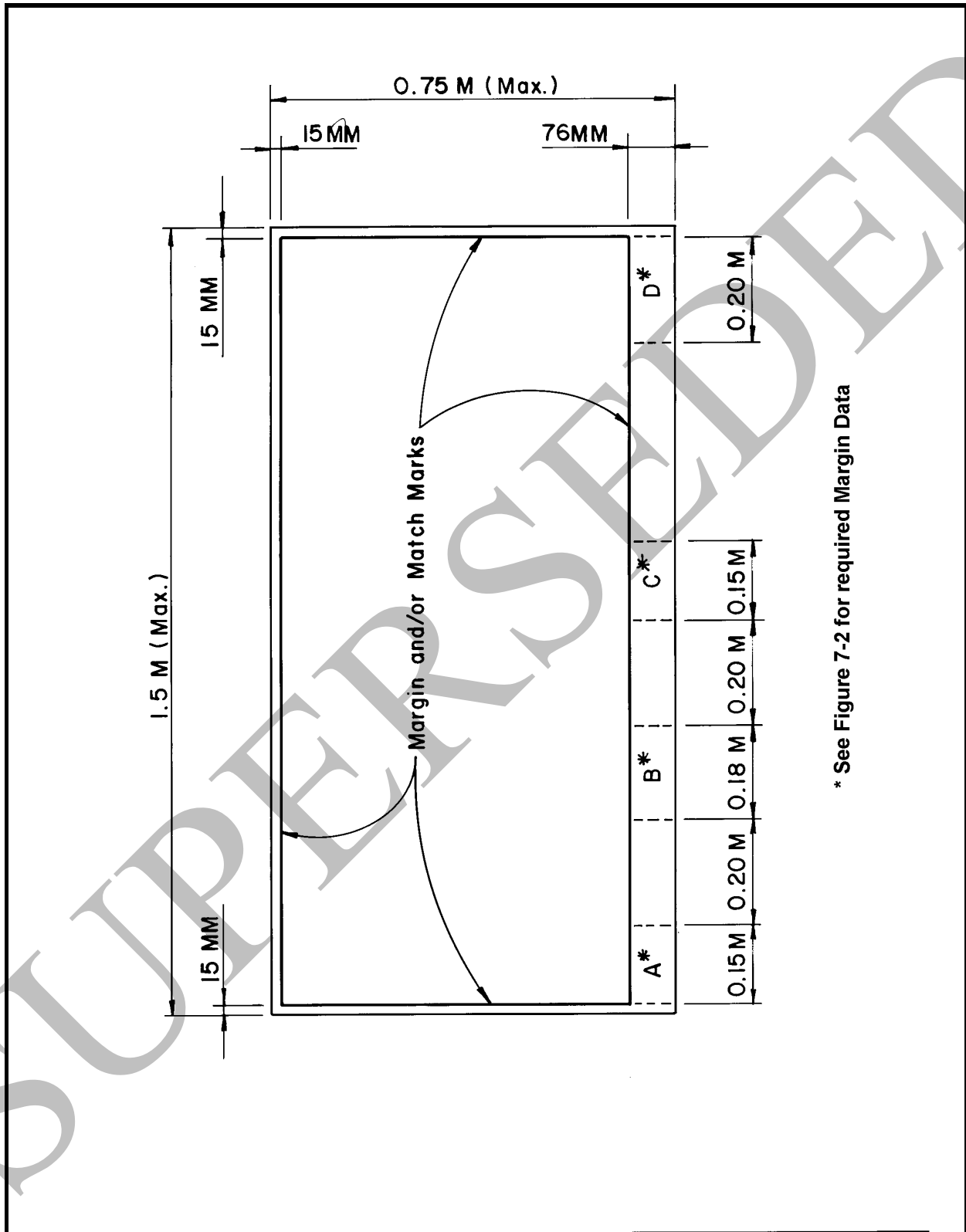

FIGURE 7-1: TYPICAL MANUSCRIPT SHEET LAYOUT 1:1 000 SCALE AND 1:2 000 SCALE MAPPING



\* See Figure 7-2 for required Margin Data

FIGURE 7-2: SAMPLE MARGIN DATA 1:1 000 SCALE AND 1:2 000 SCALE MAPPING

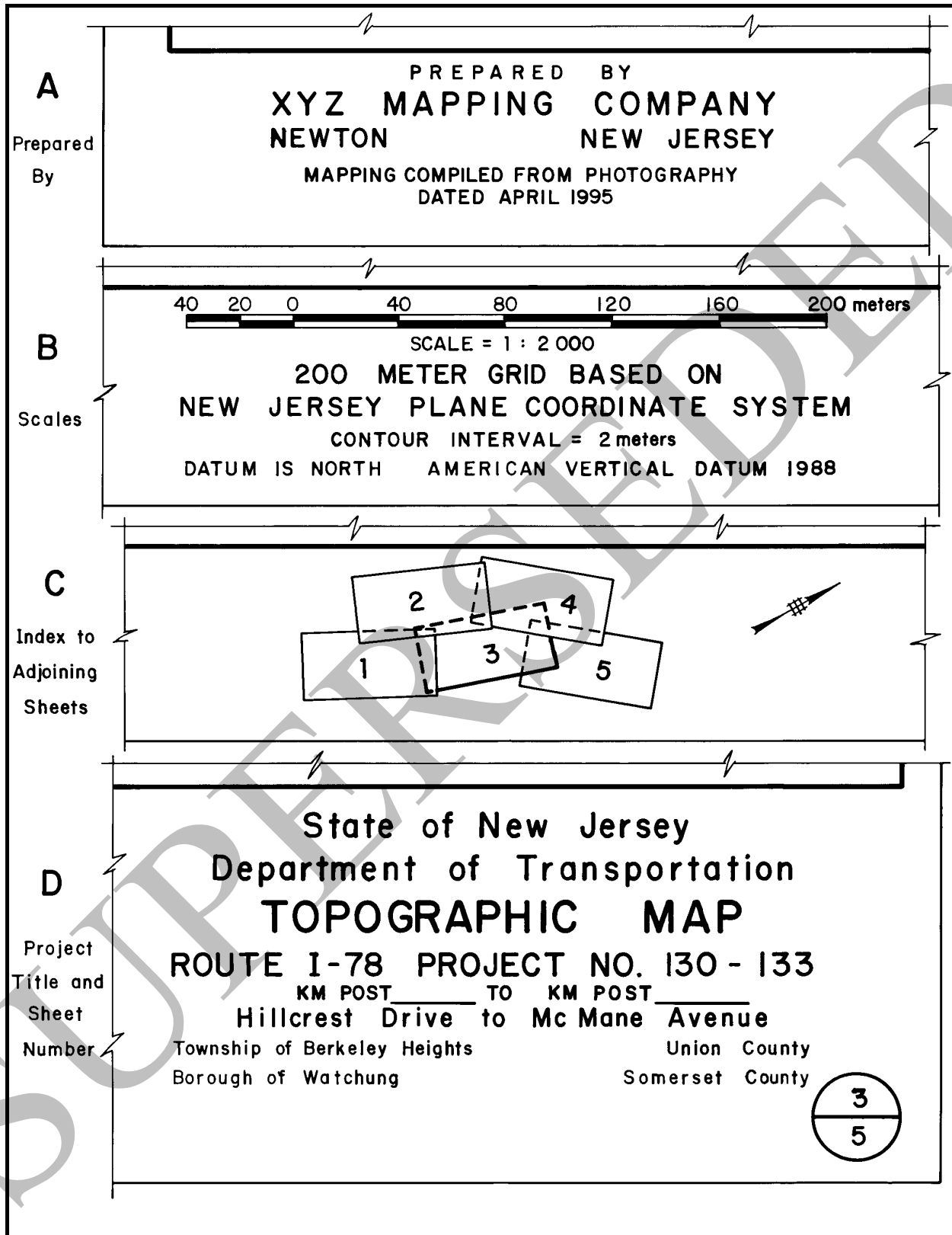



FIGURE 7-3: TYPICAL MANUSCRIPT SHEET LAYOUT 1:500 SCALE AND 1:300 SCALE MAPPING

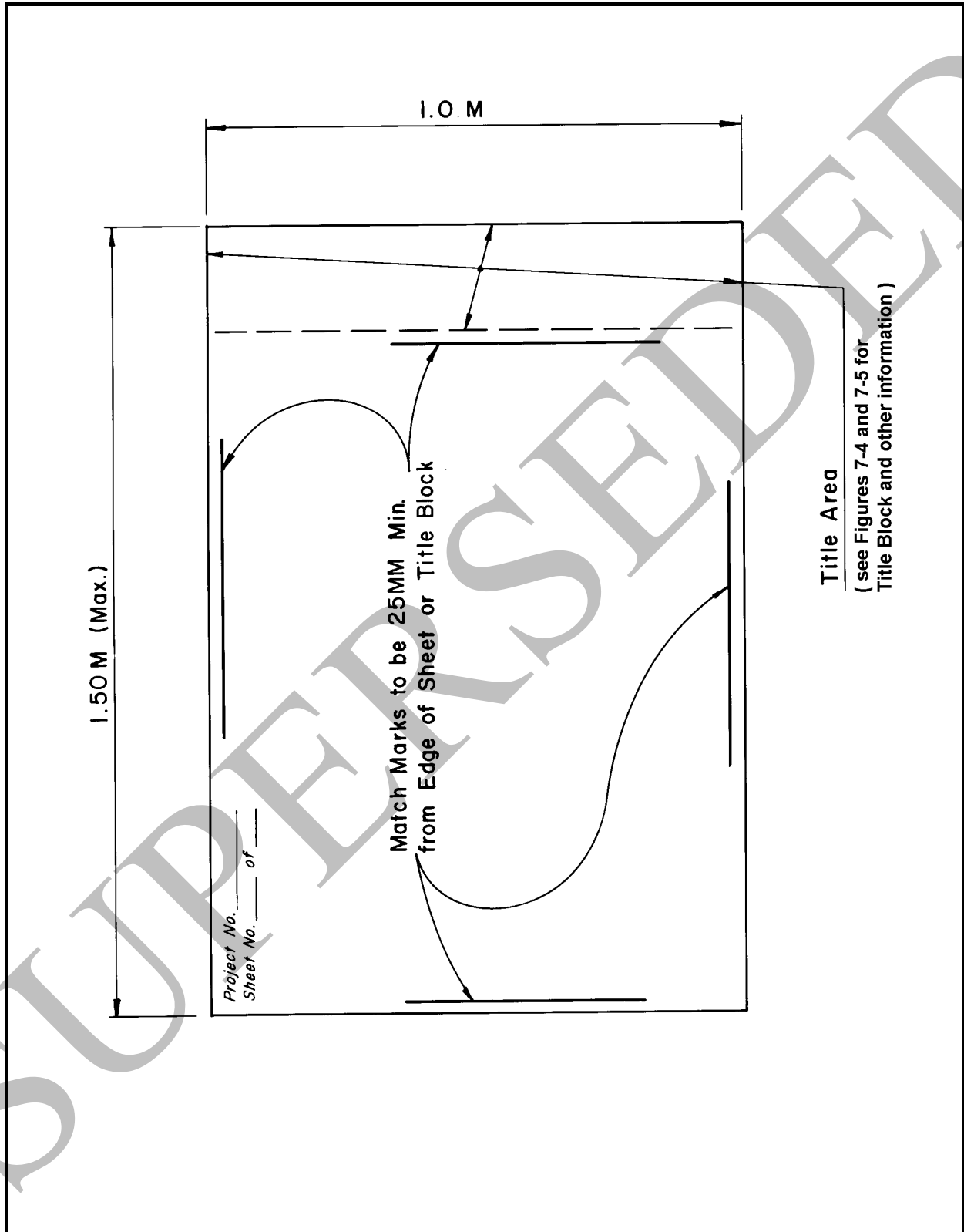

FIGURE 7-4: SAMPLE TITLE FOR 1:300 SCALE TOPOGRAPHIC MAP

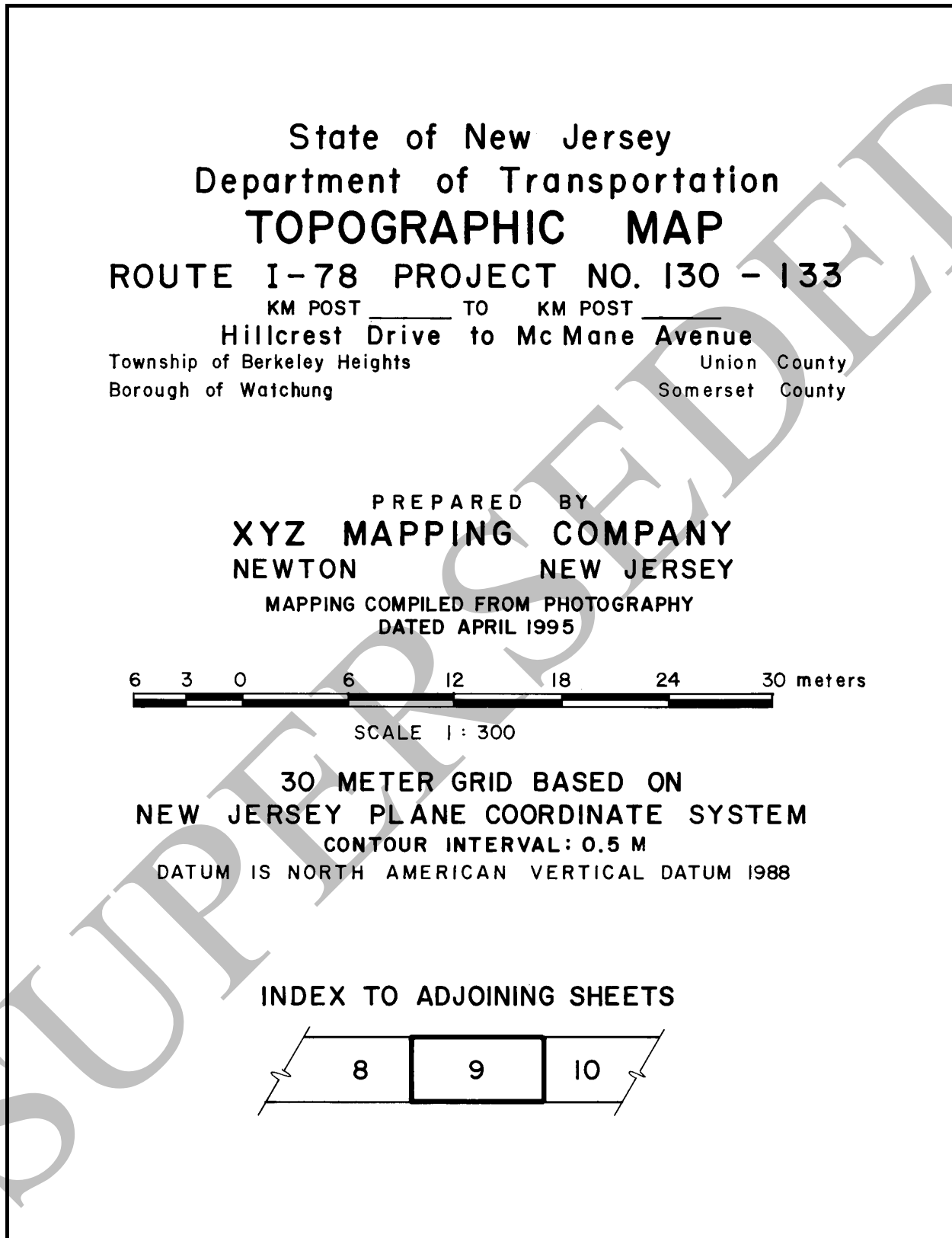
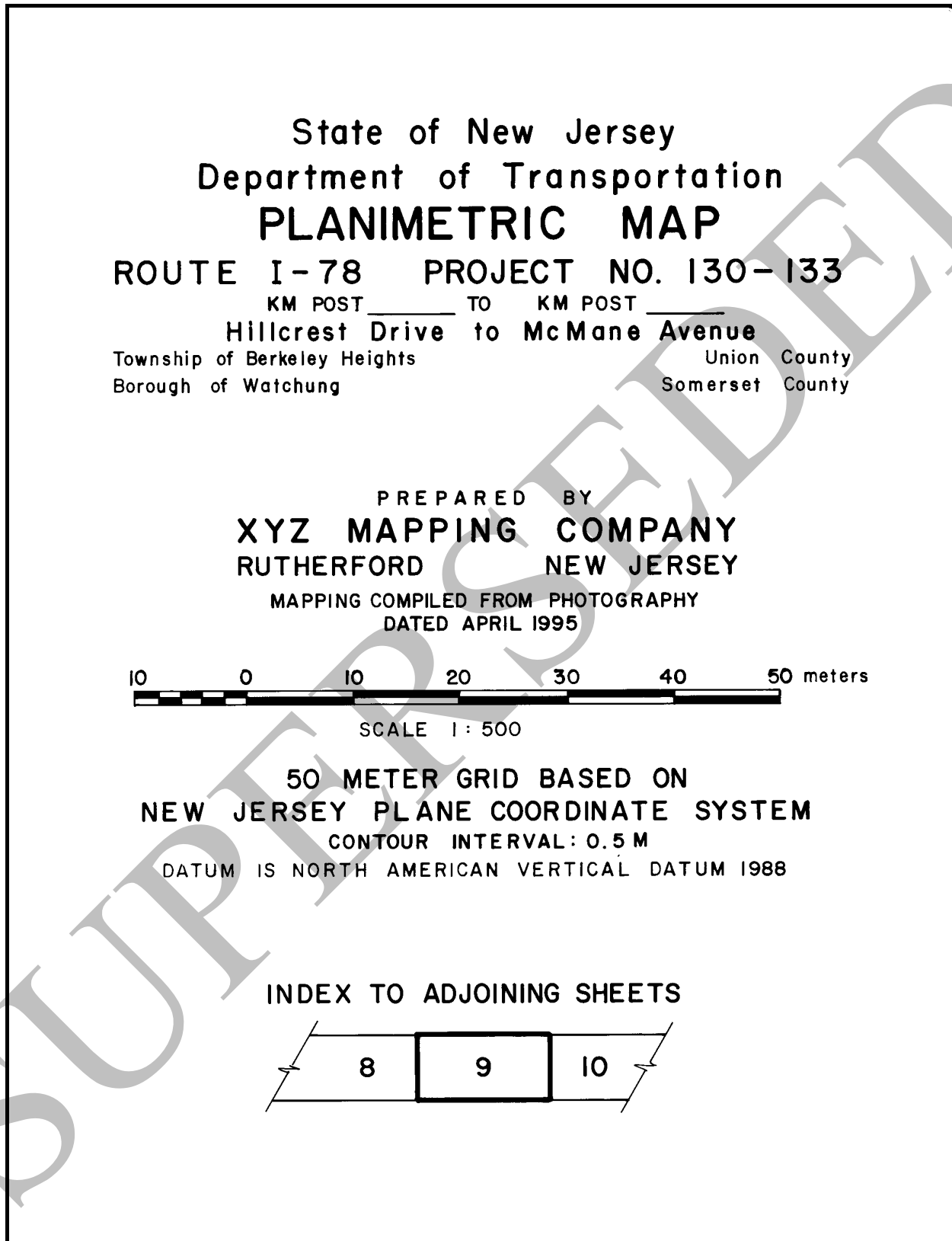

FIGURE 7-5: SAMPLE TITLE FOR 1:500 SCALE PLANIMETRIC MAP



## SECTION 8

### DELIVERY AND PAYMENT

#### 8-01 MATERIALS TO BE DELIVERED

- Two complete sets of 230 MM x 230 MM contact photographs providing full stereoscopic coverage of the project area.
- Two 510 MM x 610 MM photographic index maps.
- Two sets of all field notes, computation and adjustment sheets, monument and other control description sheets for all field surveys completed on the project including a control map, in hard and NJDOT compatible computer format.
- One complete set of annotated contact prints showing all analytically generated supplemental control used on the project.
- If so employed by the Contractor, one bound copy of all computer printout sheets showing the analytical aerotriangulation supplemental control values and specifying the final control results in terms of root mean square errors.
- One complete set of maps and/or Contract plan sheets, as stipulated and at the scale (s) specified by the NJDOT, on tracing sheets made of dimensionally stable polyester-type plastic transparent film having a minimum thickness of one tenth of a millimeter (0.10 MM).
- One or more overall index sheets showing all map and/or Contract plan sheets covering the entire project on plastic film as specified in (6) above.

#### 8-02 PERFORMANCE SCHEDULE

Using whatever guidelines are provided elsewhere within these Specification, the NJDOT and the Contractor shall develop a mutually agreed-upon schedule for the satisfactory completion and delivery of all work, products and services ordered by the NJDOT. This schedule shall be consistent with sound photogrammetric production concepts and procedures and with the NJDOT's need for the mapping.

#### 8-03 BASIS FOR PAYMENT

- Payment shall consist of full compensation for all work completed and accepted by the NJDOT, for defrayal of all fees and other costs, for performance of extra work and alterations ordered by the NJDOT, and for submission and delivery to the NJDOT according to the Proposal, the Contract and any subsequent Addenda and Change Orders.
- Using whatever guidelines are provided elsewhere within these Specifications, the Contractor and the NJDOT shall mutually agree on the terms by which progress payments and the final payment shall be made for the completed work.

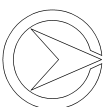

## SECTION 9

### GLOSSARY

Acceptance: The formal written acceptance by the Commissioner of Transportation of an entire Contract which has been completed in all respects in accordance with the Contract documents.

Accuracy: The degree of agreement between a measured value and the true value.

Aerial Negative: The original photo image produced by aerial photography onto reproducible film and used to produce prints and/or positive photographs.

Aerial Photograph, Oblique: Photographs taken at any angle below the horizon short of ninety degrees and used primarily for environmental analyses and outside presentations.

Aerial Photograph, Vertical: An aerial photograph with the camera's longitudinal axis as close to truly vertical (90° below horizontal plane) as possible.

Aerotriangulation: The establishment of supplemental control points by precisely marking their locations onto glass photographic diapositives. Spatial solutions are then obtained by precise measurements and computational routines.

Air Base: The line, or length of line, joining two adjacent camera stations.

Altitude: The vertical distance above the reference elevation or datum, usually the National Geodetic Vertical Datum of 1929, or the North American Vertical Datum of 1988, of an object or point in space.

Analytics: The densification of horizontal and vertical control using measurements made on aerial photographs through aerotriangulation methods.

Antivignetting Filter: A filter used with wide-angle photography to produce uniform lighting over the whole photograph.

Attitude: The angular orientation of a camera with respect to some external reference system.

Azimuth Line: A radial line from the Principal Point of a photograph to a similar point in an adjacent photograph in the same flight line.

Basic Control: A system of horizontally and/or vertically established and monumented control points over the entire roadway project. Such points are established at a one to two kilometer spacing to serve as closure points for all other project surveys.

Bench Mark: A monument point of known elevation.

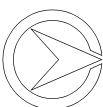

Cadastral: Pertaining to the extent, value and ownership of land. Cadastral maps show property corners and property lines.

Camera Axis: A line through the camera's rear nodal point which is perpendicular to the film plane.

Camera Station: The point in space where the forward node of the camera lens was located at the instant the exposure was made.

C-factor: (also called Contouring Factor) The ratio of the flight height to the smallest contour interval which a photogrammetric system can consistently compile on a map manuscript to the required accuracy.

Comparator: A precise instrument which measures two dimensional plane coordinates from a vertical aerial photograph.

Compilation: The production of a map or base plan from aerial photographs and geodetic control data using photogrammetric instruments and techniques.

Contact: A method of printing in which an original translucent photograph or drawing is placed in contact with photosensitive material and exposed, thereby producing an exact image of the original onto the material.

Contract: The legally binding agreement between the NJDOT and the Contractor setting forth the obligations of the parties thereunder, including but not limited to, the performance of the work, the furnishing of labor and materials, and the basis of payment. The Contract represents the entire and integrated agreement between the parties and supersedes all prior negotiations, representations or agreements, either written or oral.

Contractor: The individual, partnership, firm, corporation, or any acceptable combination thereof, contracting with the NJDOT for performance of prescribed work.

Contour: A theoretical line tangent to the earth's surface at a known elevation. Also, a line "locating" this elevation on a map or plan.

Contrast: The degree of difference between the lightest and darkest areas of a photograph.

Control: A system of horizontally and/or vertically established monumented points used to reference map features. There are four classifications of precision (the first order being the highest) depending upon the overall precision and quality of the methods and instruments utilized.

Control, Ground: Control brought about by conventional field survey methods as opposed to aerial survey methods. This control is used to complement photogrammetry work and to compensate for any deficiencies resulting from the latter.

Control, Horizontal Ground: This control positions and identifies ground points by survey ties or plane coordinates.

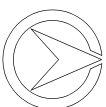

Control, Vertical Ground: This control positions points vertically relative to a reference datum such as the National Geodetic Vertical Datum of 1929 or the North American Vertical Datum of 1988.

Control Point: On a photograph, any identified station or reference point used in fixing the attitudes and/or positions of one or more related photographs.

Coordinates: A set of “cell” numbers or “addresses” used to define the positions of points on a photograph or plan sheet with respect to a reference grid system. In photogrammetry, the coordinate axes are usually either the fiducial axes, or the principal line and the photograph parallel. If a three dimensional system is used, the origin is either the principal point or the perspective center.

Cover: In mapping, vegetation over a terrain.

Crab: The condition caused by failure to correctly position the camera with respect to the airplane’s line of flight. This results in the angular displacement of the photographic axis relative to the flight line.

Culture: In mapping, man-made features.

Deformation: A change in the position of a point on a photograph, map, manuscript or print from its originally plotted position. This change is the result of differential shrinkage and/or expansion of the film or paper.

Develop: To process exposed photographic material and thereby reveal the latent image contained thereon.

Diapositive: A positive photographic transparency, usually glass, designed for use in a precision photogrammetric instrument.

Displacement: Any shift in the position of a point, line or feature on a photograph.

Displacement Due to Relief: An unavoidable characteristic of aerial photography in which high and low elevation points appear further from and closer to the center of aerial photographs, respectively, than their actual positions indicate.

Distortion: A change in the position of a point on a photograph from its original position caused by an aberration or combination of aberrations in the camera lens.

Dodging: The selective shading or masking of a portion of a photograph during copying to soften the contrast. Automatic dodging selectively varies the illumination over the photograph in proportion to the average density of each area on the photograph.

Electronic Distance Measuring Instrument or Device (EDMI): An instrument which transmits and receives a modulated electromagnetic signal and translates the raw data into a readout of distance between the instrument and the reflector or retransmitter. The readout is

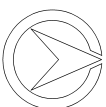

automatically derived from the monitoring and compiling of phase differences between the modulations of transmitted and reflected or retransmitted signals.

Elevation: Is the vertical distance above or below an arbitrarily assumed level surface of curved surface every element of which is normal to the plumb line. The level surface used for reference is called datum. The datum in this case is the North American Vertical Datum of 1988 (NAVD 88).

Fiducial Marks: Indicators produced in the middle of each border and/or in each corner of the negative at the moment of exposure and used to locate the photograph's principal point.

Flight Altitude: The average vertical distance between the aerial camera and the ground.

Flight Line or Flight Strip: (1) The flight path of the airplane carrying the camera. (2) The strip of photographs produced from a single flight.

Flight Plan: The aerial photography operational procedure in which the flight objectives and the performance criteria are specified.

Focal Length: The distance from the plane of infinite focus to the center of the camera lens.

Geodetic Survey: A survey which takes into account the curvature of the earth's surface.

Geoid: An equipotential surface (a surface of equal gravity) coincident with the National Geodetic Vertical Datum of 1929 or the North American Vertical Datum of 1988.

Grid: A uniform system of equally spaced perpendicular and parallel lines superimposed onto aerial photographs, mosaics, maps, plan sheets and other representations of the earth's surface and used to identify the positions of points.

Inertial Surveying: A system that used accelerometers, gyroscopes and a computer to sense the earth's rotation and to orient itself with respect to north-south and east-west alignments as well as to the direction of gravity as it is moved from point to point.

Interpretation: The result of a stereoscopic examination of aerial photographs, augmented by data and imagery from other sources, to obtain qualitative information about the terrain, cover and culture which may influence the location of a proposed highway.

Manuscript or Base Map: The original master reproducible sheet upon which the data gathered from the aerial photographs has been compiled.

Map, Index: (1) A small-scale map showing the position and orientation of each map or contract plan sheet with respect to all the other map or contract plan sheets in a given project. (2) A map showing the locations and numbers of flight strips and photographs. (3) A small-scale map showing geodetic control and such data comparable to that found on larger-scale topographic quadrangle maps.

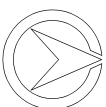



Map, Photogrammetric: An orthographically projected rendering of existing land features produced with a stereoplotting instrument.

Map, Planimetric: A reproducible copy of the manuscript showing the shape and horizontal position of natural and man-made (cultural) features with no regard for elevation or measurable relief.

Map, Topographic: A reproducible copy of the manuscript showing the shape and the horizontal and vertical position of natural and man-made features. Elevations and measurable ground relief are usually delineated by contours and by spot elevations at prominent locations.

Micron: (also known as Micrometer). A unit of length equal to one thousandth of a millimeter (0.001 MM).

Model: The stereoscopic image of an area produced by viewing the end lapping of two successive aerial photographs depicting the same ground area from two different positions of exposure and culminating in a three dimensional image when observed through a binocular viewer.

Mosaic: A large sequential composite of individual photographs showing a continuous overview of a project site from beginning to end.

Mosaic, Controlled: Wherein each photograph was sealed and rectified relative to horizontal ground control and matched to adjacent photographs as closely as possible.

National Geodetic Vertical Datum of 1929: The average of the heights of the sea surface at all stages of tide. In photogrammetry, the National Geodetic Vertical Datum of 1929 is also referred to as Mean Sea Level.

Nadir Point: (1) Photographic: where a vertical line originating from the central point of exposure in the camera intersects the plan of the photograph. The photographic nadir point coincides with the principal point of the photograph when that photograph is truly vertical. (2) Ground: where that vertical line intersects the ground surface. (3) Datum: where that vertical line intersects the reference datum surface.

Neat Model: The stereoscopic area between adjacent principal points along the flight line (breadth) and extending out sideways to the middle of the side laps (width). The neat model represents the approximate mapping area of each pair of overlapping aerial photographs, (width) x (breadth).

NJDOT: State of New Jersey, Department of Transportation.

North American Vertical Datum of 1988: A datum formed by using an ellipsoidal approximation of the planet surface, recalculated in 1988.

Nodal Points: A camera lens has two such points: an incidental (frontal) point and an emergent (rear) point. These points lie on the optical axis of the lens and have the property

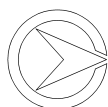

that any light ray directed toward the incident point passes through the emergent point and emerges on the other side of the lens in a direction parallel to the direction of the incident ray.

Oblique Photograph: A photograph taken with the axis of the camera intentionally directed so that it is neither vertical nor horizontal.

Orthographic: Characterized by perpendicular lines or right angles.

Orthophotograph: A photographic reproduction in which each image has been extrapolated into its map-oriented (orthographic project) position.

Overlap: The amount by which two adjacent photographs show the same area. This amount is usually expressed as a percentage of the total linear dimension of the photograph in the direction of the overlapping.

In aerial photographs, the overlap within the flight line is called the end lap, and the overlap in adjacent parallel flight lines is called the side lap.

Panels: Ground control points which are readily identifiable in aerial photographs. Also referred to as Targets.

Parallax: (1) An apparent change in position of one object relative to another when viewed from different positions. (2) The change in position of an image from one aerial photograph to the next as a result of the aircraft's motion.

Photogrammetry: The science of obtaining accurate measurements through the use of aerial photographs and stereoplottting equipment.

Photographic Index: A mosaic of individual adjacent photographs in their proper relative positions and re-photographed at a reduced scale with accompanying designations.

Plane Coordinate System: A horizontal reference system consisting of equally spaced perpendicular and parallel grid lines used to locate and establish the horizontal position of any point. Such positions are established relative to the point of origin and principal axes of this system. The two primary systems employed in New Jersey are the National Geodetic Survey and the New Jersey State Plane Coordinate System (NJSPCS (1927)/NJSPCS (1988), and generally all first and second order accuracy traverses and triangulation stations should be tied into one of these systems unless the NJDOT approves otherwise.

Planimetry: The configuration of a surface and the horizontal positions of its natural and cultural features, depicted by means of lines, symbols and notations on a scaled map or plan sheet without regard to relief.

Plans: The approved plans, profiles, typical sections, cross sections, shop drawings and supplemental drawings or exact reproductions thereof, which show the location, extent, layout and dimensions as well as the scope, character, and details of the work to be done.

Precision: The degree of refinement with which an operation is performed.

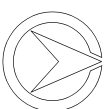

Principal Point: (1) The intersection of two lines drawn through pairs of opposite fiducial marks on an aerial photograph. (2) The theoretical intersection of the camera's line of sight axis, directed as vertically as possible, with the ground.

Print: A photographically produced copy of a transparency. Also called a contact print.

Print, Check: A blue or black line copy of an original transparency used as a working copy to check the accuracy of the transparency and to perform related engineering work thereon.

Print, Contact: A print made with a transparency in contact with a sensitized surface.

Print, Cronapaque: A mylar-type, emulsion-coated material with a very low coefficient of expansion and extreme durability upon which a contact print may be produced.

Print, Paper: An emulsion-coated, high grade paper used for the same purposes as the Cronapaque print, but available in single or double weights and in gloss, semi-matte or matte, and in resin-coated finishes.

Print, Ratio: A print on which the scale has been changed from that of the original transparency by project printing.

Project: The specific section of highway or public improvement together with all appurtenances and construction to be performed thereon under the Contract.

Proposal: The offer of a bidder, properly signed and guaranteed, on the prepared from furnished by the NJDOT, to perform the work and to furnish the labor and materials at the prices quoted.

Rectification: The production of a truly vertical photographic print from a tilted aerial negative.

Scale: The ratio of a distance on an aerial photograph, map or plan sheet to its actual counterpart on the ground. Scale may be expressed as a ratio (1:24 000), a representative fraction (1/24 000), or an equivalence (1cm = 24 000cm). The photographic scale is generally taken as "f/h" where "f" is the principal distance of the camera and "h" is the height of the camera above mean ground elevation in metric.

Scribing: A method of drafting which removes a pigment from a coated mylar as a result of tracing a line thereon. Transparent lines are thus produced on the mylar from which, upon completion, prints can be readily made.

Specifications: The state of New Jersey Department of Transportation, Aerial Photogrammetric Specifications of October 1995, including latest revisions.

Spot Elevations: Reported elevations of high, low and other prominent points. The precise location is generally denoted by a small "x" and is thereby accompanied by the reported value of the elevation.

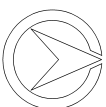

**Stereocomparator:** A comparator used in stereoscopically measuring images on adjacent aerial photographs.

**Stereoplotter:** An instrument designed to produce stereoscopic images or models from which very precise topographic maps can be compiled by utilizing electromechanical components of the instrument.

**Stereoscopy:** The science of producing three dimensional images by viewing the overlap area of two photographs through a binocular viewer. The overlapping photographs are produced with the camera at a slightly different location or perspective of one exposure relative to the other.

**Stereotriangulation:** Triangulation is a procedure dealing with locating and establishing a position by means of bearings from two fixed points a known distance apart. The application of this procedure in photogrammetry utilizes a stereoscopic plotting instrument to obtain successive orientations of adjacent photographs into a continuous strip. The spatial solution for the extension of horizontal and vertical control using strip coordinates may be made by either graphical or computational procedures. Also referred to as Aerial Analytical Triangulation.

**Supplemental Control:** One or more surveys between basic or primary control points to establish any additional points needed to complete the required mapping.

**Target:** A symmetrical pattern in high contrast to the background against which it is placed, it is used in locating and working with a specific control point from an aircraft and especially with its corresponding image in an aerial photograph.

**Tilt:** The departure of the camera's line of sight from vertical.

**Topography:** The configuration of a surface including its relief (usually represented by contours and spot elevations) and the positions of its natural and cultural features as shown on a map or plan.

**Total Station:** A vertical and horizontal angle-measuring instrument with an electronic distance-measuring device either attached to or integral with the telescope and containing decoders which convert angle measurements to digital form. Such instruments make data immediately available on slope, horizontal distances and differences in elevations. They may also compute horizontal coordinates and elevations. Some are equipped to record all data on computer-compatible data storage media.

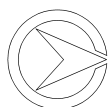

## APPENDIX A

### FEDERAL GEODETIC CONTROL COMMITTEE MEMBERSHIP

The Federal Geodetic Control Committee (FGCC), chartered in 1968, assists and advises the Federal Coordinator for Geodetic Control and Related Surveys. The Federal Coordinator for Geodetic Control is Responsible for Coordinating, planning, and executing national geodetic control surveys and related survey activities of Federal agencies.

The Methodology Subcommittee of FGCC is responsible for revising and updating the Standards and Specifications for Geodetic Control Networks.

#### MEMBER ORGANIZATIONS:

- Department of Commerce
- Department of Agriculture
- Department of Defense
- Corps of Engineers, U.S. Army
- Department of Energy
- Department of Housing and Urban Development
- Department of Interior
- Department of Transportation
- National Aeronautics and Space Administration
- Bureau of Land Management
- International Boundary Commission

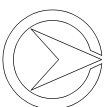

## APPENDIX B

### ONE-DIMENSIONAL AND THREE-DIMENSIONAL (ELLIPSOIDAL AND SPHERICAL) ERRORS

Suppose the value  $m$  quantifies one of the components of the relative position between two marks, which may be, for example, relative height or the east-west base line component. Then the term “relative accuracy” for  $m$  will be defined as the ratio,  $\epsilon/d$ , where the interval  $m^-$  to  $m^+$  corresponds to the 95% confidence region for  $m$  while  $d$  equals the distance between two marks and  $\epsilon$  equals the component error.

For a network of stations surveyed by GPS relative positioning techniques the three components of the relative position can be determined. The term “relative position accuracy” denotes the relative accuracy of the various components for a representative pair of network marks. Consequently, a GPS network is said to have a relative positioning accuracy of 1 ppm (1:1 000 000) when each component of a representative base line has a relative accuracy of at least 1 ppm. The concept of relative position accuracy can be applied to networks where relative positions have been determined either by single-dimensional measurement or by three-dimensional space-based measurements (R. Snay, NGS, 1986 personal communications).

Accuracy standards for geometric relative positioning are based on the assumption that errors can be assumed to follow a normal distribution. Normal distribution applies only to independent random errors, assuming that systematic errors and blunders have been eliminated or reduced sufficiently to permit treatment as random errors. Although, truly normal error distribution seldom occurs in a sample of observations, it is desirable to assume a normal distribution for ease of computation and understanding.

A three-dimensional error is the error in a quantity defined by three random variables. The components of a vector base line can be expressed in terms of  $dX$ ,  $dY$ , and  $dZ$ . It is assumed that the spherical standard error ( $\sigma_s$ ) is equal to the linear standard error for the components or  $\sigma_s = \sigma_x = \sigma_y = \sigma_z$ .

A one-sigma spherical standard error ( $\sigma_s$ ) represents 19.9 percent probability. This compares to a one-sigma linear standard error ( $\sigma_x$ ) which represents 68.3 percent probability. At the 95 percent probability or confidence level, the spherical accuracy standard is  $2.79\sigma_s$  compared to  $1.96\sigma_x$  for a linear accuracy standard (Greenwalt and Shultz 1962).

The probability level of 95 percent is consistent with the Standards and Specifications for Geodetic Control Network (FGCC 1984). One page 1-2 of this document, it is stated “. . . a safety factor of two . . .” is “. . . incorporated in the standards and specifications.” Since those accuracy standards were based on one-dimensional errors that exist in such positional data as elevation differences and observed lengths of lines, the factor of two, a  $2\sigma_x$  linear accuracy standard, is a probability of confidence level of about 95 percent.

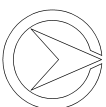

## APPENDIX C

**CONVERSION OF MINIMUM GEOMETRIC ACCURACIES AT THE 95 PERCENT  
CONFIDENCE LEVEL FROM FIGURE 4-5 TO MINIMUM “ONE-SIGMA” STANDARD  
ERRORS**

The “one-sigma” three- and one-dimensional standard errors are computed by:

$$\sigma_s = p/2.79 \quad \text{and,} \quad \sigma_x = p/1.96$$

where, p = minimum geometric relative accuracies in (ppm) at the 95 percent confidence level

$\sigma_s$  = “one-sigma” three-dimensional minimum error (ppm)

$\sigma_x$  = “one-sigma” one-dimensional minimum error (ppm)

**Table 10-1: “One-Sigma” Errors for Corresponding Minimum Geometric Accuracies at the 95 Percent Confidence Level**

ORDER	CLASS	RELATIVE ACCURACIES (95 PERCENT) CONFIDENCE LEVEL		MINIMUM GEOMETRIC “ONE-SIGMA” STANDARD ERRORS			
		p (ppm)	a (1:a)	THREE-DIMENSIONAL ( $\sigma_s$ )		ONE-DIMENSIONAL ( $\sigma_x$ )	
				(ppm)	(1:T)	(ppm)	(1:L)
AA	--	0.01	1:100 000 000	0.0036	1:279 000 000	0.005	1:200 000 000
A	--	0.1	1:10 000 000	0.036	1:27 900 000	0.05	1:20 000 000
B	--	1	1:1 000 000	0.36	1:2 790 000	0.5	1:2 000 000
1	--	10	1:100 000	3.58	1:279 000	5	1:200 000
2	I	20	1:50 000	7.17	1:140 000	10	1:100 000
2	II	50	1:20 000	17.9	1:56 000	25	1:40 000
3	I	100	1:10 000	35.8	1:28 000	50	1:20 000

5-11-88

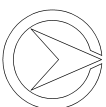

## APPENDIX D

## EXPECTED MINIMUM/MAXIMUM ANTENNA SETUP ERRORS

$k$  = the repeatable setup error in (CM) for any component (horizontal and vertical) at the 95 percent confidence level

$$k = 0.1pd (\beta), \quad \text{where, } k_{\min} = 0.3 \text{ CM and } k_{\max} = 10 \text{ CM}$$

NOTE: The value for  $k_{\min}$  is based on current estimates for expected setup errors when the antenna is set on a tripod at a total height of less than 5 M. When the antenna is set on a mast or tower where the height is greater than 5 M, the estimated minimum value for  $k$  may be greater than 0.3 CM. On the other hand, if the antenna is mounted on a fixed or permanently installed stand, than  $k_{\min}$  should be less than 0.1 CM.

The value for  $k_{\max}$  is the expected largest value for the setup error; in practice, it should be much smaller than 10 CM, typically less than 1 CM.

$p$  = minimum geometric accuracy standard in parts-per-million (ppm).

$d$  = distance between any two stations of a survey (KM).

$\beta = 0.05$  = critical region factor for the 95 percent confidence level ( $1.00 - 0.95 = 0.05$ ).

To convert setup error at the 95 percent confidence level to standard error (one-sigma), divide  $K$  by: 1.96 for 'linear' standard error, or 2.79 for 'spherical' standard error.

**Table 10-2: Setup Errors (K) in Centimeters at 95 Percent Confidence Level**

ORDER	p (ppm)	d = DISTANCE BETWEEN STATIONS (KM)										
		0.01	0.05	0.1	0.5	1	5	10	50	100	500	1000
AA	0.01	0.3	0.3	0.3	0.3	0.3	0.3	0.3	0.3	0.3	0.3	0.3
A	0.1	0.3	0.3	0.3	0.3	0.3	0.3	0.3	0.3	0.3	0.3	0.3
B	1	0.3	0.3	0.3	0.3	0.3	0.3	0.3	0.3	0.5	2.5	5
1	10	0.3	0.3	0.3	0.3	0.3	0.3	0.5	2.5	5	(10)	(10)
2-I	20	0.3	0.3	0.3	0.3	0.3	0.5	1.0	5	(10)	(10)	(10)
2-II	50	0.3	0.3	0.3	0.3	0.3	1.2	2.5	(10)	(10)	(10)	(10)
3-I	100	0.3	0.3	0.3	0.3	0.5	2.5	5	(10)	(10)	(10)	(10)

8-01-89

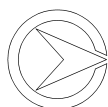



## APPENDIX E

### ELEVATION DIFFERENCE ACCURACY STANDARDS FOR GEOMETRIC RELATIVE POSITIONING TECHNIQUES

An elevation difference accuracy is the minimum allowable error at the 95 percent confidence level. For simplicity and ease of computations, elevation differences (dH) are assumed to be equal to orthometric height differences.

The height differences determined from space survey systems, such as GPS satellite surveying techniques, are with respect to a reference ellipsoid. These ellipsoid (geodetic) height differences (dh) can be converted to elevation differences (dh) by the relationship:

$$(dh) = (dH) - (dN)$$

where (dN) is the geoid height difference.

With accurate estimates for (dN) and adequate connections by GPS relative positioning techniques to network control points tied to National Geodetic Vertical Datum, elevations can be determined for stations with unknown or poorly known values.

**NOTE:** If GPS ellipsoid height differences are being measured for the purpose of monitoring the change in height between stations, then it is not necessary to have any accurate information on the shape of the geoid. Thus, the accuracy of the height difference depends only on the accuracy of the GPS ellipsoid height differences.

The accuracy of the GPS derived elevations for points in a survey will depend on three factors: (1) accuracy of the GPS ellipsoid height differences, (2) accuracy of the elevations for the network control, and (3) accuracy of the geoid height difference estimates.

In Table 10-3, elevation difference accuracy standards at the 95 percent confidence level are proposed. The order/class correspond to the proposed geometric relative position accuracy standards. At the high orders, the error is dominated by the accuracy for the (dN) values, whereas, for the lower orders, the major source of error is in the ellipsoid height differences.

**NOTE:** In developing these standards, it is assumed that errors or inconsistencies in the vertical network control are negligible. Of course, this may not be true in many cases.

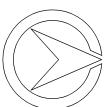
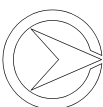

**Table 10-3: Elevation Difference Accuracy Standards for Geometric Relative Positioning Techniques**

(95 PERCENT CONFIDENCE LEVEL)						
ORDER	CLASS	MINIMUM ELEVATION DIFFERENCE ACCURACY STANDARD		(FROM TABLE 4-4) MINIMUM GEOMETRIC RELATIVE POSITION ACCURACY STANDARD	MINIMUM GEOID HEIGHT DIFFERENCE ACCURACY STANDARD	
		$p_H$ (ppm)	1:e	$p$ (ppm)	$p_N$ (ppm)	1:n
AA	--	2	1:500 000	0.1	2	1:500 000
A	--	2	1:500 000	0.1	2	1:500 000
B	--	5	1:200 000	1	5	1:200 000
1	--	15	1:67 000	10	10	1:100 000
2	I	20	1:50 000	20	10	1:100 000
2	II	50	1:20 000	50	20	1:50 000
3	I	100	1:10 000	100	40	1:50 000

**Note:** THESE ELEVATION DIFFERENCE ACCURACY STANDARDS ARE TO BE USED ONLY FOR ELEVATION DIFFERENCES DETERMINED INDIRECTLY FROM ELLIPSOID HEIGHT DIFFERENCE MEASUREMENTS.

FOR DIRECT VERTICAL MEASUREMENT TECHNIQUES SUCH AS DIFFERENTIAL OR TRIGONOMETRIC LEVELING, USE ONLY THE ACCURACY STANDARDS GIVEN IN THE FGCC 1984 DOCUMENT, SECTION 2.2, PAGES 2-2 AND 2-3. 5-11-88



## APPENDIX F

### PLANNING THE GPS SURVEY OBSERVING SCHEDULE

$r$  = The number of GPS receivers used for each observing session

$n$  = Minimum number of independent occupations per each station of a project

- If  $n = 1$ , (no check, no redundancy)
- If  $n = 1.5$ , (50 percent or more stations with 2 or more occupations)
- If  $n = 1.75$ , (75 percent or more stations with 2 or more occupations)
- If  $n = 2$ , (100 percent check, adequate redundancy)
- If  $n = 3$ , (excellent check, highest confidence)

NOTE: when  $r = 2$ ,  $n$  will always be 2 or greater.  
when,  $r > 2$ , then  $n = 1, 2, 3$ , or more occupations.

$m$  = Total stations for the project (existing and new)

$s$  = Number of observing sessions scheduled for the project

$d$  = Average number of observing sessions scheduled per observing day (e.g. 1 per day, 2 per day, 2.5 per day, etc.)

NOTE: Depends on required observing span, satellite availability, and transportation requirements.

$x$  = Number of observing days, where  $x = s/d$

$y$  = Number of observing days scheduled per week, generally 5 to 7.

$w$  = Number of workweeks, where  $w = x/y = s/(d \cdot y)$

$p$  = Production factor (based on historical evidence of reliability; ratio of proposed observing sessions for a project versus final number of observed sessions)

$$p = f/i,$$

where:  $f$  = final number of observing sessions required to complete the project

$i$  = Proposed (initial) number of observing sessions scheduled for the project,

$$\text{where: } i = (m \cdot n)/r$$

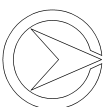

**FORMULAS:**

$$s = (m \cdot n)/r + (m \cdot n) (p-1)/r + k \cdot m$$

where, k is a safety factor: k = 0.1 for local projects; within 100 KM radius.  
k = 0.2 for all other projects

x = estimated number of observing days for a project:  $x = s/d$

w = estimated number of work-weeks for a project:  $w = x/y$

v = estimated total vectors for a project:  $v = r \cdot s (r-1)/2$

b = estimated independent vectors for a project:  $b = (r-1)s$

**EXAMPLE:**

If

n = 1.75	independent occupations per station
m = 50	total stations for project
y = 5	observing days per week
k = 0.2	safety factor
r = 4	number of GPS receivers per observing session
d = 2.5	average observing sessions per day
p = 1.1	production factor

Then

s = 22 + 3 + 10 = 35	observing sessions
x = 14	observing days
w = 2.8	workweeks
b = 105	independent vectors

**COMMENTS:**

In the equation to compute the number of observing sessions (s), if there were no sessions lost due to receiver malfunctions, and no additional sessions required to cover such factors as human error and irregular network configuration, then

$$s = (m \cdot n)/r$$

However, the second part of the equation for computing "s" is to allow for additional sessions to offset scheduled sessions that may be lost due to equipment breakdown.

The third part of the equation, k(m), allows for additional sessions that may be required due to human error, irregular network configuration, etc.

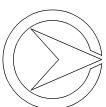

APPENDIX G

EXAMPLES OF GPS SURVEYS WITH SUMMARY OF STATISTICS USED TO CLASSIFY THE ORDER OF SURVEY BASED ON THE OBSERVING SCHEME AND DATA COLLECTION PROCEDURES

EXAMPLE 1:

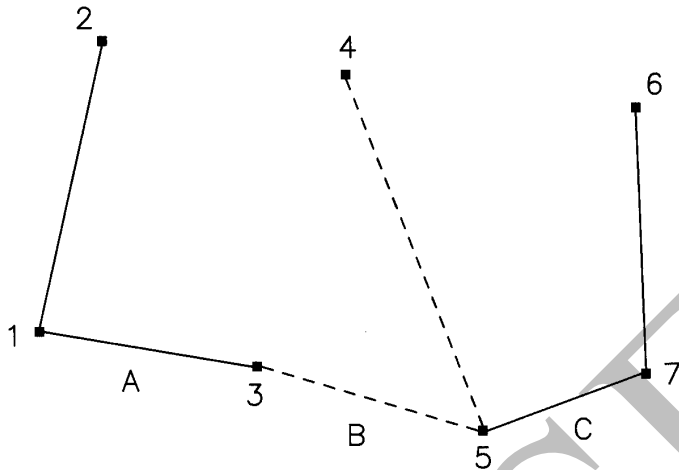

NOTE: Only nontrivial (independent) base lines are shown.

Observing sessions, total number (A, B, and C)	3
Receivers observing simultaneously	3
Stations, total number	7
Station occupations	
Single occupations (no redundancy)	5
Two or more occupations, number/percent of all stations	2/29
Three or more occupations, number/percent of all stations	0/0
Base lines determined:	
All (trivial and nontrivial)	9
Independent (nontrivial)	6
Repeat base lines (N-S/E-W/percent of nontrivial)	0/0/0
Loop closure analyses:	
Valid loops formed?/Number of stations that can't be included	No/7
Loops containing base lines from (2 or)/(3 or more) sessions?	0/0
Geometric relative position classification (based on Table 4-7)	None

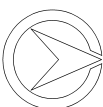

**EXAMPLE 2:**

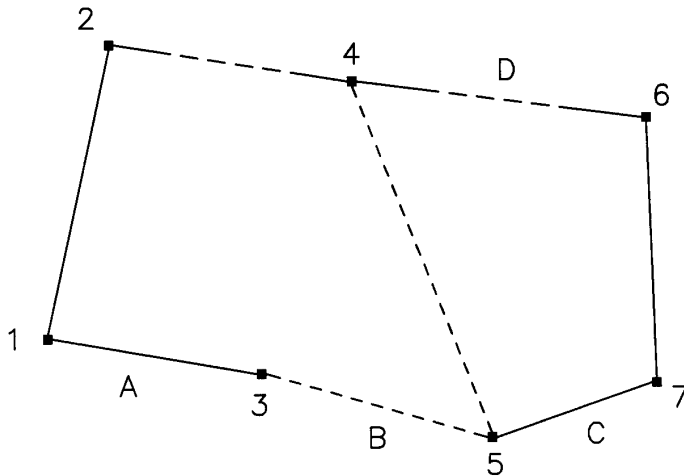

NOTE: Only nontrivial (independent) base lines are shown.

Observing sessions, total number (A, B, C, and D)	4
Receivers observing simultaneously	3
Stations, total number	7
Station occupations:	
Single occupations (no redundancy)	2
Two or more occupations number/percent of all stations	5/71
Three or more occupations number/percent of all stations	0/0
Base lines determined:	
All (trivial and nontrivial)	12
Independent (nontrivial)	8
Repeat base lines (N-S/E-W/percent of nontrivial)	0/0/0
Loop closure analyses:	
Valid loops formed?/Number of stations that can't be included	Yes <sup>(a)</sup> /0
Loops containing base lines from (2 or)/(3 or more) sessions?	0/2
Geometric relative position classification (based on Table 4-7)	Order "2-II"
<hr/>	
(a) Loops formed:	
1 - 1(A)3 + 3(B)5 + 5(B)4 + 4(D)2 + 2(D)1	Includes 3 sessions
2 - 5(C)7 + 7(C)6 + 6(D)4 = 4(B)5	Includes 3 sessions

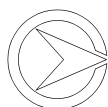

**EXAMPLE 3:**

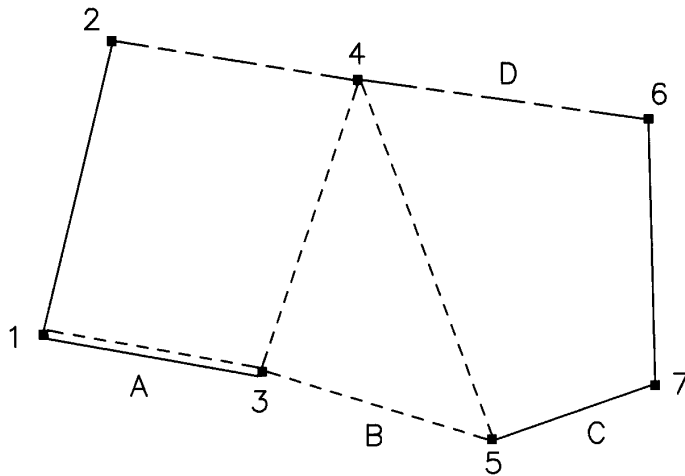

NOTE: Only nontrivial (independent) base lines are shown.

Observing sessions, total number (A, B, C, D, and E)	5
Receivers observing simultaneously	3
Stations, total number	7
Station occupations:	
Single occupations (no redundancy)	1
Two or more occupations, number/percent of all stations	6/86
Three or more occupations, number/percent of all stations	2/29
Base lines determined:	
All (trivial and nontrivial)	15
Independent (nontrivial)	10
Repeat base lines (N-S/E-W/percent of nontrivial)	0/1/10
Loop closure analyses:	
Valid loops formed?/Number of stations that can't be included	Yes <sup>(a)</sup> /0
Loops containing base lines from (2 or)/(3 or more) sessions?	1/2
Geometric relative position classification (based on Table 4-7)	Order "1"
<hr/>	
a) Loops formed:	
1 - 1(A)3 + 3(E)4 + 4(D)2 + 4(A)1	Includes 3 sessions
2 - 3(B)5 + 5(B)4 + 4(E)3	Includes 2 sessions
3 - 5(C)7 + 7(C)6 + 6(D)4 + 4(B)5	Includes 3 sessions

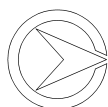

**EXAMPLE 4:**

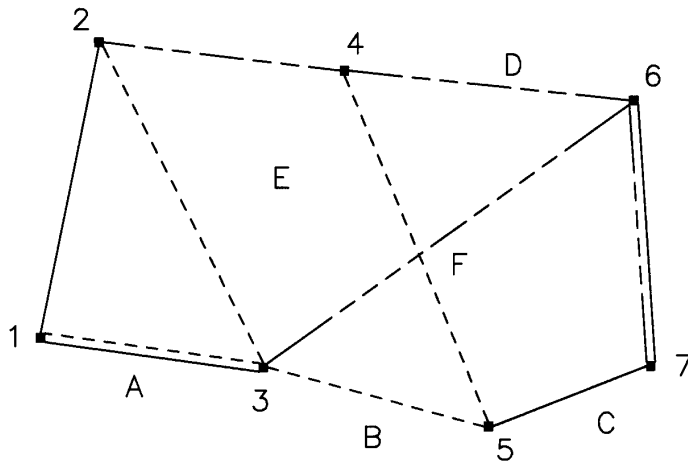

NOTE: Only nontrivial (independent) base lines are shown.

Observing sessions, total number (A, B, C, D, E, and F)	6
Receivers observing simultaneously	3
Stations, total number	7
Station occupations:	
Single occupations (no redundancy)	0
Two or more occupations, number/percent of all stations	7/100
Three or more occupations, number/percent of all stations	3/43
Base lines determined:	
All (trivial and nontrivial)	18
Independent (nontrivial)	12
Repeat base lines (N-S/E-W/percent of nontrivial)	2/1/25
Loop closure analyses:	
Valid loops formed?/Number of stations that can't be included	Yes <sup>(a)</sup> /0
Loops containing base lines from (2 or)/(3 or more) sessions?	0/4
Geometric relative position classification (based on Table 4-7)	Order "B"

NOTE: If one additional session was observed where session G would include stations 1, 2 and 5 (or 7), then the survey would be classified with an Order of "A".

(a) Loops formed:	1 - 1(A)3 + 3(E)4 + 4(D)2 + 2(A)1	Includes 3 sessions
	2 - 3(B)5 + 5(C)7 + 7(C)6 + 6(F)3	Includes 3 sessions
	3 - 6(D)4 + 4(B)5 + 5(C)7 + 7(F)6	Includes 3 sessions
	4 - 1(E)3 + 3(B)5 + 5(B)4 + 4(E)2 + 2(A)1	Includes 4 sessions

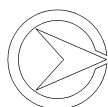



## APPENDIX H

### SPECIFICATIONS AND SETTING PROCEDURES FOR THREE-DIMENSIONAL MONUMENTATION (May 11, 1988)

#### 1. Materials required for each marker:

- a. Rod, stainless steel, 1.2 M sections
- b. Rod, stainless steel, one 100 MM - 130 MM
- c. Studs, stainless steel, 10 MM
- d. Datum point, stainless steel, 10 MM bolt
- e. Spiral (fluted) rod entry point, standard
- f. NGS logo caps, standard, aluminum
- g. Pipe, schedule 40 PVC, 130 MM inside diameter, 600 MM length
- h. Pipe, schedule 40 PVC, 25 MM inside diameter, 900 MM length
- i. Caps, schedule 40 PVC, (Slip-on caps centered and drilled to 15 MM  $\pm$  0.002)
- j. Cement for making concrete
- k. Cement, PVC solvent
- l. Loctite (2 oz. bottle)
- m. Grease
- n. Sand (washed or play)

#### 2. Setting procedures:

- a. The time required to set an average mark using the following procedures is 1 to 2 hours.
- b. Using the solvent cement formulated specifically for PVC, glue the aluminum logo cap to a 600 MM section of 130 MM PVC pipe. This will allow the glue to set while continuing with the following setting procedures.
- c. Glue the PVC cap with a drill hole on one end of a 900 MM section of schedule 40 PVC pipe 25 MM inside diameter. Pump the PVC pipe full of grease. Thoroughly clean the pen end of the pipe with a solvent which will remove the grease. Then glue another cap with drill hole on the remaining open end. Set aside while continuing with the next step.
- d. Using a power auger or post hole digger, drill or dig a hole in the ground 300 - 355 MM in diameter and 1.0 M deep.
- e. Attach a standard spiral (fluted) rod entry point to one end of a 1.2 M section of stainless steel rod with the standard 10 MM stud. On the opposite end screw on a short 100 - 130 MM piece of rod which will be used as the impact point for driving the rod. Drive this section of rod with a reciprocation driver such as Whacker model BHB 25, Pionjar model 120, or another machine with an equivalent driving force.
- f. Remove the short piece of rod used for driving and screw in a new stud. Attach another 1.20 M section of rod. Tighten securely. Reattach the short piece of rod and drive the new section into the ground.
- g. Repeat step 6 until the rod refuses to drive further. The top of the rod should terminate about 76 MM below the ground surface.

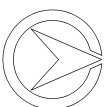

- h. When the desired depth of the rod is reached, cut off the top removing the tapped and threaded portion of the rod leaving the top about 76 MM below ground surface. The top of the rod then must be shaped to a smooth rounded (hemispherical) top, using a portable grinding machine to produce a datum point. The datum point must then be center punched to provide a plumbing (centering) point.

NOTE: For personnel that may not have the proper cutting or grinding equipment to produce the datum point, the following alternative procedure should be used if absolutely necessary. When the desired depth of the rod is obtained (an even 1.2 M section), thoroughly clean the thread with a solvent to remove any possible remains of grease or oil that may have been used when the rod was tapped. Coat the threads of the datum point with Loctite and screw the datum point into the rod. Tighten the point firmly with vise grips to make sure it is secure. The datum point is a stainless steel 10 MM bolt with the head precisely machined to 14 MM.

- i. Insert the grease filled 900 MM section of 25 MM PVC pipe (sleeve) over the rod. The rod and datum point should protrude through the sleeve about 76 MM.
- j. Backfill and pack with sand around the outside of the sleeve to below ground surface. Place the 130 MM PVC and logo cap over and around the 25 MM sleeve and rod. The access cover on the logo cap should be flush with the ground. The datum point should be about 76 MM below the cover of the logo cap.
- k. Place concrete around the outside of the 130 MM PVC and logo cap, up to the top of the logo cover. Trowel the concrete until a smooth neat finish is produced.
- l. Continue to backfill and pack with sand inside the 130 MM PVC and around the outside of the 25 MM sleeve and rod to about 25 MM below the top of the sleeve.
- m. Remove all debris and excess dirt to leave the area in the condition it was found. Make sure all excess grease is removed and the datum point is clean.

