

NEW JERSEY DEPARTMENT OF TRANSPORTATION

SOIL EROSION AND SEDIMENT CONTROL STANDARDS

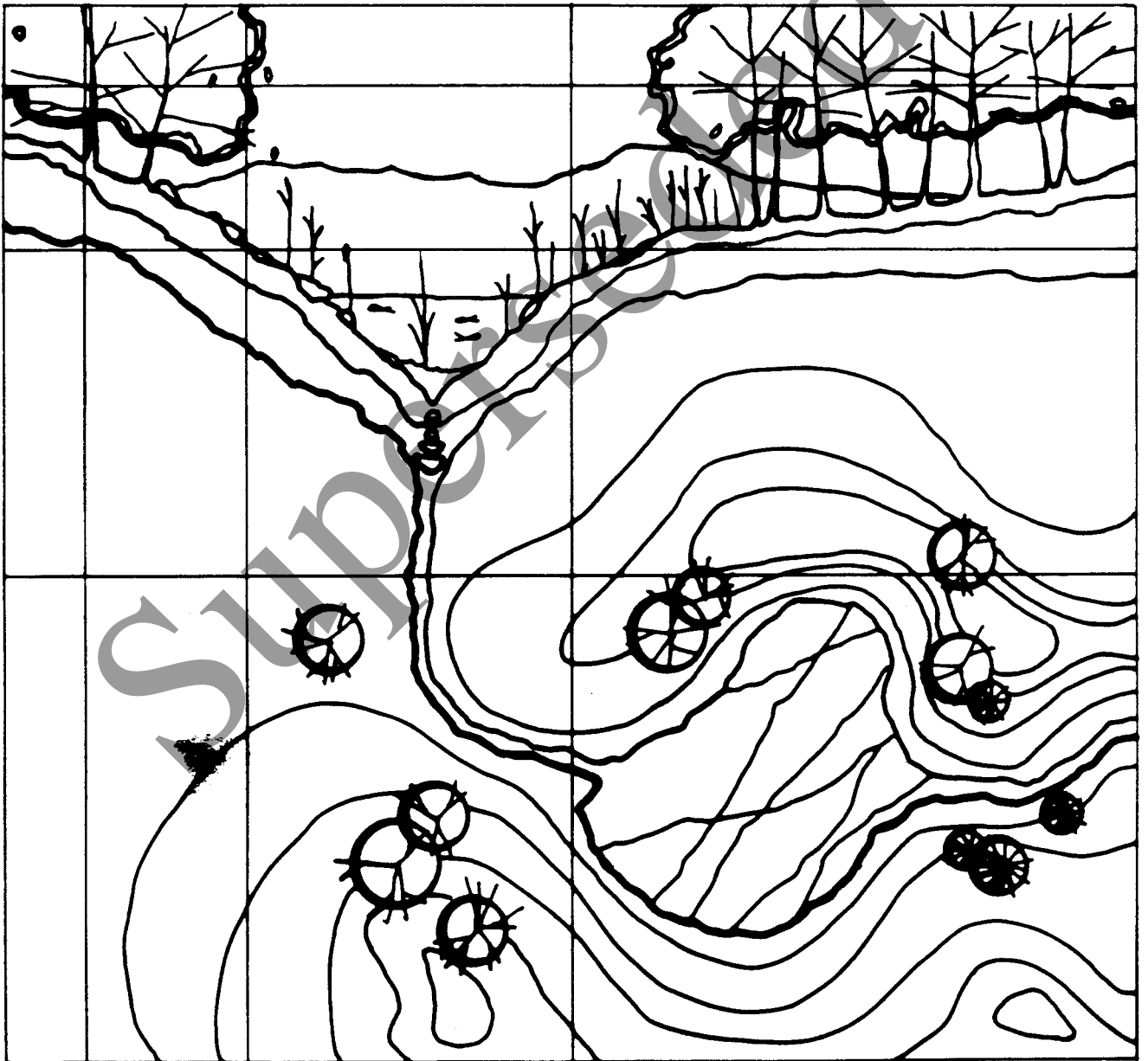

Superseded

State of New Jersey
Department of Transportation

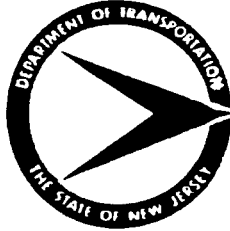

SOIL EROSION
AND
SEDIMENT CONTROL MANUAL

Submitted by: Charles P. Monahan 01-12-89
Date
Charles P. Monahan, Manager
Bureau of Landscape Architecture

Frank Scymanski 18 Jan 89
Date
Frank Scymanski, Manager
Bureau of Roadway Design Standards

Concurrence by: Edwin W. Dayton 1/18/89
Date
Edwin W. Dayton, Director
Division of Roadway Design

Approved by: Kenneth C. Afferton 1-18-89
Date
Kenneth C. Afferton, Assistant Commissioner
Design and Right of Way

Manual No. 185

Superseded

TABLE OF CONTENTS

Table of Contents	i
Introduction	iii
Purpose	iv
Vegetative Standards	
Temporary Vegetative Cover for Soil Stabilization	1-1-1
Permanent Vegetative Cover for Soil Stabilization	1-2-1
Stabilization with Mulch Only	1-3-1
Permanent Stabilization with Sod	1-4-1
Topsoiling	1-5-1
Selection and Planting of Native and Naturalized Vines, Shrubs and Trees for Critical Area Planting	1-6-1
Tree Protection During Construction	1-7-1
Maintaining Vegetation	1-8-1
Topsoil Stabilization Matting	1-9-1
Slope Boards	1-10-1
Preparation of Existing Soil	1-11-1
Engineering Standards	
Land Grading	2-1-1
Diversion	2-2-1
Grassed Waterway	2-3-1
Sediment Basin	2-4-1
Slope Protection Structures	2-5-1
Channel Stabilization	2-6-1
Detention Basin	2-7-1
Subsurface Drainage	2-8-1
Traffic Control	2-9-1
Dust Control	2-10-1
Lined Waterway	2-11-1
RipRap	2-12-1
Sediment Barrier	2-13-1
Conduit Outlet Protection	2-14-1
Stabilized Construction Entrance	2-15-1
Storm Sewer Inlet Protection	2-16-1
Grade Stabilization Structure	2-17-1
Parking Lot Storage	2-19-1
Roof-top Storage	2-19-1
Underground Tanks	2-20-1
Cut to Fill Slope Treatment	2-21-1
Temporary Dams	2-22-1
Sediment Barrier (Hay Bales)	2-23-1
Inlet Protection - Hay Bale Barrier	2-24-1
Inlet Sediment Trap	2-25-1
Inlet Protection (Temporary Sump-Stone Filter)	2-25-1
Floating Turbidity Barrier	2-27-1
Staked Turbidity Barrier	2-28-1

Superseded

Appendices

The Universal Soil Loss Equation	A1-1
Diversion and Grassed Waterway	A2-1
Sediment Basin Design Procedure	A3-1
Channel Stability Analysis	A4-1
Modified Rational Method	A5-1
References	A6-1
Glossary	A7-1

Superseded

Superseded

INTRODUCTION

The Soil Erosion and Sediment Control Act of 1975 and the 1979 amendments require that all construction projects that disturb 5000 sq. ft. of earth or more shall include measures to protect the environment from soil erosion and sedimentation. Complying with this mandate, the Department of Transportation, in conjunction with the Department of Environmental Protection and the State Soil Conservation Committee, has developed the Vegetative and Engineering Standards in this Manual.

The Department of Transportation will certify to the appropriate Soil Conservation District that the appropriate standards are included in each project, and will be used during construction to comply with the intent of the Act to protect the environment from the effects of soil erosion and sedimentation. The standards were developed for, and are applicable for use, only on NJDOT projects and/or projects within NJDOT Right of Way.

Superseded

PURPOSE

It is the purpose of this manual to supply the engineer with information helpful in the design and construction of soil erosion and sediment control measures for both temporary and permanent conditions.

There may be occurrences when the results produced by following these standards are not reasonable and/or consistent with good engineering judgement in the prevention of soil erosion. Therefore, the engineer shall check to assure that the proposed control feature is reasonable for the given situation.

The engineer may elect to design a soil erosion feature that is consistent with the intent of these standards but not described in this manual. In the event that there is cause to design a soil erosion feature not described in these standards or there is a question concerning the appropriateness of any erosion control measure, the engineer shall contact the Regional Design or Local Aid District office for guidance and the appropriate approval of the NJDOT Drainage Engineer and/or the Chief, Bureau of Landscape Architecture.

Superseded

1-1 STANDARD FOR TEMPORARY VEGETATIVE COVER FOR SOIL STABILIZATION

Definition

Establishment of temporary vegetative cover on exposed soils for the life of the individual contract.

Purpose

To temporarily stabilize the soil and reduce damage from wind and water erosion until permanent stabilization is accomplished.

Where Applicable

On exposed soils that have the potential for causing off-site environmental damage, including but not limited to cut and fill slopes, roadway boxes, topsoil storage piles, detention basins or during project shutdown.

Methods and Materials

Materials for fertilizing and seeding shall conform to the requirements listed below:

Fertilizer

Seed Mixture - Type F

The fertilizer for establishing turf shall be limited to one selection throughout the project. Fertilizer shall be applied in the quantity necessary to supply 60 pounds of nitrogen per acre.

All seeded areas shall be fertilized and straw mulched as specified in standards for stabilization with permanent vegetation.

Seeding shall be completed whenever possible from March 1 to May 15 and from August 15 to October 15 when weather and soil conditions are

suitable. Seeding which cannot be completed during these periods may be performed at other times, when weather and soil conditions are suitable.

TYPE F SEED

KIND OF SEED	MINIMUM PURITY, PERCENT	MINIMUM GERMINATION, PERCENT	RATE
PERENNIAL RYEGRASS	95	90	100lb/ACRE

Superseded

Definition

Establishment of permanent vegetative cover on exposed soils where perennial vegetation is needed for long term protection.

Purpose

To permanently stabilize the soil, assuring conservation of soil and water and to enhance the environment.

Where Applicable

On exposed soils that have a potential for causing off-site environmental damage, such as permanent cut or fill slopes, detention basins, median areas and infield areas.

Methods and Materials

Planting beds shall not be fertilized or seeded.

Materials for fertilizing and seeding shall conform to the requirements of the appropriate landscape materials listed below:

Limestone, pulverized

Fertilizer

Seed Mixtures

Grain Seed

Straw Mulch

When the soil to be seeded has a pH value of less than 5.8, suf-

efficient pulverized limestone shall be added to change the soil pH value to 6.5.

Recommended amounts of total oxides (calcium and magnesium) to raise the pH of a four inch layer on different soil textural classes to approximately 6.5 are as follows:

<u>Soil (pH)</u>	<u>Soil Textural Class</u>			
	<u>Pounds of Oxides Per Acre</u>			
	<u>Loamy Sand</u>	<u>Sandy Loam</u>	<u>Loam</u>	<u>Silt Loam</u>
5.7- 6.0	300	600	900	1200
5.3- 5.6	600	1033	1500	1800
4.9- 5.2	900	1500	2100	2400
4.5- 4.8	1200	1800	2700	3000
4.1- 4.4	1500	2100	3300	3600

The total amounts of magnesium and calcium oxides to provide for the above requirements shall be stipulated by the laboratory based on tests run on the soil samples submitted.

Pulverized limestone shall be evenly spread over the area to be seeded at the rate necessary to change the pH value to 6.5.

Before applying seed, all stones, rocks, roots, wires, clods, and other debris measuring 2 inches or more in any dimension shall be removed.

Within the limits set forth under materials the contractor may select the fertilizer he will use. The fertilizer for establishing turf shall be limited to one selection throughout the project. Fertilizer shall be applied in the quantity necessary to yield 60 pounds of nitrogen per acre, 30 pounds at the time of seeding and an additional application of 30

pounds approximately six months after seeding. It is preferred that this second application be made during the months of March or September.

Type A seed mixture shall be sown at the rate of 100 pounds per acre throughout the project.

Type A-3 seed mixture shall be sown at the rate of 100 pounds per acre throughout the project.

Type A-4 seed mixture shall be sown at the rate of 100 pounds per acre throughout the project.

Type B seed mixture shall be sown at the rate of 100 pounds per acre on sandy dry soils occasionally subject to salt water.

Type D seed mixture shall be sown at the rate of 100 pounds per acre in residential and other areas of refined turf, as determined by the engineer.

Type E seed mixture shall be sown at the rate of 110 pounds per acre.

Rye or oat grain shall be sown with only Type A, B and E seed mixtures at the rate of 10 pounds per acre. When seeding in the Spring, oat grain shall be used, in the Fall, rye.

Areas to be seeded shall be friable and shall conform to the prescribed lines and elevations. All seeded areas shall be mulched within 10 days.

Shrub and ground cover plantings shall be mulched separately.

Seeding shall be completed whenever possible from March 1 to May 15 and from August 15 to October 1 when weather and soil conditions are suitable. Seeding which cannot be completed during these periods may be performed at other times when, in the opinion of the engineer, weather and soil conditions are suitable.

Limestone, pulverized

Pulverized limestone shall be composed of calcium and magnesium carbonates, equivalent to not less than 40 percent calcium and magnesium oxides.

Fertilizer

Fertilizer for establishing turf shall have a commercial designation of 10-20-10 or any 1-2-1 ratio fertilizer containing a minimum 5 percent nitrogen, 10 percent available phosphoric acid (P205), and 5 percent soluble potash (K20).

If the fertilizer is to be applied with a mechanical spreader in the dry form, a minimum of 75 percent shall pass a No. 8 sieve and a minimum of 75 percent shall be retained on a No. 16 sieve, and the maximum free moisture content shall be 2 percent.

Fertilizer for establishing sod shall be any 1-2-2 ratio fertilizer containing a minimum of 5 percent nitrogen, 10 percent available phosphoric acid (P205), and 10 percent soluble potash (K20).

All fertilizers shall be uniform in composition, free flowing and suitable for application.

Type A Grass Seed Mixture

used to encourage
Basic Highway Mix - natural vegetation

KIND OF SEED	MINIMUM PURITY, PERCENT	MINIMUM GERMINATION, PERCENT	PERCENT OF TOTAL WEIGHT OF MIXTURE
Kentucky Bluegrass	85	75	20
Red Fescues (Creep- ing or Chewings)	95	80	35
Kentucky 31	95	80	20
Redtop	92	85	10
Perennial Ryegrass	98	85	10
White Clover	97	90	5

Type A-3 Seed Mixture

used as basic seed mix for
Basic Highway Mix - normal seed bed conditions

KIND OF SEED	MINIMUM PURITY, PERCENT	MINIMUM GERMINATION, PERCENT	PERCENT OF TOTAL WEIGHT OF MIXTURE
Tall Fescue (Rebel or Falcon)	95	80	60
Kentucky Bluegrass (Kenblue, South Dakota or Park)	85	75	10
Chewings Fescue (Banner or Jamestown)	95	85	20
Perennial Ryegrass (Linn)	98	85	10

Type A-4 Seed Mixture

used as basic seed mix, inter-
Basic Highway Mix - changeable with A-3 mix

KIND OF SEED	CULTIVAR	PERCENT OF TOTAL WEIGHT OF MIXTURE
Spreading Fescue	Fortress	30
Chewings or Hard Fescue	Banner	30
Kentucky Bluegrass	Kenblue	30
Perennial Ryegrass	Manhattan	10

All grass seed in the above mixture shall be certified seed.

Type B Seed Mixture

Used with sandy dry soils occasionally subject to salt water

KIND OF SEED	MINIMUM PURITY, PERCENT	MINIMUM GERMINATION, PERCENT	PERCENT OF TOTAL WEIGHT OF MIXTURE
Redtop	92	85	10
Red Fescues (Creeping or Chewings)	95	80	40
Blackwells Switchgrass	95	85	10
Reed Canary Grass	96	80	10
Weeping Love Grass	95	85	10
Perennial Ryegrass	98	85	5
Kentucky 31	95	80	15

Type D Seed Mixture

Used in residential areas and where refined turf is needed.

KIND OF SEED	MINIMUM PURITY, PERCENT	MINIMUM GERMINATION, PERCENT	PERCENT OF TOTAL WEIGHT OF MIXTURE
Kentucky Bluegrass	85	75	50
Red Fescues (Creeping or Chewings)	95	85	35
Redtop	92	85	5
Perennial Ryegrass	95	90	10

Type E Seed Mixture

Used only on approval of Chief, Bureau of Landscape Architecture

KIND OF SEED	MINIMUM PURITY, PERCENT	MINIMUM GERMINATION, PERCENT	POUNDS PER 110 POUNDS OF MIXTURE
--------------	-------------------------	------------------------------	----------------------------------

Type A Seed Mixture

Crown Vetch	95	68	10
-------------	----	----	----

Crown Vetch Seed

Crown Vetch seed shall not be added to grass seed mixtures used for fertilizing and seeding, Type A, A-3, A-4, B or D.

Crown Vetch seed shall be inoculated with fresh inoculant immediately before sowing.

Straw Mulch

Areas shall be mulched with straw uniformly spread in a layer 1 to 1½ inches thick; loose measurement, and shall be bound in place with one of the following: asphalt emulsion, synthetic plastic emulsion, fiber mulch, or vegetable based gel.

All mulch shall be left in place and allowed to disintegrate except that excessive amounts of straw shall be removed when necessary.

Straw

Straw shall be the threshed, unrotted stalks of rye, barley or wheat, relatively free from seeds, noxious weeds and other foreign material.

Asphalt Emulsion

Asphalt Emulsion shall be Grade CSS-1, CSS-1h, SS-1, or SS-1h.

The Asphalt Institute's recommendation for rates of application shall be followed.

Synthetic Plastic Emulsion

High polymer synthetic plastic emulsions of mulch binder shall be miscible with all normally available water when diluted to any proportion. After adequate drying, the synthetic plastic binder shall no longer be soluble or dispersible in water, but shall remain tacky until the grass seed has germinated. The plastic binder shall be physiologically harmless and shall not have any phytotoxic or crop damaging properties. The manufacturer's recommendations for rate of application shall be followed.

Fiber Mulch

Fiber Mulch material shall be made from wood or plant fibers containing no growth or germination inhibiting materials. The manufacturer's recommendations for rate of application shall be followed.

Vegetable Based Gels

Vegetable based gel materials, which can be classified as naturally occurring powder based hydrophillic additives formulated to provide gels, which when applied under satisfactory curing conditions, will form membraned networks of water insoluble polymers. The vegetable gel shall be physiologically harmless and shall not have phytotoxic or crop damaging properties. The manufacturer's recommendations for rate of application shall be followed.

Superseded

Superseded

Definition

Stabilizing exposed soils with non-vegetative mulching materials.

Purpose

To protect exposed soil surfaces from erosion damage and to reduce offsite environmental damage.

Where Applicable

This practice is applicable to areas subject to erosion, where the season and other conditions are not suitable for growing an erosion-resistant cover or where stabilization is needed for a short period until more suitable protection can be applied, such as cut and fill slopes, or any newly excavated highly erodable soil.

Methods and Materials

Areas shall be mulched with straw uniformly spread in a layer 1 to 1 1/2 inches thick, loose measurement, and shall be bound in place with one of the following: asphalt emulsion, synthetic plastic emulsion, fiber mulch, or vegetable based gel.

All mulch shall be left in place and allowed to disintegrate except that excessive amounts of straw shall be removed when necessary.

Straw

Straw shall be the threshed, unrotted stalks of rye, barley or wheat relatively free from seeds, noxious weeds and other foreign material.

Asphalt Emulsion

Asphalt Emulsion shall be Grade CSS-1, CSS-1h, SS-1 or SS-1h.

The Asphalt Institute's recommendations for rates of application shall be followed.

Synthetic Plastic Emulsion

High polymer synthetic plastic emulsions for mulch binder shall be miscible with all normally available water when diluted to any proportion. After adequate drying, the synthetic plastic binder shall no longer be soluble or dispersible in water, but shall remain tacky until the grass seed has germinated. The plastic binder shall be physiologically harmless and shall not have any phytotoxic or crop damaging properties. The manufacturer's recommendation for rates of application shall be followed.

Fiber Mulch

Fiber Mulch material shall be made from wood or plant fibers containing no growth or germination inhibiting materials. The manufacturer's recommendations for rates of application shall be followed.

Vegetable Based Gels

Vegetable based gel materials, which can be classified as naturally occurring powder based hydrophylic additives formulated to provide gels, which when applied under satisfactory curing conditions, will form membraned networks of water insoluble polymers. The vegetable gel shall be physiologically harmless and shall not have phytotoxic or crop damaging properties. The manufacturer's recommendation for rates of application shall be followed.

Superseded

Superseded

Definition

Establishing permanent vegetation using topsoiling 4" thick and sod.

Purpose

To permanently stabilize the soil with an immediate aesthetic covering, thus assuring conservation of soil and water, and to enhance the environment.

Where Applicable

On exposed soils that have a potential for causing off-site environmental damage where a quick vegetative cover is desired on small defined areas such as between curb and sidewalks, residential areas and areas directly adjacent to inlets.

Methods and Materials

Prior to placing the sod, 4 inches of topsoil shall be placed in accordance with 1-5.

Immediately before placing the sod, a 1-2-2 ratio fertilizer applied at a rate necessary to yield 50 pounds of nitrogen per acre, and pulverized limestone, if necessary, shall be incorporated into the topsoil. The sod shall be harvested, and within 36 hours, delivered and placed on a 4 inch thick bed of topsoil.

Sod shall be laid with staggered joints and pressed closely together. The ends of sod strips shall be matched so that the ends and sides always lay flush with each other. Sod shall be pressed into the underlying soil by hand tamping and rolling. Then the sodded areas shall be thoroughly watered.

Watering shall be performed as necessary until a firm root mass is established. Each watering shall be performed until water infiltrates through the root zone and into the topsoil zone. The method of watering shall be performed in a manner that provides equal distribution and coverage to all areas sodded.

Sod shall not be transplanted when the moisture content (excessively wet or dry) may adversely affect its survival. Whenever the upper half inch of topsoil is dry, the soil shall be lightly moistened immediately prior to laying the sod.

The finished surface shall be smooth, even and to the prescribed lines and contour. At the time of acceptance all sod shall be alive, healthy and established.

On slopes, placing sod shall start at the bottom. At the top of slopes the upper edge of the sod strips shall be turned into the soil and covered with topsoil. On slopes steeper than 3:1, sod shall be held in place with pegs driven flush with the surface of the sod. The pegs shall be not more than 1 foot apart. No less than 2 pegs shall be used for each strip of sod.

Pasture sod, consisting of sod from pastures or meadows which may have been grown primarily for forage, is not acceptable.

When the item stripping is included on the project and the material to be stripped is found to be acceptable for use as topsoil, topsoiling shall include preparing topsoil stripped from the site of the project and placing it, and furnishing and placing topsoil required in excess of that obtained from stripping.

When the item stripping is not included on the project or stripped material is found to be unacceptable, topsoiling shall include furnishing of topsoil obtained from outside the limits of the project.

Topsoil shall conform to the requirement specified. Shaping and dressing shall include grading to required lines and elevations, the removal of all stones two inches or larger in any dimension and the removal of all other debris such as wires, cables, tree roots, pieces of concrete, clods, lumps, and other unsuitable material.

Topsoil in excess of the quantity required for the project shall be stored in neatly graded storage piles for future use.

Storage piles of topsoil and areas from which stored topsoil has been removed, within the right of way limits of the project, shall be fertilized and seeded.

Sod

Sod shall be machine cut at a uniform soil thickness of 5/8 inch, plus or minus 1/4 inch at the time of cutting. Measurement for thickness shall exclude top growth, and thatch. Individual strips of sod shall be of a uniform width and length. Broken strips and torn or uneven strips may be

rejected. Standard size strips of sod shall be strong enough to support their own weight and retain their size and shape when suspended vertically from the upper 10 percent of the strip.

Sod

Certified sod shall be of the following types:

Kentucky Bluegrass Blend

Kentucky Bluegrass - Fescue Blend

Certified Sod is a superior sod grown from certified grass seed or stolons. The sod is inspected and certified by the N. J. Department of Agriculture to assure genetic identity, purity, and freedom from noxious weeds and excessive amounts of weedy plants.

Topsoil

Topsoil used for topsoiling obtained from stripping within the limits of the project or furnished from outside the project shall contain no stones, lumps, roots or similar objects larger than 2 inches in any dimension, and shall have a pH value of not less than 5.8. When the pH value of the topsoil is less than 5.8 it shall be increased by applying pulverized limestone at a rate necessary to attain a pH value of 6.5.

Material stripped from the following sources shall not be considered suitable for use as topsoil.

Soils having a pH less than 4.1 or greater than 7.0.

Chemically contaminated soils.

Areas from which the original surface has been stripped and/or covered over such as borrow pits, open mines, demolition sites, dumps and sanitary land fills.

Unacceptable wet excavation.

Superseded

Superseded

Definition

Topsoiling entails the distribution of suitable quality soil on areas to be vegetated.

Purpose

To provide an adequate growing medium for the establishment of permanent perennial vegetative cover for long term erosion control.

Where Applicable

On exposed soil areas.

Methods & Materials

Shaping and dressing shall include grading to required lines and elevations, the removal of all stones two inches or larger in any dimension and the removal of all other debris such as wires, cables, tree roots, pieces of concrete, clods, lumps and other unsuitable material.

Topsoil shall be spread in a uniform layer that will produce the prescribed compacted thickness.

Topsoil in excess of the quantity required for the project shall be stored in neatly graded storage piles for future use.

Storage piles of topsoil and areas from which stored topsoil has been removed within the right of way limits of the project, shall be fertilized and seeded.

Topsoil

Topsoil obtained from stripping within the limits of the project or furnished from outside the project shall contain no stones, lumps, roots or similar objects larger than 2 inches in any dimension, and shall have a pH value of not less than 5.8. When the pH value of the topsoil is less than 5.8 it shall be increased by applying pulverized limestone at a rate necessary to attain a pH value of 6.5.

Material stripped from the following sources shall not be considered suitable for use as topsoil.

Soils having a pH less than 4.1 or greater than 7.0.

Chemically contaminated soils.

Areas from which the original surface has been stripped, and/or covered over such as borrow pits, open mines, demolition sites, dumps and sanitary landfills.

Unacceptable wet excavation.

1-6 STANDARD FOR SELECTION AND PLANTING OF NATIVE AND NATURALIZED VINES,
SHRUBS AND TREES FOR CRITICAL AREA PLANTING

Definition

Plants to aesthetically enhance and restore to natural condition disturbed soils.

Where Applicable

Graded or cleared areas subject to erosion, where a permanent, long-lived vegetative cover other than turf is desired.

NATIVE OR ACCEPTABLE EXOTIC PLANT MATERIAL

Although this is by no means a complete listing of the available plant material in these categories, it does include most of that which is commonly used throughout the State of New Jersey.

The services of a Landscape Architect or a Horticulturalist should be utilized for the selection of plant material.

DECIDUOUS TREES

Latin Name

Acer platanoides & varieties
Acer rubrum & varieties
Acer saccharum
Aesculus hippocastanum
Carya ovata
Celtis occidentalis
Fagus grandifolia
Fagus sylvatica & varieties
Fraxinus pennsylvanica lanceolata
& varieties
Ginkgo biloba (grafted male)
& varieties
Gleditsia triacanthos & varieties
Larix decidua
Liquidambar styraciflua
Nyssa sylvatica

Common Name

Norway Maple
Red Maple or Swamp Maple
Sugar Maple
Horsechestnut
Shagbark Hickory
Common Hackberry
American Beech
European Beech

Green Ash
Ginkgo or Maidenhair Tree
(grafted male)
Honeylocust
European Larch
Sweetgum
Black Gum

DECIDUOUS TREES (cont'd)

<u>Latin Name</u>	<u>Common Name</u>
Platanus acerifolia	London Plane Tree
Populus maximowiczii	Japanese Poplar
Populus alba Bolleana	Bolleana Poplar
Quercus borealis	Red Oak
Quercus coccinea	Scarlet Oak
Quercus palustris	Pin Oak
Quercus phellos	Willow Oak
Salix babylonica	Babylon Weeping Willow
Tilia americana	American Linden
Tilia cordata & varieties	Littleleaf Linden
Tilia tomentosa	Silver Linden
Zelkova serrata	Japanese Zelkova

SMALL DECIDUOUS TREES

Acer campestre	Hedge Maple
Acer ginnala	Amur Maple
Amelanchier canadensis	Shadblow Serviceberry
Betula varieties	Birch
Carpinus betulus	European Hornbeam
Carpinus caroliniana	American Hornbeam
Cornus florida	Flowering Dogwood
Cornus kousa	Japanese Dogwood
Cornus mas	Cornelian Cherry Dogwood
Cotinus coggygria	Smokebush
Crataegus crusgalli	Cockspur Thorn
Crataegus phaenopyrum	Washington Hawthorn
Elaeagnus angustifolia	Russian Olive
Hibiscus syriacus	Shrub Althea
Magnolia virginiana	Sweetbay Magnolia
Malus varieties	Crabapples
Oxydendron arboreum	Sorrel Tree or Sourwood
Prunus varieties	Cherries
Pyrus calleryana	Callery Pear
Salix caprea	Goat or Pussy Willow

SHRUBS

Latin Name

Common Name

Aronia arbutifolia	Red Chokeberry
Aronia arbutifolia brilliantissima	Brilliant Chokeberry
Berberis thunbergii	Japanese Barberry
Chaenomeles lagenaria	Flowering Quince
Clethra alnifolia & varieties	Summersweet Clethra
Cornus varieties	Dogwood
Elaeagnus umbellata	Autumn Elaeagnus
Euonymus alata & varieties	Winged Euonymus
Forsythia intermedia & varieties	Border Forsythia
Forsythia suspensa	Weeping Forsythia
Hamamelis varieties	Witchhazel
Ilex glabra	Inkberry
Ilex verticillata	Winterberry Holly
Kalmia latifolia	Mountain Laurel
Ligustrum varieties	Privet
Lindera benzoin	Spicebush
Myrica pensylvanica	Northern Bayberry
Rhododendron maximum	Rosebay Rhododendron
Rhus varieties	Sumac
Rosa varieties	Rose
Syringa vulgaris	Common Lilac
Vaccinium corymbosum	Highbush Blueberry
Viburnum varieties	Viburnum

EVERGREEN TREES

Abies concolor	White Fir
Ilex opaca	American Holly
Juniperus virginiana	Eastern Red Cedar
Picea abies	Norway Spruce
Picea pungens	Colorado Spruce
Pinus strobus	White Pine
Pinus thunbergi	Japanese Black Pine
Pseudotsuga taxifolia	Douglas Fir

GROUND COVERS & VINES

Campsis radicans	Trumpet creeper
Euonymus fortunei vegetus	Winter creeper Euonymus
Hedera helix	English Ivy
Juniperus conferta	Shore Juniper
Juniperus horizontalis plumosa	Andorra Juniper
Lonicera japonica halliana	Halls Japanese Honeysuckle
Parthenocissus quinquefolia	Virginia Creeper
Parthenocissus tricuspidata	Japanese Creeper
Max Graf Rosa	Max Graf Rose
Vitis sp.	Grapes sp.
Wisteria floribunda	Japanese Wisteria
Wisteria sinensis	Chinese Wisteria

Time Of Planting

Broadleaf and coniferous evergreen trees, shrubs, vines and ground covers shall be planted between March 15, and May 15, and between August 15 and December 1. Deciduous trees, shrubs, vines and perennials shall be planted between March 15 and May 15, and between October 15 and December 1.

Planting Beds

All vegetation within proposed planting beds shall be removed and the surface raked and neatly edged. All beds shall be treated with a pre-emergence herbicide such as trifluralin, or its equivalent. The application of herbicides shall comply with the requirements and procedures of N.J.A.C.7:30-1 et seq. The herbicide shall be applied prior to the placing of any mulching materials. Planting beds in areas flatter than 4:1 shall, in addition to the above, be cultivated to a depth of 6 inches.

Planting Pits

Planting pits shall not remain open more than 10 days in advance of planting on slopes steeper than four units horizontal to one vertical.

In medians or other areas close to the roadway where a hazardous condition may result, planting pits shall not remain open beyond the close of the working day unless adequate precautions are taken to warn of their presence and protect the public from injury.

Supporting Trees

All trees 1 inch or more in caliper or more than 3 feet high shall be staked or guyed immediately after planting, except that multi-stemmed,

shrub-like trees, within this caliper and height range, need not be staked.

The following trees shall be staked with one post placed, where possible, on the side of the tree away from the road and set not less than 24 inches in the ground and 9 inches from the tree trunk.

Deciduous trees, except salix (Willow), 1 to 1 1/2 inch caliper, inclusive.

Cone type (pyramidal) trees, 3 to 5 feet high.

Columnar evergreen trees, 4 to 7 feet high, inclusive.

The following trees shall be staked with two posts placed on opposite sides of the trees and set not less than 24 inches in the ground. The posts shall be placed at the perimeter of the ball.

Deciduous trees over 1 1/2 inch to 2 1/1 inch caliper, inclusive.

All Salix (Willow) trees, regardless of height or caliper, bare root, or balled and burlapped.

Columnar evergreen trees, over 7 feet to 9 feet high, inclusive.

Replacement Planting

The requirements for making replacements shall be the same as required for initial planting except for the following:

Existing backfill may be reused.

Wood Chips, if salvagable may be reused. Existing wood chips shall

be completely removed before any earth is excavated for replacement planting. Topsoil shall not be permitted for reuse if it contains wood chip mulch.

At the time plant replacements are made, the contractor shall also remove all weeds and debris from all planting areas.

Replacement plants shall be staked and guyed, and deciduous trees shall be wrapped, all in accordance with this section of the guidelines.

At the time of the acceptance of the replacements, all planting areas throughout the project shall be free of weeds and debris and in a condition as specified for final acceptance.

Replacement of evergreen materials shall be made from March 15 to May 1 and from August 15 to November 15. Replacement of deciduous material shall be made from March 15 to May 1 and from October 15 to November 15.

Two weeks prior to the conclusion of the one year plant replacement period all tree wrapping, stakes, guys and guy wires shall be removed by the contractor, except for replacement plants.

Containerized Plant Material

Immediately prior to planting containerized plant material, the root mass shall receive three vertical cuts, spaced equidistantly about the perimeter. Each cut, about 1/2 inch deep, shall begin at the top of the root mass and continue to the bottom.

Protecting Trees

Tree protectors shall be installed to a height of 2 feet above the ground surface on all newly planted Malus and Crataegus species to prevent damage from bark consuming rodents.

Watering

The initial watering at the time of planting shall be at the rate of 15 gallons per square yard of plant pit area. All plants shall be watered once a week thereafter until the project is finalized. Each watering, after the first, shall provide 5 gallons of water per square yard in the plant pit basin.

More than one watering per week may be required during planting operations or during periods of excessive dryness.

Superseded

Definition

Protection of desirable trees from environmental and mechanical injury during construction activities.

Purpose

To protect desirable trees that have value for erosion and sediment control, shade, aesthetics, song birds, other wildlife, dust control, noise abatement and oxygen production.

Where Applicable

On new development sites containing valuable trees.

Methods and Materials

1. Inventory the development site and clearly mark the trees to be saved. Consider relocating streets, houses or other structures if necessary and feasible.
 - a. Criteria useful in determining the trees to save:
 - (1) Freedom from disease and rot - good, healthy trees.
 - (2) Life span of trees - for example, red maple is short-lived while sugar maple and oaks are long-lived.
 - (3) Aesthetic values - such as autumn foliage, flowering habits, bark and crown appearance, type of fruit, etc.
 - (4) Wind firmness - trees that have been growing in a close stand may blow over easily if unprotected.

- (5) Wildlife values - Oaks, hickories and dogwoods have high food value.
- (6) Shade - summer temperatures are generally 10 degrees cooler under stands of hardwoods than under pines or cedars.
- (7) Sudden exposure - to direct sunlight and ability to withstand radiated heat from proposed building and pavement.
- (8) Space needed - for future growth and relationship to electric and telephone lines, water, sewer or gas lines, driveways, etc.

b. Criteria for protecting remaining trees:

- (1) Mechanical damage - see Figure 1-7-1
- (2) Box trees within 25 feet of a building site to prevent mechanical injury. Fencing or other barrier should be installed at the drip line of the tree branches. See Figure 1-7-1. Boards will not be nailed to trees during building operations.
- (4) Roots should not be cut in an area inside the drip line of the tree branches.
Care for serious injury should be prescribed by a professional forester or tree expert.
- (5) Tree limb removal, where necessary, will be done according to accepted pruning practices.

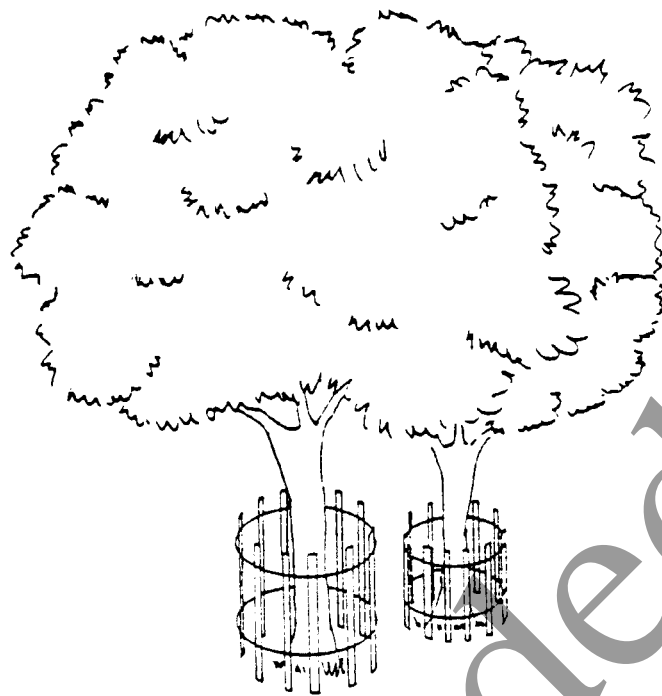

Incorrect fencing for tree protection



Figure 1-7-1 Correct fencing for tree protection

Superseded

Definition

The perpetuation of vegetative cover.

Purpose

To assure the continuing function of the vegetative cover in the conservation of soil and water and the enhancement of the environment. It is usually less costly to carry on a maintenance program than it is to replace or repair vegetation after an extended period of neglect.

Where Applicable

On areas where existing vegetation protects or enhances the environment.

Methods and Materials

A maintenance program anticipates requirement and accomplishes work when it can be done with least effort and expense to insure adequate vegetative cover.

Maintenance should occur on a regular basis, consistent with favorable plant growth, soil and climatic conditions. This involves regular seasonal work for mowing, fertilizing, liming, watering, pruning, fire control, weed and pest control, reseeding and timely repairs. The degree of maintenance depends upon the category of the vegetation and land; i.e. improved, semi-improved and unimproved grounds.

A. Grass shall be mowed when it attains the height of 6 inches. The grass and other volunteer growth shall be mowed to a height of 3 to 4 inches.

Hand mowing methods and light equipment, in areas where the use of heavy equipment might be injurious to the turf or soil, may be required. Where the cuttings resulting from the mowing operation are excessive, the cuttings shall be removed.

B. Fertilizer should be applied as needed to maintain a dense stand of desirable species. Frequently mowed areas and those on sandy soils will require more fertilization.

C. Lime requirement should be determined by soil testing every 2 or 3 years. Fertilization increases the need for liming.

D. Weed invasion may result from abusive mowing and inadequate fertilization and liming. Brush invasion is a common consequence of lack of mowing. The amount of weeds or brush that can be tolerated in any protective planting depends upon the land category and its intended use. Drainage ways are subject to rapid infestation by weeds and woody plants. These should be controlled if they reduce drainage way efficiency to the point of jeopardizing the road or its appurtenances or constitute a hazard or nuisance. Control of weeds or brush is accomplished by using herbicides or mechanical methods.

E. Pest and disease controls are more necessary on improved areas than on unimproved areas.

F. Fire hazard is greater where dry vegetation has accumulated. The taller the vegetation, the greater the hazard.

Definition

A non-vegetative woven mat fastened to exposed soil.

Purpose

Topsoil stabilization matting is used as a mechanical aid to protect the soil from erosion during the critical period of vegetative establishment. It is easier to lay and hold in place against wind. It has the tensile strength and weight to resist water flow and erosion.

Where Applicable

1. All swales in medians and sidewalk areas having a profile of 1 1/2% or steeper. Double the width for a distance of 50 feet away from the inlet. The single width should terminate 25 feet away from the upgrade inlet when a berm is constructed to retain the water at the inlet. If there is a danger of the water running past the inlet, the matting should be laid from inlet to inlet. Wide flat cross section medians sometimes require the use of two or more overlapping strips of matting to handle the volume of water properly, especially when roadways are designed on separate profiles, one higher than the other.
2. Long runs with grades of 1 1/2% or steeper to inlets in islands within interchanges.
3. Ditches in which sod and sometimes concrete would have pre

viously been specified.

4. Intercepting ditches at the end of high cut slopes.

Before the matting is placed in position the soil must be smooth, soft and free of depressions, clods, mounds, stones, or other debris which will prevent the matting from making complete contact with the soil. After the soil has been properly shaped, fertilized and seeded, the matting shall be laid out flat, and anchored securely with staples, so that the matting will be in contact with the soil at points.

Where soil stabilization matting is required in swales of medians, the matting may be installed in multiple widths.

When jute matting is being laid, the higher end shall be turned under 6 inches and buried in a vertical position.

Where strips of jute matting are laid end to end, the adjoining ends shall be laid so that the uphill strip overlaps the downhill strip. The upper end of each downhill strip shall be buried 6 inches deep in vertical position with the uphill strip overlapping for a distance of 6 inches to form a smooth shingle-like effect.

When adjoining rolls of jute matting are laid parallel to one another, the matting shall overlap from 3 to 6 inches.

When excelsior matting is being laid, the material shall be unrolled in the direction of the flow of water.

Where strips of excelsior matting are laid end to end, the adjoining ends shall be butted snugly.

When adjoining rolls of excelsior matting are laid parallel to one another, the matting shall be butted snugly.

Bulging seams in either matting material shall be cut and joints formed as described above.

Staples shall be placed along the outer edges of the matting and in a parallel row down the center of the strip. Staples shall be spaced 24 to 26 inches apart in the rows, except along overlapping edges where they shall be 12 to 13 inches apart. Staples shall be driven at an angle of approximately 30 degrees from horizontal.

In addition to the above requirements, staples shall be placed 12 inches apart across the matting at 50 foot intervals and at critical locations such as at inlets, check slots (if required) and overlapping joints and ends. The staples shall be driven flush with the surface of the matting and care shall be taken so as not to form depressions or bulges in the surface of the matting.

If any staples become loosened or raised, or if any matting becomes loose, torn or undermined, satisfactory repairs shall be made immediately.

Topsoil Stabilization Matting

Soil stabilization matting may be either jute or excelsior mat conforming to the requirements specified below:

Jute mat shall be cloth of a uniform plain weave of undyed and unbleached single jute yarn, 48 inches in width plus or minus 1 inch and

weighing an average of 1.2 pounds per linear yard of cloth with a tolerance of plus or minus 5 percent, with approximately 78 warp ends per width of cloth and 41 weft ends per linear yard of cloth. The yarn shall be of a loosely twisted construction having an average twist of not less than 1.6 turns per inch and shall not vary in thickness by more than one half its normal diameter.

Excelsior mat shall be wood excelsior, 48 inches in width plus or minus 1 inch and weighing 0.8 pounds per square yard plus or minus 10 percent. The excelsior material shall be covered with a netting to facilitate handling and to increase strength.

Staples

Staples for anchoring soil stabilization matting shall be made of 12 inch lengths of No. 8 plain iron wire.

Topsoil Stabilization Matting

Figure 1.9-1

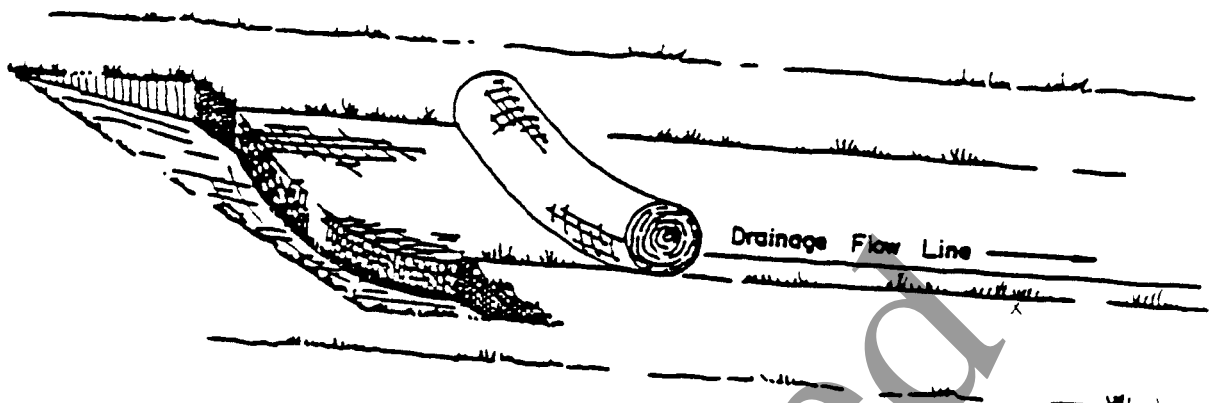

Bury top end of matting in a 6" trench.
Tamp trench full of soil.

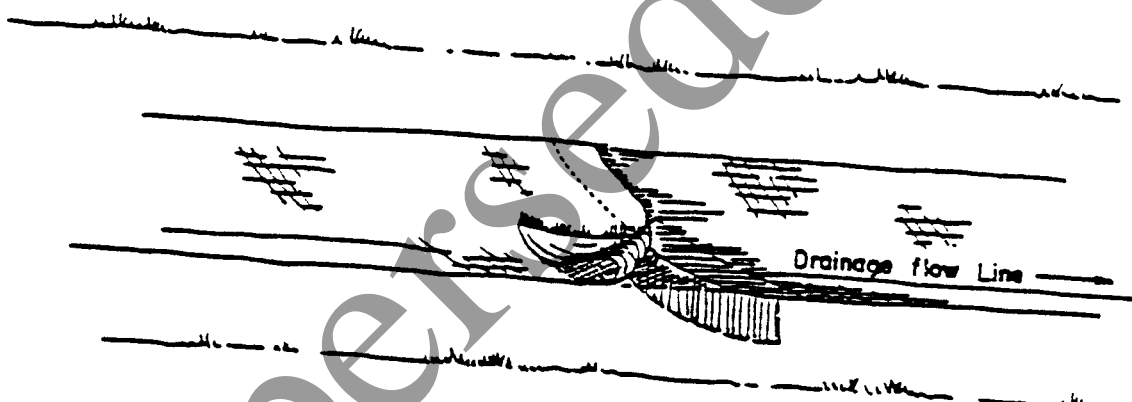

Uphill section overlaps lower section by 6".
Bury top end as per above detail.

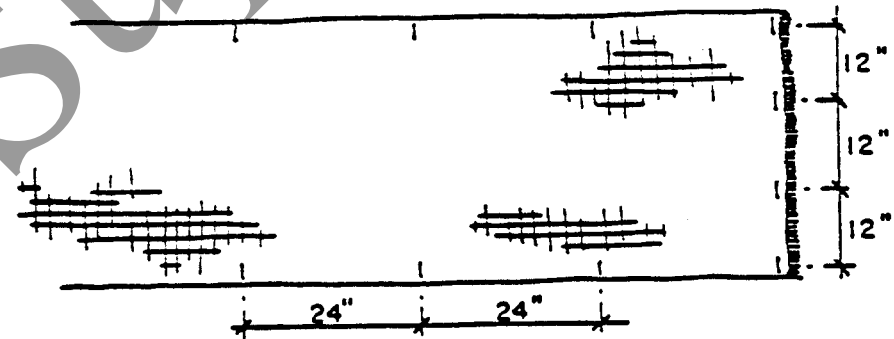

Secure with staples spaced 24" apart along the sides and 12" apart across the width at 50' intervals and the ends

Topsoil Stabilization Matting
Figure 1.9-2

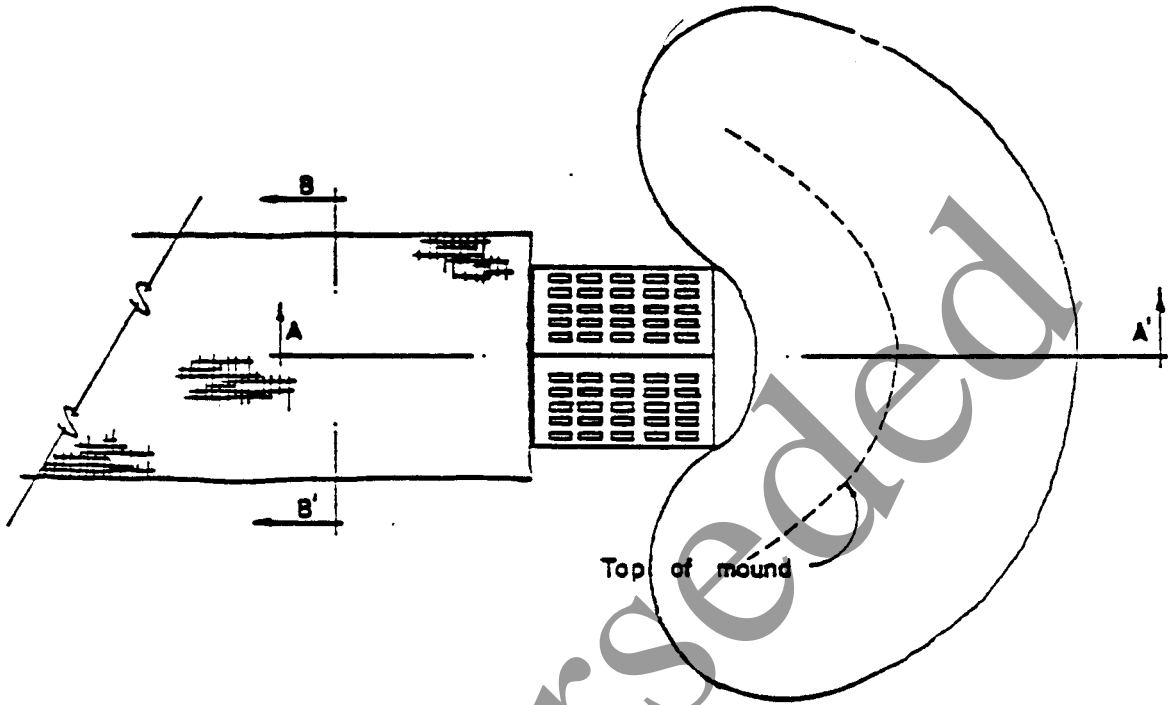

PLAN : SOIL STABILIZATION MATTING, INLET & MOUND
scale : 1/4" = 1'-0"

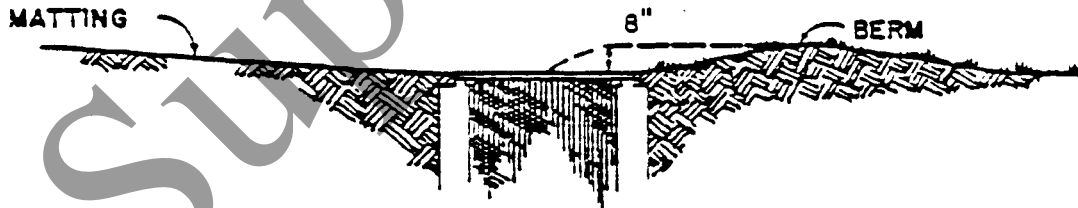

SECTION A - A'
scale : 1/4" = 1'-0"

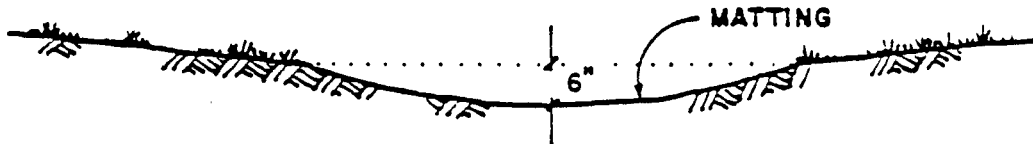

SECTION B - B'
scale : 1/2" = 1'-0"

SLOPE BOARDSDefinition

A 1" x 6" board placed in the slope to prevent soil erosion.

Purpose

To prevent erosion until a permanent vegetative cover can be established.

Where Applicable

On slopes 2:1 or steeper over eight (8) feet in height.

Methods and Materials

Slope boards shall be placed over the entire area of slopes more than 8 feet high, measured vertically and sloping 2:1 or steeper.

Slope boards shall be held firmly in place by being nailed to the 4 inch face of the stakes. The stakes shall be spaced not more than 3 feet apart O.C. and driven into the ground vertically so the top of the stake is flush with, or not more than 1/2 inch below, the top edge of the board.

On slopes which would normally require slope boards, but upon which said slope boards cannot be installed except with extreme difficulty because of underlying shale or rock, the slope boards shall be eliminated and the topsoil spread in a uniform layer that will produce a 2 inch compacted thickness.

Slope Boards

Slope boards shall be 1 inch by 6 inch boards, nominal size lumber, of sound wood with no defect which can impair their usefulness.

Stakes

Slope board stakes shall be 2 inches by 4 inches, nominal size lumber with a minimum length of 24 inches, of sound unsplit wood with no defects that may impair their usefulness, the upper 6 inches of the stake shall be full width to provide the maximum nailing surface.

Superseded

SLOPE BOARDS

Figure 1.10-1

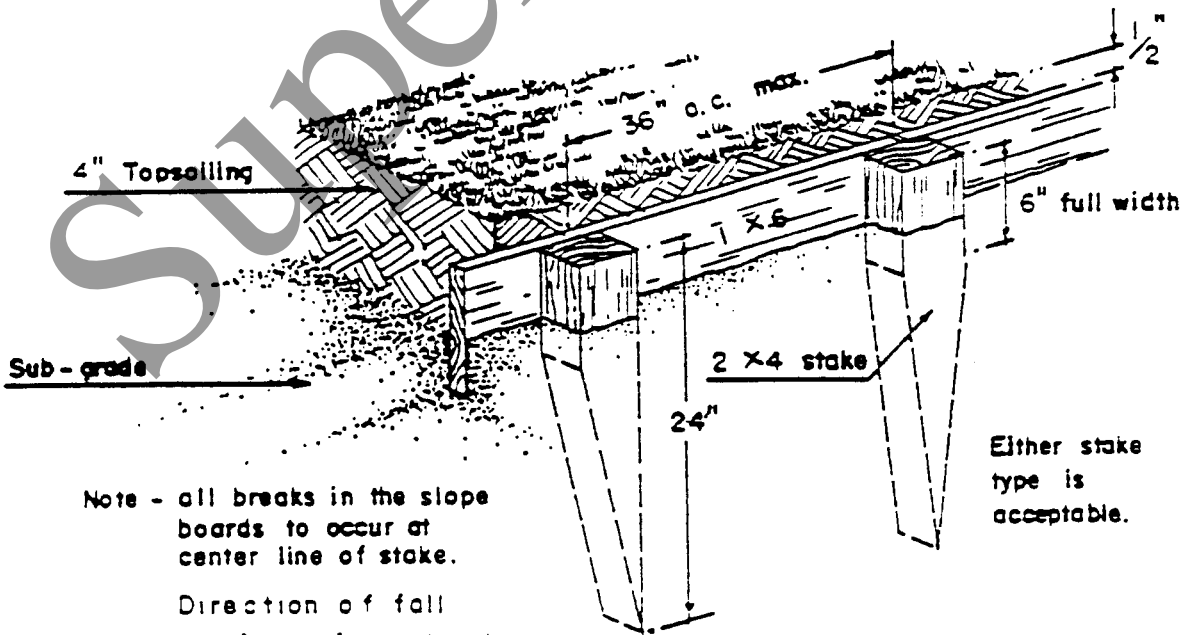
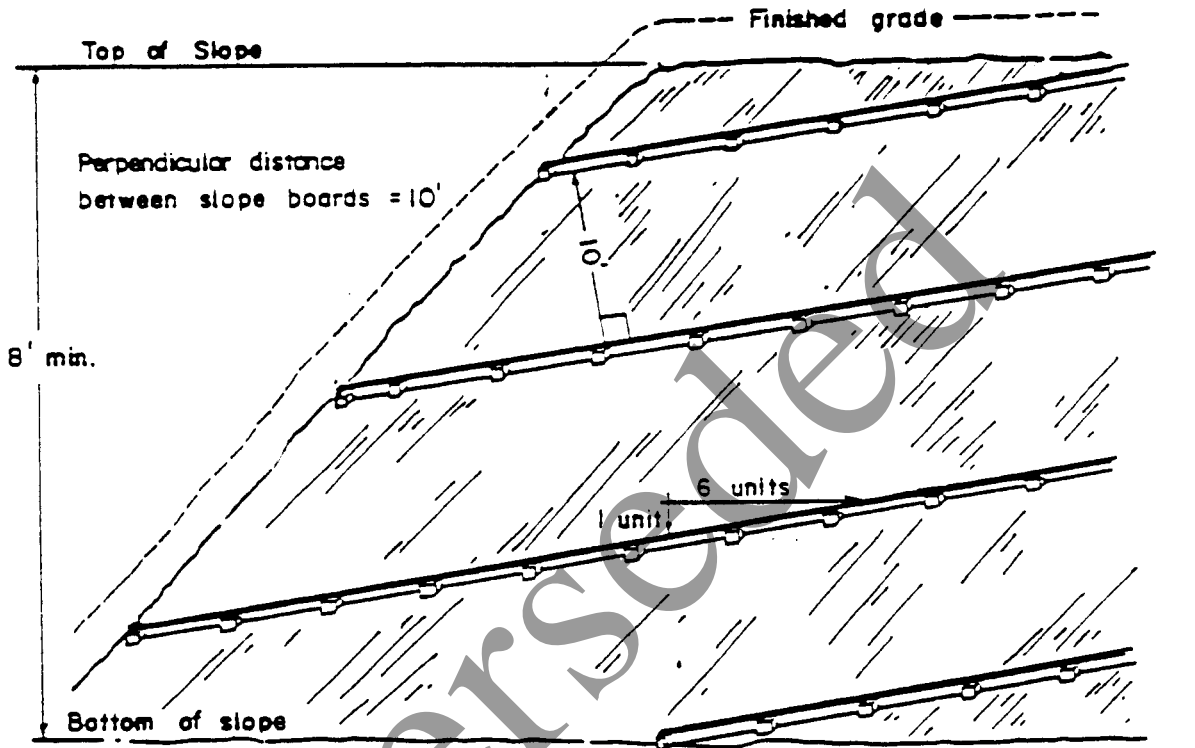

Note - all breaks in the slope boards to occur at center line of stake.

- Direction of fall
1. Away from structures
 2. In direction of downgrade of adjacent Roadway

Either stake type is acceptable.

Superseded

Definition

Preparing a seed bed from existing soil.

Purpose

To provide a seed bed for permanent vegetation in areas that have not been regraded.

Where Applicable

On existing soil where natural vegetation is not providing adequate vegetative cover to prevent soil erosion; i.e. where topsoil has been stored, or where a different type of vegetative cover is desired from the existing condition.

The surface of the existing soil to be prepared shall first be cleared of all stumps, brush, weeds and debris. It shall next be cultivated to a depth of 3 to 4 inches to prepare a seed bed. The entire area shall then be brought to a smooth grade, free from any depressions that would collect water. If necessary, additional topsoil shall be used to fill small objectionable depressions. Where depressions exceed 8 inches in depth, subsoil shall be added and covered with 4 inches of topsoil which shall be graded to provide a satisfactory surface contour.

All waste material and debris resulting from preparation of existing soil shall be disposed.

Topsoil

Topsoil shall conform to the requirements as specified under the standards for Topsoiling.

Superseded

STANDARD
FOR
LAND GRADING

Definition

Reshaping the ground surface by grading to planned grades which are determined by topographic survey and layout.

Purpose

The practice is for one or more of the following: Provide more suitable sites for land development; improve surface drainage and, control erosion.

Conditions Where Practice Applies

This practice is applicable where grading to planned elevations is practical and it is determined that grading is needed. Grading that involves the disturbance of vegetation over large areas shall be avoided. It may be necessary to provide for temporary stabilization of large areas.

Planning Criteria

The grading plan and installation shall be based upon adequate topographic surveys and investigations. The plan is to show the location, slope, cut, fill, and finish elevation of the surfaces to be graded. The plan should also include auxiliary practices for safe disposal of runoff water, slope stabilization, erosion control, and drainage. Facilities such as waterways, ditches, diversions, grade stabilization structures, retaining walls, and subsurface drains should be included where necessary.

Erosion control measures shall be designed and installed in accordance with the applicable standard contained herein.

The development and establishment of the plan shall include the following:

1. The cut face of earth excavations and fills shall be no steeper than the safe angle of repose for the materials encountered and flat enough for proper maintenance.
2. The permanently exposed faces of earth cuts and fills shall be vegetated or otherwise protected from erosion.
3. Provisions shall be made to safely conduct surface water to storm drains or suitable water courses and to prevent surface runoff from damaging cut faces and fill slopes.
4. Subsurface drainage is to be provided in areas having a high water table, to intercept seepage that would adversely affect slope stability, building foundations, or create undesirable wetness. See Standard for Subsurface Drainage (p. 2-8-1).

5. Adjoining property shall be protected from excavation and filling operations.
6. Fill shall not be placed adjacent to the bank of a stream or channel, unless provisions are made to protect the hydraulic, biological, aesthetic, and other environmental functions of the stream.

Installation Requirements

Timber, logs, brush, rubbish, rocks, stumps, and vegetative matter which will interfere with the grading operation or affect the planned stability or fill areas shall be removed and disposed of according to the plan.

Topsoil is to be stripped and stockpiled in amounts necessary to complete finish grading of all exposed areas requiring topsoil. See Standard for Topsoiling (p. 1-5-1).

Fill material is to be free of brush, rubbish, timber, logs, vegetative matter and stumps in amounts that will be detrimental to constructing stable fills.

All fills shall be compacted sufficiently for their intended purpose and as required to reduce slipping, erosion, or excessive saturation.

All disturbed areas shall be left with a neat and finished appearance and shall be protected from erosion. See Vegetative Standards (p. 1-1-1 to 1-5-2, 1-8-1 to 1-11-2.)

Trees to be retained shall be protected if necessary in accordance with the Standard for Tree Protection During Construction (p. 1-7-1).

STANDARD
FOR
DIVERSION

Definition

A channel with a supporting ridge on the lower side constructed across the slope.

Scope

This standard covers the installation of diversions with drainage areas up to 100 acres.

Temporary

Diversions installed as an interim measure to protect or facilitate some phase of construction. They usually have a life expectancy of one year or less. The failure hazard is low.

Permanent

Diversions installed as an integral part of an overall water management and disposal system and to remain for protection of property.

Purpose

The purpose of this practice is to divert water from areas where it is in excess to sites where it can be used or disposed of safely.

Conditions Where Practice Applies

This practice applies to sites where runoff is damaging: (1) low lying areas, (2) cut or fill slopes or steeply sloping land, (3) critical sediment source areas in construction sites, (4) buildings, residences, and streets, and (5) active gullies or other erodible areas.

Permanent diversions are not applicable below high sediment producing areas unless land treatment practices or structural measures, designed to prevent damaging accumulations of sediment in the channels, are installed with or before the diversions.

Design Criteria

Capacity and Freeboard

Peak discharge values shall be determined by the following:

1. Rational Method - for peak discharge of uniform drainage areas as outlined in Technical Manual for Stream Encroachment, Trenton, N.J., Bureau of Flood Plain Management, August 1984.

2. SCS Technical Release No. 55.

The minimum size shall be that required to confine the peak runoff from the design storm plus required freeboard. The design storm and freeboard shall comply with the following table:

Table 2.2.1

DIVERSION TYPE	TYPICAL AREA OF PROTECTION	DESIGN STORM FREQUENCY	FREEBOARD REQUIRED
Temporary	Construction Areas (structures, roads, pipelines, etc.)	2 years	0.0
	Building Sites	5 years	0.0

Table 2.2.2

DIVERSION TYPE	TYPICAL AREA OF PROTECTION	DESIGN STORM FREQUENCY	FREEBOARD REQUIRED
Permanent	Agricultural Land	25 years	0.3 ft.
	Urban Land Areas, Play Fields, Recreation Areas, Agricultural Buildings, etc.	25 years	0.3 ft.
	Homes, schools, industrial buildings, etc.	50 years	0.5 ft.

Small Diversions

1. Where the diversion channel grade is between 0.25% and 5%, a permanent vegetative cover is planned and the design flow is equal to or less than given below, the dimensions given below for a parabolic channel may be used instead of preparing an individual design for the diversion.

Table 2.2.3

CHANNEL DIMENSIONS		
Q (cfs)	TOP WIDTH (ft.)	DEPTH (ft.)
5	12	1.9
10	22	1.9

The depth given above includes 0.3 ft. freeboard and 0.1 ft. settlement. Side slopes shall be 3:1 or flatter, and the ridge top width shall be 4 ft. or wider.

- Where the diversion will be a temporary diversion to direct water off a graded right of way onto stable areas, and the only area draining toward the diversion is the right of way; the following spacings, and the size given above for 5 cfs may be used instead of preparing individual designs for each diversion.

Table 2.2.4

ROAD GRADE (percent)	APPROXIMATE DISTANCE BETWEEN DIVERSIONS (ft.)
1	400
2	245
5	125
10	78
15	58
20	47
25	40
30	35

Velocity

The maximum permissible velocity for design flow will be determined by the most erodible soil texture exposed and the type of vegetation expected and maintained in the channel. The following table will be used in selecting maximum permissible velocities:

Table 2.2.5

SOIL TEXTURE	MAXIMUM PERMISSIBLE† VELOCITY (ft./sec.)		
	CHANNEL VEGETATION		
	Non-Veg.*	Veg.**	Sod***
Sand	1.75	2.0	3.0
Silt loam, sandy loam, loamy sand, loam, and muck	2.0	2.0	3.0
Silty clay loam, sandy clay loam	2.0	2.5	4.0
Clay, clay loam, sandy clay, silty clay	2.5	3.0	5.0

†Maximum Permissible Velocities are based on flow of clear water.

*Temporary Diversions

**Vegetated Channels - The minimum capacity and maximum velocity shall be determined by using the appropriate vegetative retardance factors listed below. See Appendix A2 for examples and charts for use in design. Maximum permissible velocities for vegetated channels may be increased by 3 ft./sec. except for sands for sections where erosion control mat is installed according to manufacturer's recommendations. Erosion control mat is defined as a flexible mat of synthetic monofilaments bonded together to form a three dimensional web, highly resistant to environmental and chemical degradation.

***On well to excessively drained soils, most cool season sod types will not survive without continued irrigation. Placement of sod in such areas must be approved by the District.

Table 2.2.6

VEGETATIVE RETARDANCE FACTORS	
For Determining Minimum Capacity	For Determining Maximum Allowable Velocity
D	E

Tables to select channel dimensions are available in Chapters 7 and 9, Ref. #1.

Bare Channels - The minimum capacity and maximum velocity shall be determined by using Manning's formula with an "n" value of 0.025.

Cross Section

The shape of the channel cross section shall be such that the diversion can be properly maintained with modern equipment. The channel may be parabolic, vee-shaped, or trapezoidal.

The side slopes for permanent diversions shall not be steeper than 3:1 for maintenance purposes, and preferably 4:1. Where frequent crossings are expected, slopes should be flatter. The back slope of the ridge is not to be steeper than 3:1 and preferably 4:1. The ridge shall include a settlement factor equal to 5 percent of the height. The minimum top width of the diversion ridge after settlement is to be 4.0 feet at the design water elevation.

In determining the cross section for temporary diversions, consideration should be given to soil type, frequency of operation, and type of equipment that is anticipated to be crossing the diversion. In no case shall slopes be steeper than 1 1/2:1.

The top of the constructed ridge shall not be lower at any point than the design elevation plus the specified overfill for settlement.

Location

Diversion location shall be determined by outlet conditions, topography, land use, soil type, and length of slope. Consideration must be given to the effects caused by changing natural water courses and putting additional flow into a water course.

Grade

Channel grade may be uniform or variable. Uniform grades are normally better. The allowable velocity for soil type and vegetative cover will determine maximum grade. Diversions with blocked ends may be used provided adequate pipe outlets are provided.

Profile(s) and cross-section(s) of all channel diversions shall be submitted on the Soil Erosion and Sedimentation Control Plan.

Protection Against Sedimentation

When the movement of sediment into the diversion channel is a significant problem:

1. Land treatment or structural measures shall be installed to stabilize the source of sediment, or trap the sediment.
2. If it is not possible to stabilize or trap the sediment, a filter strip of close growing grass shall be maintained above the diversion channel. The filter strip width measured from the center of the channel shall be at least one-half the channel top width plus 15 feet.

Outlet

Each diversion must have an adequate, stable outlet. The outlet may be: a grassed, stone centered, or lined waterway; a vegetated or paved area; a grade stabilization structure; a storm sewer; a stable watercourse; a tile outlet; or open channel.

The outlet, in all cases, must be stable and convey water to a disposal point where damage will not result. Constructed vegetative outlets must be established prior to diversion construction.

Temporary Stone Outlet Structure

A temporary stone outlet structure for a diversion may be used only where the contributing watershed is less than five acres. The minimum length, in feet, of the crest of the stone outlet structure shall be equal to six times the number of acres of the contributing drainage area. The crest of the stone outlet structure shall be level and at least six inches lower than the lowest elevation of the top of the diversion. The stone shall be crushed stone and be 4" to 8" in diameter except for a one-foot thick blanket of 2" diameter stone on the upstream face.

The temporary stone outlet structure shall be located so as to discharge onto an already stabilized area or into a stable watercourse. The stone structure shall be embedded into the soil a minimum of four inches.

Permanent Cover and Erosion Protection

A permanent vegetative cover shall be established on all diversions in accordance with the Standard for Permanent Vegetative Cover for Soil Stabilization, p. 1-2-1 or Standard for Permanent Stabilization with Sod, p. 1-4-1. Where the season and other conditions may not be suitable for growing permanent erosion resistant cover, erosion protection will be provided in accordance with the Standard for Temporary Vegetative Cover for Soil Stabilization, p. 1-1-1 or Standard for Stabilization with Mulch Only, p. 1-3-1.

Diversions that are not designed to have a permanent vegetative cover shall be designed for bare channel velocities and with flat side slopes to prevent channel and side slope erosion. Diversions that are designed to have a permanent vegetative cover shall be seeded from the toe of the backslope to the upstream side of the designed channel width, plus any required filter strip. Other areas disturbed by diversion construction shall also be seeded.

Installation Requirements

All trees, brush, stumps, or other objectionable material shall be removed so they will not interfere with construction or proper functioning of the diversion. All ditches or gullies which must be crossed, will be filled and compacted prior to, or as part of the construction. Fence rows and other obstructions that will interfere with construction or the successful operation of the diversion are to be removed.

Vegetation is to be removed and the base for the ridge thoroughly disked before placement of fill.

The minimum constructed cross-section is to meet the design requirements.

The top of the constructed ridge is not to be lower than the design elevation plus the specified amount for settlement.

Fertilizing, seeding, and mulching shall conform to the requirements in the Standard for Permanent Vegetative Cover for Soil Stabilization, p. 1-2-1.

If there is no sediment protection provided on temporary diversions, it should be anticipated that periodic cleanout may be required.

Construction operations shall be carried out in such a manner that erosion and air and water pollution will be minimized. State and local laws shall be complied with.

FIGURE 2.2-1

SMALL DIVERSIONS FOR GRADED RIGHT-OF-WAY

For use on graded right-of-way, if the only drainage area is the right-of-way

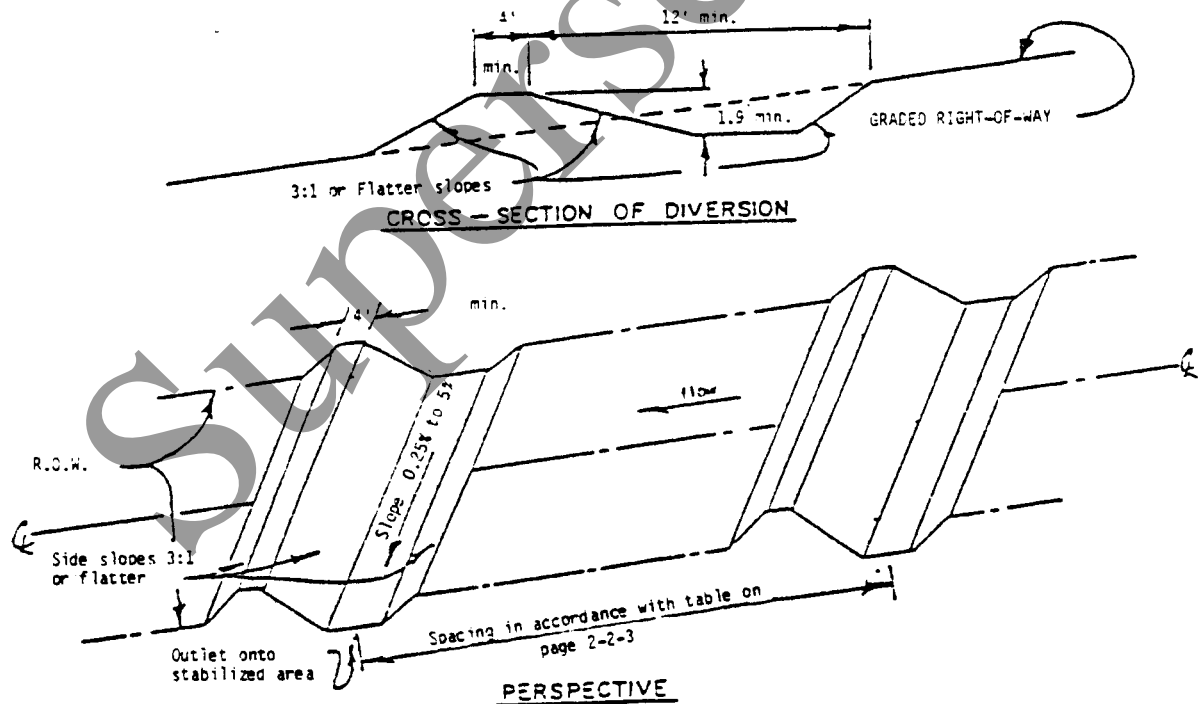

DESIGN CRITERIA

Top width - 4 ft. min.

Height - 1.9 ft. min. (height measured from the upslope toe to top of the dike).

Side slopes - 3:1 or flatter (flat enough to allow construction traffic to cross if desired.)

Grade - 0.25% to 5%.

Spacing - according to Table on page 2.2.3.

GENERAL NOTES

1. Top width may be wider and side slopes may be flatter, if desired.
2. Diverted runoff shall outlet onto an undisturbed stable area, or onto an area that has been stabilized.
3. Periodic inspection and required maintenance must be provided.

Superseded

STANDARD
FOR
GRASSED WATERWAY

Definition

A natural or constructed watercourse shaped or graded in earth materials and stabilized with suitable vegetation for the safe conveyance of runoff water.

Purpose

To provide for the conveyance of excess surface water without damage by erosion or flooding.

Conditions Where Practice Applies

This practice applies to sites with drainage areas less than 200 acres where concentrated runoff requires vegetative protection or stone center lining to control erosion. Slope of waterway must be less than 10%. Some of the other practices that may be required with this practice are: (1) grade control structures, (2) subsurface drainage to permit the growth of suitable vegetation and to eliminate wet spots, (3) a section stabilized with stone or other material within the waterway, or (4) buried storm drain to handle frequently occurring storm runoff, base flow, or snowmelt.

Design Criteria

Capacity

Peak discharge values shall be determined by the following:

1. Rational Method - for peak discharge of uniform drainage areas as outlined in Technical Manual for Stream Encroachment, Trenton, N.J., Bureau of Flood Plain Management, August 1984.
2. SCS Technical Release No. 55.

The minimum capacity shall be that required to convey the peak runoff expected from a 10-year frequency storm.

Velocity

The maximum permissible velocity for design flow will be determined by the most erodible soil texture exposed and the type of vegetation expected and maintained in the channel. The following table will be used in selecting the maximum permissible velocities:

Table 2.3.1

SOIL TEXTURE	MAXIMUM PERMISSIBLE VELOCITY† (ft./sec.)	
	CHANNEL VEGETATION	
	Vegetated*	Sod**
Sand, silt loam, sandy loam, loamy sand, loam, and muck	2.0	3.0
Silty clay loam, sandy clay loam	2.5	4.0
Clay, clay loam, sandy clay, silty clay	3.0	5.0

†Maximum Permissible Velocities are based on flow of clear water.

*Maximum permissible velocities for vegetated channels may be increased by 3 ft./sec. except for sands for sections where erosion control mat is installed according to manufacturer's recommendations. Erosion control mat is defined as a flexible mat of synthetic monofilaments bonded together to form a three dimensional web, highly resistant to environmental and chemical degradation.

**On well to excessively drained soils, most cool season sod types will not survive without continued irrigation. Placement of sod in such areas must be approved by the District.

Vegetative Retardance Factors and Manning's "n" Value

The minimum capacity and maximum velocity shall be determined by using the appropriate vegetative retardance factors listed below. See Appendix A2 for example and charts for use in design.

Table 2.3.2

VEGETATIVE RETARDANCE FACTORS	
For Determining Minimum Capacity	For Determining Maximum Allowable Velocity
D	E

Tables to select channel dimensions are available in Chapter 7, Ref. #1.

Dimensions

The dimensions of the waterway will be based on: (1) the minimum required for capacity, the channel slope, the maximum permissible velocity, the vegetation, the soil; (2) ease of crossing and maintenance; and (3) site conditions such as water table, depth to rock, or possible sinkholes.

The minimum top width of a waterway will be 10 feet. The maximum design top width shall not exceed 50 feet.

The cross section may be parabolic, vee-shaped, or trapezoidal.

Cross-section(s) and profile(s) of all grassed waterways shall be submitted on the Soil Erosion and Sedimentation Control Plan.

Drainage

In areas with low flow, high water table, or seepage problems, underdrains, stone centers, or other subsurface drainage methods are to be provided. A minimum drainage coefficient of 1/2 inch in 24 hours is to be used for underdrain design. An open joint storm drain may be used to serve the same purpose and also handle frequently occurring storm runoff, base flow, or snowmelt. The storm drain shall be designed to handle base flow, snowmelt, or the runoff from at least a one-year frequency storm, whichever is greater.

Outlet

The outlet must handle the design flow without flood damage. The outlet must be stable for the 10-year storm.

Vegetation

Permanent Cover

A permanent vegetative cover shall be established on all grassed waterways in accordance with the Standard for Permanent Vegetative Cover for Soil Stabilization, p. 1-2-1 or Standard for Permanent Stabilization with Sod, p. 1-4-1. Where the season and other conditions may not be suitable for growing permanent erosion resistant cover, erosion protection will be provided in accordance with the Standard for Temporary Vegetative Cover for Soil Stabilization, p. 1-1-1 or Standard for Stabilization for Mulch Only, p. 1-3-1. The seeding will extend to at least the design top width.

Installation Requirements

Construction

Trees, brush, stumps, and other material in objectionable amounts are to be cleared and disposed of so as not to interfere with construction or proper functioning of the waterway.

Fills are to be compacted as needed to prevent unequal settlement that will cause damage in the completed waterway.

Vegetative Lining

Waterways or outlets shall be protected against erosion by vegetative means as soon after construction as practical and before diversions or other channels are outletted into them. Consideration should be given to the use of jute matting, excelsior matting (see Standard for Topsoil Stabilization Matting, p.1-9-1,) or sodding channels to provide erosion protection as soon after construction as possible.

Seeding, fertilizing, mulching, and sodding shall be in accordance with the applicable standards.

Superseded

STANDARD
FOR
SEDIMENT BASIN

Definition

A barrier, dam, excavated pit, or dugout constructed across a waterway or at other suitable locations to intercept and retain sediment.

Basins created by construction of dams or barriers are referred to as "Embankment Sediment Basins" and those constructed by excavation as "Excavated Sediment Basins." Basins resulting from both excavation and embankment construction are classified as "Embankment Sediment Basins" where the depth of water impounded against the embankment at emergency spillway elevation is 3 feet or more.

Scope

The standard covers the installation of sediment basins on sites where:

1. Failure of the sediment basin should not, within reasonable expectations, result in loss of life.
2. Failure of the sediment basin would not result in damage to homes, commercial or industrial buildings, main highways, or railroads; or interrupt the use or service of public utilities.
3. The drainage area is 320 acres or less.
4. The effective height of the dam is 20 feet or less. The effective height of the dam is defined as the difference in elevation in feet between the emergency spillway crest and the lowest point in the cross section taken along the centerline of the dam. If there is no emergency spillway, the top of the dam becomes the upper limit.

Sediment basins that are not within the above scope shall be designed to meet the criteria in "Earth Dams and Reservoirs, Technical Release 60" (TR60) by the Soil Conservation Service, U.S. Department of Agriculture.

In addition to the criteria set forth in this Standard, the rules and regulations established by the New Jersey Department of Environmental Protection, Division of Water Resources, for the construction and inspection of dams or for stream encroachments, shall apply.

Purpose

To preserve the capacity of reservoirs, ditches, canals, diversions, storm sewers, waterways, and streams; to prevent undesirable deposition on bottom-lands and developed areas; to trap sediment originating from critically eroding areas and construction sites; and to reduce or abate pollu-

tion by providing basins for deposition and storage of silt, sand, gravel, and stone.

Conditions Where Practice Applies

This practice applies where physical conditions, land ownership, or construction operations preclude the treatment of the sediment source by the installation or erosion control measures to keep soil and other material in place, or a sediment basin offers the most practical solution to the problem.

Design Criteria

Sediment Basin Location

The basin shall be designed to accommodate the individual storm runoff and sediment accumulation from the basin's total drainage area.

The basin should be located as much as possible:

- a. To intercept only runoff from distributed areas.
- b. To minimize disturbance from its own construction.
- c. To obtain maximum storage benefit from the terrain.
- d. For ease of cleanout of the trapped sediment.
- e. To minimize interference with other construction activities and construction of utilities.

Sediment Basin Volume

The volume in the sediment basin below the crest elevation of the emergency spillway shall be the larger of:

1. The volume necessary to obtain 70% trap efficiency at the start of the basin's useful life, or
2.
 - a. The volume necessary to provide sediment storage capacity and provide for temporary stormwater runoff storage from a 2-year frequency, 24-hour duration, Type III storm, or
 - b. Use the modified rational method up to 20 acres, as described in Special Report 43 by the American Public Works Association, Practices in Detention of Urban Stormwater for a 2-year frequency storm.

Principal Spillway Crest Evaluation

The principal spillway crest elevation shall be the lower of one (1) foot below the emergency spillway crest elevation of the elevation that provides, between the crest of the principal spillway and the crest of the emergency spillway, the required temporary floodwater storage for a 2-year frequency, 24-hour duration, Type III storm.

Flood routing to determine the required temporary floodwater storage for a 2-year frequency, 24-hour duration, Type III storm shall be done using the approximate methods in the SCS "Engineering Field Manual," the approximate methods in the SCS "Urban Hydrology for Small Watersheds" (TR55), or other generally accepted methods of flood routing.

The modified rational method on a drainage basin up to 20 acres, as described in Special Report 43 by the American Public Works Association, Practices in Detention of Urban Stormwater, is also applicable.

Trap Efficiency

Trap efficiency is the amount in percent of the sediment delivered to the sediment basin that will remain in the basin. The sediment basin shall have adequate volume below the crest of the emergency spillway to have an actual trap efficiency of at least 70% at the start of its useful life using Curve 2-4-1 and with:

C = total capacity of the sediment basin up to the crest elevation of the emergency spillway in acre feet.

I = average annual surface runoff from Figure 2-4-1 converted to units of acre feet.

For a normally dry sediment basin, the actual trap efficiency is reduced 10% where the incoming sediment is predominately silt, clay, or fine grained. Therefore, enter Curve 2-4-1 with 80% trap efficiency to achieve 70% actual trap efficiency. For a normally dry sediment basin, the actual trap efficiency is reduced 5% where the incoming sediment is sand or coarse grained. Therefore, enter Curve 2-4-1 with 75% trap efficiency to achieve 70% actual trap efficiency.

Sediment Storage Capacity

The sediment storage capacity of a sediment basin shall equal the volume of sediment expected to be trapped at the site during the planned useful life of the sediment basin. Where it is determined that periodic removal of sediment is practicable, the sediment storage capacity may be proportionately reduced. Planned periodic removal of sediment shall not be more frequent than once a year. The capacity shall be determined by one of the following methods:

1. Provide 0.07 acre feet of sediment storage volume per acre of total drainage area per year of planned life.
2. Provide sediment storage based on the following formula and figures:

$$V = (DA) (A) (DR) (TE) (1/\gamma_s) (2,000 \text{ lbs./tons}) (1/43560 \text{ sq. ft./Ac.})$$

where:

V = the volume of sediment trapped in AC. ft./yr.
DA = the total drainage area in acres.

A = the average annual erosion in tons per acre per year using the values below for the listed land use

Table 2-4-1

LAND USE	AVERAGE ANNUAL EROSION
Wooded areas	0.2 ton/ac/yr
Developed urban areas, grassed areas, pastures, hay fields, abandoned fields with good cover	1.0 ton/ac/yr
Clean tilled cropland (corn, soybeans, etc.)	10 ton/ac/yr
Construction areas	50 ton/ac/yr

DR = the delivery ratio determined from Curve 2-4-2.

TE = the trap efficiency as determined above.

γ = the estimated sediment density in the sediment basin in lbs/cu. ft. (See Table 2-4-2).

γ_s = the submerged density in a wet sediment pool.

γ_a = the aerated density in a normally dry sediment pool.

TABLE 2-4-2

SOIL TEXTURE	γ_s Submerged (lbs./cu. ft.)	γ_a Aerated (lbs./cu. ft.)
Clay	40-60	60-80
Silt	55-75	75-85
Clay-silt mixtures (equal parts)	40-65	65-85
Sand-silt mixtures (equal parts)	75-95	95-100
Clay-silt-sand mixtures (equal parts)	50-80	80-100
Sand	85-100	85-100
Gravel	85-125	85-125
Poorly sorted sand and gravel	95-130	95-130

3. Provide sediment storage based on the same procedure as 2. above except determine (A) using the Universal Soil Loss Equation (Appendix A1) with on-site conditions.

Shape and Depth

The length, width, and depth are measured at the principal spillway crest elevation. The basin configuration shall be such that the effective flow length is equal to at least two times the effective flow width. This basin shape may be attained by selecting the basin site, by excavating the basin to the required shape or by the installation of one or more baffles.

The minimum width shall be:

$$W = 10 \sqrt{Q_5}$$

where:

W = the width in ft.

Q₅ = peak discharge from a 5 year frequency storm in cfs.

The average depth shall be at least 4 feet.

When downstream damage may be severe, the minimum width should be:

$$W = 10 \sqrt{Q_{25}}$$

where:

W = width in feet

Q₂₅ = peak discharge from a 25 year frequency storm in cfs.

The average depth shall be at least 4 feet.

Foundation Cutoff for Embankment Sediment Basin

A foundation cutoff constructed with relatively impermeable materials shall be provided for all embankments. The minimum depth of the cutoff shall be 3 feet. The cutoff trench, as a minimum, shall extend up both abutments to the emergency spillway crest elevation. The minimum bottom width shall be 4 feet, but wide enough to permit operation of compaction equipment. The side slopes shall be no steeper than 1:1. Compaction requirements shall be the same as those for the embankment. The trench shall be kept free from standing water during the back-filling operations.

Seepage Control

Seepage control is to be included if seepage may create swamping downstream; if needed to insure a stable embankment; or if special problems require drainage for a stable dam. Seepage control may be accomplished by foundation, abutment, or embankment drains, reservoir blanketing, or a combination of these and other measures.

Foundation

The area on which an embankment is to be placed shall consist of material that has sufficient bearing strength to support the embankment without excessive consolidation.

Earth Embankment

Top width - The minimum top widths of embankments are shown in Table 2-4-3. When the embankment top is to be used as a public road, the minimum width, guardrails, or other safety measures are to meet the requirements of the responsible road authority. The minimum top width will be increased as necessary to accommodate construction equipment.

TABLE 2-4-3

TOTAL HEIGHT OF EMBANKMENT (feet)	MINIMUM TOP WIDTH (feet)
<20	10
20-24	12

For dams which raise the water elevation five (5) feet or greater in height as defined in NJAC 7:20 the rules and regulations established by the New Jersey Department of Environmental Protection, Division of Water Resources, shall apply for all structural criteria. Flood Hazard Area Regulations NJAC 7:13-1.1 et. seq. may also apply.

Side Slopes - The combined upstream and downstream side slopes of the settled embankment shall not be less than five horizontal to one vertical (5:1) with neither slope steeper than 2:1. Slopes must be designed to be stable in all cases.

Freeboard - The minimum elevation of the top of the settled embankment shall be increased by the amount needed to insure that, after all settlement has taken place, the height of the dam will equal or exceed the design height. This increase shall not be less than 10% when compaction is by hauling equipment or 5% if compactors are used, except where detailed soil testing and laboratory analysis shows that a lesser amount is adequate.

Compaction - The compaction requirements shall be specified.

Embankments of Other than Earthfill

Sediment basins with effective heights of less than 5 feet may use materials other than earth for the embankment. These embankments shall be structurally sound, and have hydraulic characteristics that will safely handle the principal and emergency spillway design storm.

Principal Spillway

The minimum pipe size shall be 8 inches for corrugated or helical pipe and 6 inches for smooth wall pipe.

Pipe Conduits - Sediment basins shall have pipe conduits with required appurtenances except where a structural spillway is used.

1. The materials and installation for pipe conduits for excavated sediment basins shall meet the local municipality requirements for culverts or storm sewers.
2. Conduits for embankment sediment basins shall meet the following requirements:

- a. The pipe shall be capable of withstanding the external loading without yielding, buckling, or cracking.
- b. All joints shall be watertight.

Inlets for Pipe Conduits - The inlet shall be structurally sound and made from materials compatible with the pipe. The inlet shall be designed to prevent flotation. The inlets shall be designed to function satisfactorily for the full range of flow and hydraulic head anticipated. The inlet materials shall be subject to the same limitations and requirements as pipe conduits.

1. Watertight Riser - The riser shall be completely watertight except for the inlet at the top and one hole 4 inches or less in diameter to dewater the basin.
2. Dewatering the Sediment Basin - Sediment basins with a permanent pool of water trap sediment more effectively than basins that are normally dry and usually create less of a mosquito problem and safety hazard. Therefore, a sediment basin with a permanent pool is usually a better design than a normal dry sediment basin.

If a normally dry or partially dry sediment basin is planned, the basin shall be dewatered by a 4 inch diameter or smaller hole in the riser or by the use of subsurface drains or by a combination of these two methods.

If the sediment basin is dewatered by using a hole in the riser:

- a. The elevation of the hole shall be the elevation that results in 50% actual trap efficiency in the basin. The value for C used to determine the 50% actual trap efficiency is the capacity of the basin between the bottom of the hole and crest elevation of the emergency spillway.
- b. The sediment shall be removed from the basin when the sediment reaches the elevation of the bottom of the hole.

If the sediment basin is dewatered by using a subsurface drain, it shall be in accordance with the Subsurface Drain Standard.

Appendix A3 shows several methods for dewatering a sediment basin.

Pipe Drop Inlet - Where the pipe is designed for pressure flow:

1. The weir length shall be adequate to prime the pipe below the emergency spillway elevation.
2. For pipe on less than critical slope, the drop inlet shall be at least 2D deep, where D is the conduit diameter.
3. For pipe on critical slope or steeper, the drop inlet shall be at least 5D deep, where D is the conduit diameter.

Antivortex Devices - Sediment basins with the principal spillway designed for pressure flow are to have adequate antivortex devices.

Trash and Safety Guards - An appropriate guard shall be installed at the inlet. The guard shall prevent clogging of the pipe by trash and reduce the safety hazard to people. The guard shall be a type that will not plug with leaves, grass, or other debris.

Outlets for Conduits - The outlets shall be structurally sound and made from materials compatible with the conduit. The outlets shall be designed to function satisfactorily for the full range of flow and hydraulic head anticipated. Protection against scour at the discharge end of the spillway shall be provided. Measures may include an impact basin, conduit outlet protection, rock riprap, excavated plunge pools, or use of other generally accepted methods.

Antiseep Collars - Antiseep collars are not required for excavated sediment basins. Pipe conduits for embankment sediment basins shall be provided with antiseep collars.

The following criteria are to be used to determine the size and number of antiseep collars:

Let V = projection of the antiseep collar in feet

L = length in feet of the conduit within the zone of saturation, measured from the downstream size of the riser to the toe drain or point where phreatic line intercepts the conduit, whichever is shorter.

n = number of antiseep collars.

The ratio of the length of the line of seepage ($L + 2nV$) to L is to be not less than 1.15. Antiseep collars should be equally spaced along that part of the barrel within the saturated zone at distances of not more than 25 feet.

The antiseep collars and their connections to the pipe shall be watertight. The collar material shall be compatible with pipe materials.

Emergency Spillways

Emergency spillways are provided to convey large floods safely past sediment basins.

An emergency spillway must be provided for each sediment basin, unless the principal spillway is large enough to pass the routed emergency spillway design storm and the trash that comes to it without overtopping the dam. A closed conduit principal spillway having a conduit with a cross-sectional area of 3 square feet or more, an inlet which will not clog, and an elbow designed to facilitate the passage of trash is the minimum size and design that may be utilized without an emergency spillway.

1. Excavated Sediment Basins - Excavated sediment basins may utilize the natural ground or the fill for the emergency spillway if the downstream slope is 5 to 1 or flatter, has existing vegetation, or is immediately protected by sodding, rock riprap, asphalt lining, concrete lining, or other equally effective protection. The spillway shall meet the capacity requirement for embankment sediment basins.
2. Embankment Sediment Basins - Embankment sediment basins shall meet the following requirements:
 - a. Capacity - The minimum capacity of the emergency spillway shall be that required to pass the peak flow expected from a design storm of the frequency and duration shown in Table 2-4-4 less any reduction creditable to conduit discharge and detention storage.

When discharge of the principal spillway is considered in calculating outflow through the emergency spillway, the crest elevation of the inlet shall be such that full flow will be generated in the conduit before there is discharge through the emergency spillway. The emergency spillway shall safely pass the peak flow or the storm runoff shall be routed through the reservoir. If routed, the routing shall start with the water surface at the elevation of the crest of the principal spillway. The flood routing may be done using the approximate methods in the SCS Engineering Field Manual; the SCS Technical Release 55; the modified rational method up to 20 acres, as described in Special Report 43 by the American Public Works Association, Practices in Detention of Urban Stormwater; or other accepted methods of emergency spillway flood routing.

TABLE 2-4-4

MINIMUM DESIGN STORM

DRAINAGE AREA (acres)	FREQUENCY (years)	MINIMUM DURATION* (hours)
less than 20	10	24
21 - 49	25	24
over 49	100	24

*For use by SCS methods only.

- b. Velocity - Emergency spillways are to provide for passage of the design flow at a safe velocity to a point downstream where the dam will not be endangered. The maximum permissible velocity in the exit channel shall be 4 ft. per second for vegetated channels in soils with a plasticity index of 10 or less and 6 ft. per second

for vegetated channels in soil with a plasticity index greater than 10. For exit channels with erosion protection other than vegetation, the velocities shall be in the safe range for the type of protection used.

- c. Cross Sections - Emergency spillways shall be trapezoidal and will be located in undisturbed earth. The side slopes shall be 2 to 1 or flatter. The bottom width shall be 10 feet or wider. The embankment requirement determines elevation differences between crest of the emergency spillway and settled top of dam.
- d. Component Parts - Emergency spillways are open channels and consist of an inlet channel, control section, and an exit channel. The emergency spillway should be as long as possible to provide protection from breaching.
 - (1) Inlet channel - the inlet channel shall be level and straight for at least 20 feet upstream of the control section. Upstream of the level area, it may be graded back towards the pond to provide drainage. The alignment of the inlet channel may be curved upstream of the straight portion.
 - (2) Exit channel - The grade of the exit channel of a constructed spillway shall fall within the range established by discharge requirements and permissible velocities. The exit channel shall carry the design flow downstream to a point where the flow will not discharge on the toe of the dam. The design flow should be contained in the exit channel without the use of dikes. If a dike is necessary, it shall have 2:1 or flatter side slopes, 8 feet top width minimum, and be high enough to contain the design flow plus one foot of freeboard.

Structural Spillways Other Than Pipe

Structural spillways other than pipe will have structural designs based on sound engineering data with acceptable soil and hydrostatic loadings as determined on an individual site basis.

When used as a principal spillway, they shall pass the storm runoff from a 2 year, 24-hour duration storm without flow through the emergency spillway and shall not be damaged by the emergency spillway design storm. When used as an emergency spillway, they shall pass the storm runoff from the appropriate storm in Table 2-4-4.

Vegetation

The dam, emergency spillway, spill and borrow areas, and other disturbed areas above crest of the principal spillway shall be stabilized in accordance with the standards for temporary or permanent vegetative cover, whichever is applicable.

Disposal

The sediment basin plans shall indicate the method(s) of disposing of the sediment removed from the basin. The sediment shall be placed in such a manner that it will not erode from the site. The sediment shall not be deposited downstream from the basin or, in or adjacent to a stream or floodplain.

The plans shall also show the method of removal of the sediment basin after the drainage area is stabilized, and shall include the stabilizing of the sediment basin site. Water lying over the trapped sediment shall be removed from the basin by pumping, cutting the top of the riser, or other appropriate method prior to removing or breaching the embankment. Sediment shall not be allowed to flush into the stream or drainageway.

Safety

Sediment basins attract children and can be very dangerous. They should be fenced or otherwise made inaccessible to persons or animals unless deemed unnecessary due to the remoteness of the site or other circumstances. In any case, local ordinances and regulations regarding health and safety must be adhered to. This portion of the Standard is for guidance only.

Maintenance

The plans shall indicate who is responsible for operation and maintenance during the life of the sediment basin.

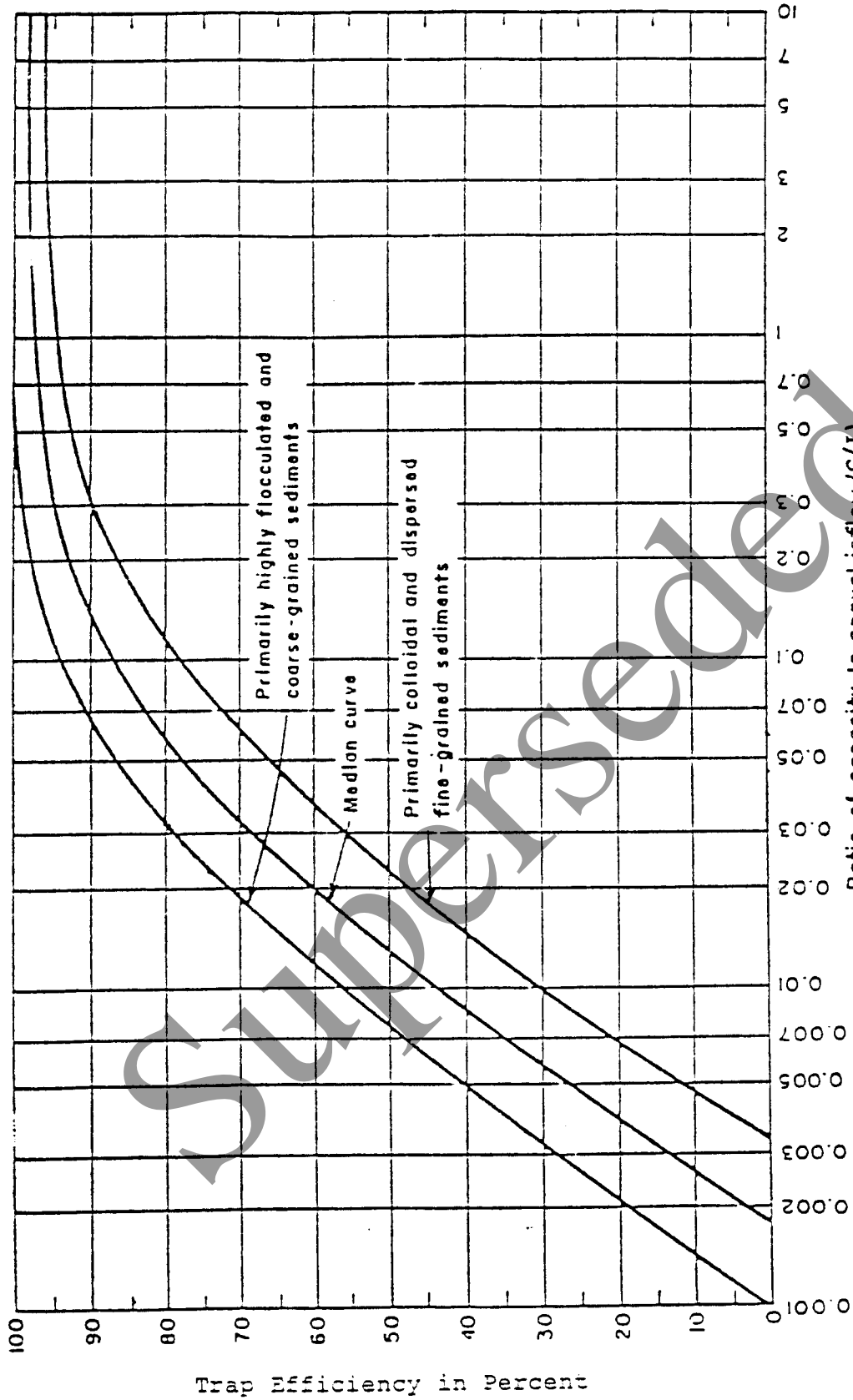

CURVE 2.4 -1

TRAP EFFICIENCY OF RESERVOIRS

Reference: Brune, Gunnar M., "Trap Efficiency of Reservoirs", Trans. AGU, Vol. 34, No.3, pp 407-418, June 1953.

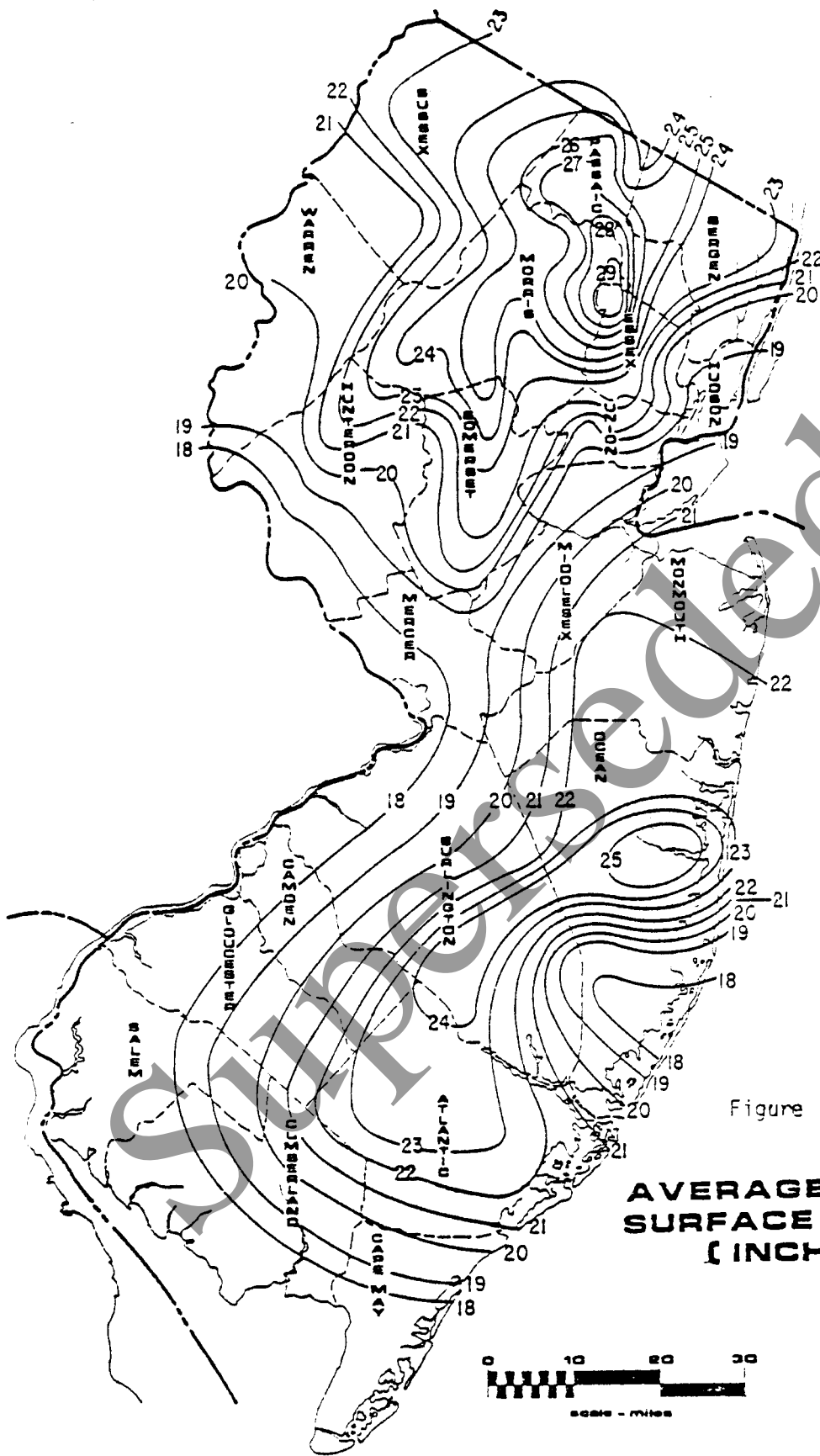

Figure 2.4-1

**AVERAGE ANNUAL
SURFACE RUNOFF
(INCHES)**

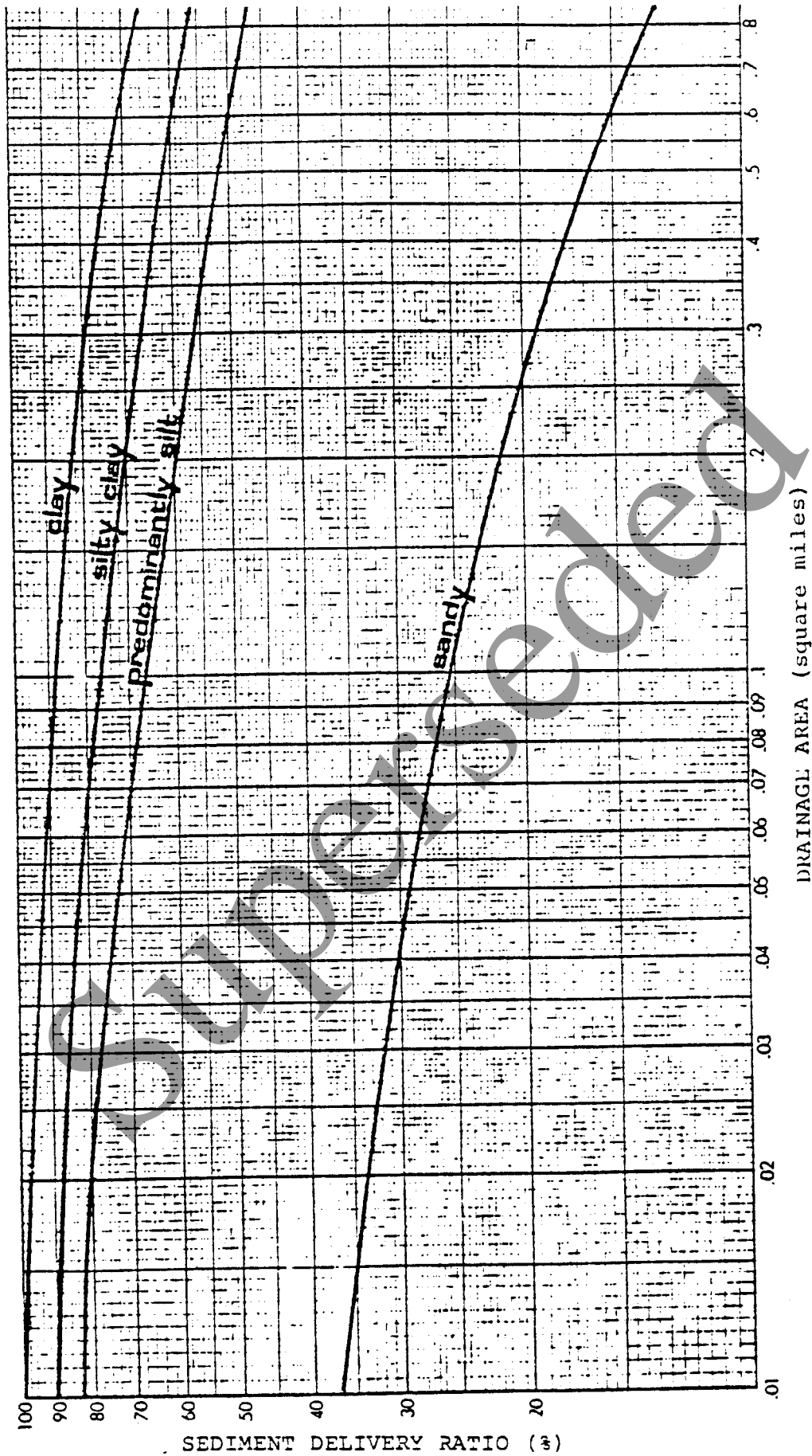

FIGURE 2.4-2
 SEDIMENT DELIVERY RATIO VS. DRAINAGE AREA

Superseded

STANDARD
FOR
SLOPE PROTECTION STRUCTURES

Definition

Structures to safely conduct surface runoff from the top of a slope to the bottom of the slope.

Purpose

The purpose of this practice is to convey storm runoff safely down existing slopes and cut and fill slopes to minimize erosion.

Conditions Where Practice Applies

Slope protection structures are to be used where concentrated water will cause excessive erosion on existing and/or recent cut and fill slopes. Temporary structures shall be left in place until adequate vegetation and the permanent drainage system have been installed. Permanent structures are part of the drainage system.

Design Criteria

Open Flumes

Flumes shall be adequately designed to convey runoff water concentrations safely down steep slopes based on a 10-year frequency storm, the rational method for uniform drainage area up to one-half of a square mile, or sized in accordance with the requirements of Tables 2-5-1 and 2-5-2.

Protection against scour at the discharge end of the open flume shall be provided in the form of an energy dissipator or other measures such as an SAF, rock riprap revetment, or plunge pool.

Recommended dimensions for flumes are defined as follows:

1. b - is the bottom width of the paved down slope section of a trapezoidal or rectangular flume. The minimum bottom widths and associated maximum drainage areas shall conform to Table 2-5-1.
2. T - is the top width of parabolic flumes. The minimum top widths and maximum drainage areas shall conform to Table 2-5-2.
3. H - is the height of the dike at the entrance to the structure and shall be a minimum of 2.5 feet.
4. d - is the depth of the paved down slope section and shall be a minimum of 10 inches for trapezoidal or rectangular flumes. The depths of parabolic flumes shall be as shown in Table 2-5-2.

5. L - is the length of the inlet and outlet paved sections and each shall be a minimum of 6 feet.

The above dimensions are illustrated in Figure 2.5-I.

If a minimum of 75% of the drainage area will have a good grass or woodland cover throughout the life of the structure, the drainage areas listed in Tables 2-5-1 and 2-5-2 may be increased by 50%. If a minimum of 75% of the drainage area will have a good mulch cover throughout the life of the structure, the drainage area listed in Tables 2-5-1 and 2-5-2 may be increased by 25%.

Flumes with dimensions and associated drainage areas other than those shown in this standard shall be designed on an individual job basis. Capacities shall be determined by acceptable hydrologic and hydraulic computations, as noted under Pipe Drops of this Standard.

TABLE 2-5-1

FLUMES WITH TRAPEZOIDAL AND RECTANGULAR SECTIONS

BOTTOM WIDTHS AND DRAINAGE AREA FOR TRAPEZOIDAL FLUMES WITH FLOW DEPTHS EQUAL 10 INCHES		BOTTOM WIDTHS AND DRAINAGE AREA FOR RECTANGULAR FLUMES WITH FLOW DEPTHS EQUAL 10 INCHES	
Bottom Width (feet)	Drainage Area (acres)	Bottom Width (feet)	Drainage Area (acres)
2	7	2	3
4	10	4	5
6	13	6	10
8	16	8	13
10	19	10	16
12	24	12	20

Dikes to be 2.5 feet in height above flume entrance

TABLE 2-5-2

FLUMES WITH PARABOLIC SECTIONS

DEPTHS EQUAL 1 FOOT		DEPTHS EQUAL 1.5 FEET	
Top Width (feet)	Drainage Area (acres)	Top Width (feet)	Drainage Area (acres)
4	3	4	4
6	4	6	5
8	5	8	5
10	6	10	7
12	7	12	8
14	8	14	10
		16	11

Dikes to be 2.5 feet in height above flume entrance

Pipe Drops

The design capacity shall be as required to pass peak runoff from a 10-year frequency, storm.

Peak discharge values shall be determined by the following:

- A. Rational Method - for peak discharge of uniform drainage areas up to one half of a square mile as outlined in Technical Manual for Stream Encroachment, Trenton, N.J., Bureau of Flood Plain Management, August 1984.
- B. SCS Technical Release No. 55 - for drainage area less than five square miles.
- C. For areas greater than or equal to five square miles, use SCS Technical Release No. 20 or other officially approved methodology.

Pipe capacities may be determined from charts in Chapter 6, Ref. (1), or other accepted sources.

A hood inlet type entrance should be used as shown in Figure 2.5-II. The pipe drop inlet shall be protected by riprap or concrete.

Flexible Downdrain

A heavy duty fabric or other material may be used as a temporary or interim structure, as shown in Figure 2.5-III. Use of flexible down drains is not recommended during the winter months. Standard metal end sections shall be used.

Outlet protection shall be provided by riprap or other means.

Diversion dikes or deep curb cuts shall be used in conjunction with pipe drops. The dike height above the pipe inlet invert shall be adequate to contain a water elevation sufficient to cause full pipe flow plus an allowance of at least 0.5 feet for freeboard. A minimum water depth of 1.8 times the pipe diameter above pipe inlet invert is required to assure full pipe flow.

Installation Requirements

1. The structure shall be placed on undisturbed soil or well-compacted fill.
2. The cut or fill slope shall not be steeper than 1 vertical to 1.5 horizontal (1.5:1) and should not be flatter than 20:1.
3. Adequate vegetative protection per vegetation standards and drainage works shall be installed.
4. Open Flume
 - a. The top of the earth dikes shall not be lower at any point than the top of the lining at the entrance of the structure.
 - b. The lining should be placed beginning at the lower end and proceeding up the slope to the upper end. The lining shall be well-compacted and free of voids.
 - c. The entrance floor at the upper end of the structure shall have a slope toward the outlet of 1/4 to 1/2 inch per foot.
5. Hood Inlet Pipe Drops
 - a. The pipe shall be imbedded in the embankment to a depth that will insure stability.
 - b. Protection measures of concrete or riprap shall be installed at the inlet and outlet as needed to protect against erosion.
 - c. The pipe may be smooth or corrugated and shall be of the required strength and durability.
 - d. Backfill shall be carefully placed in layers and tamped to insure adequate compaction.
6. Outlet Protection in accordance with the Conduit Outlet Protection Standard, p. 2-14-1.

FIGURE 2.5-I
TYPICAL OPEN FLUME

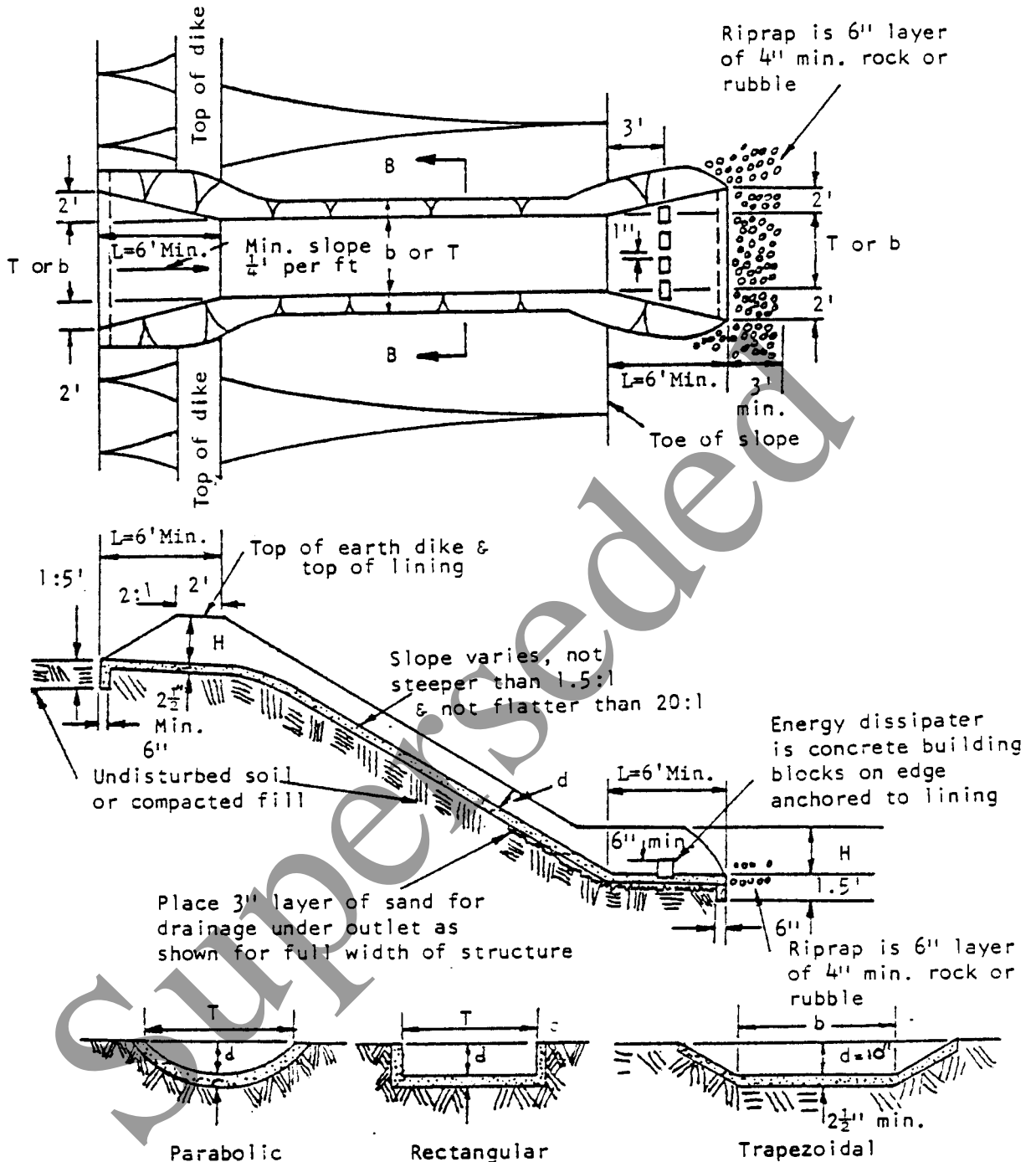

Alternate Sections B-B

Notes:

1. Lining shall be Portland Cement concrete, bituminous concrete or comparable material, reinforced where necessary.
2. Some type of energy dissipater, such as the one shown above, must be used to prevent erosion at the outlet.
3. The paved down slope section should have side slopes as required by construction methods.
4. The Standard for Conduit Outlet Protection [4-1] shall also apply.

FIGURE 2.5-II
BANK PROTECTION STRUCTURE
Hood Inlet Pipe

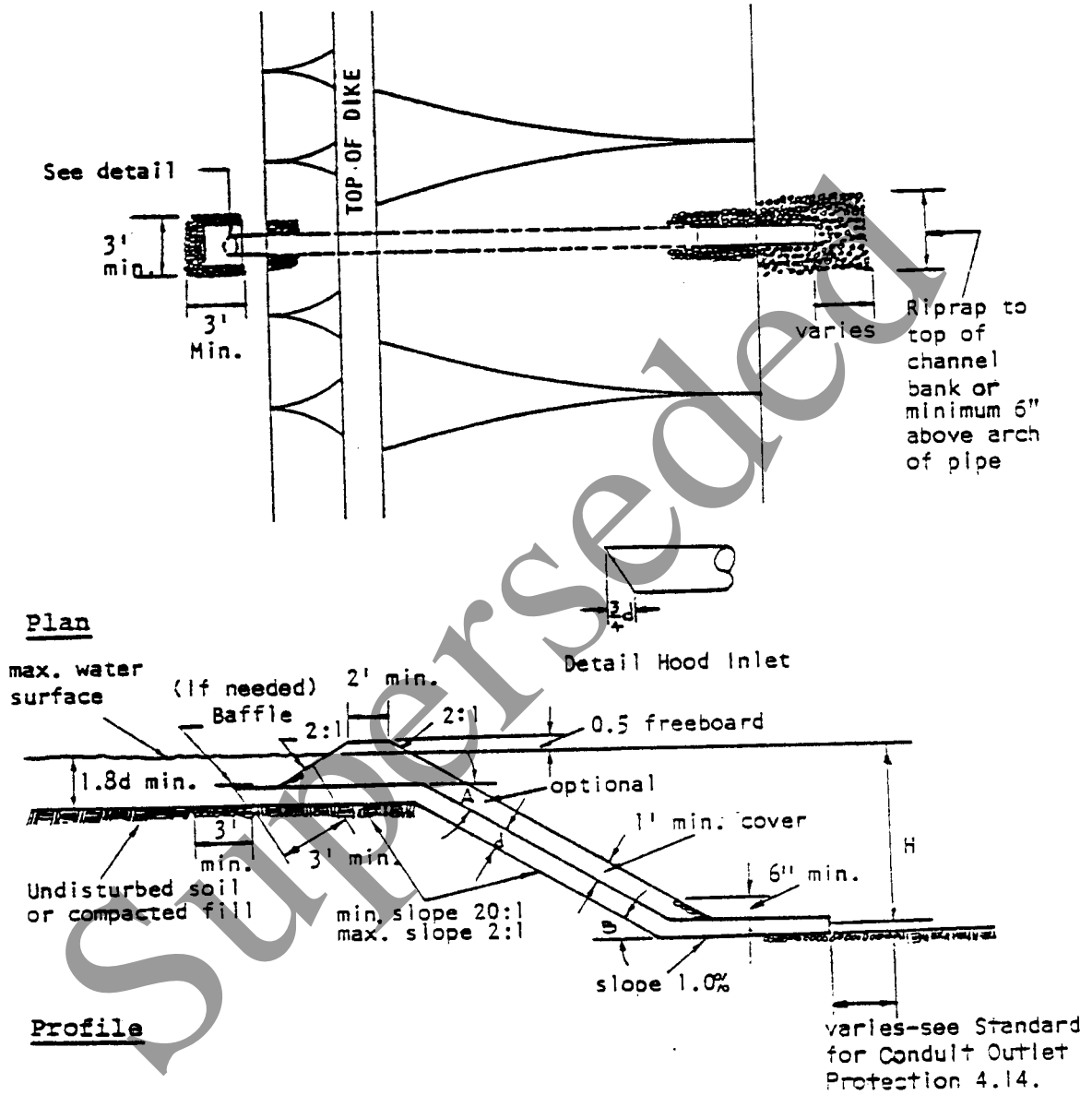

No scale

Figure 2.5-III

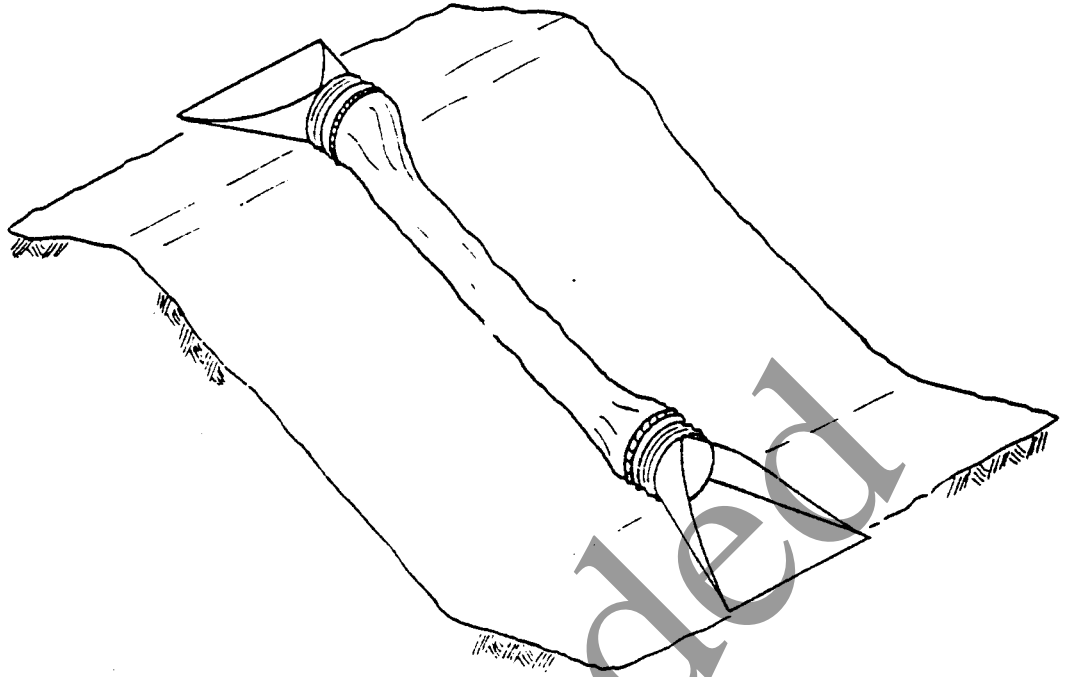

Flexible down drain - isometric



Flexible down drain - installed

MAINTENANCE:

Inspect for clogging or damage after each storm. In below freezing weather, check to ensure that sides of collapsed down drain are not frozen together. Do not allow placement of any material on collapsed down drain. Inlet section should be checked for indications of piping along metal sections. Anchors should be resecured as necessary.

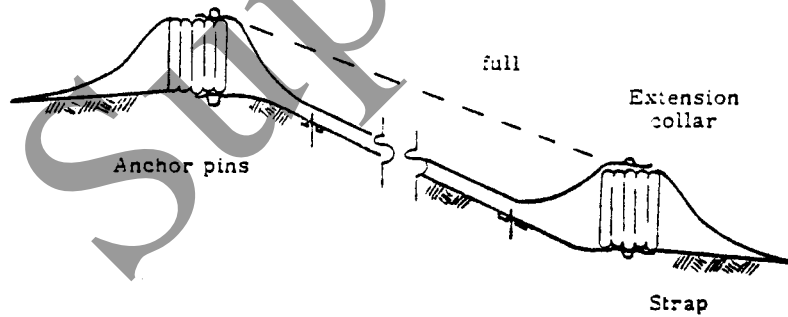
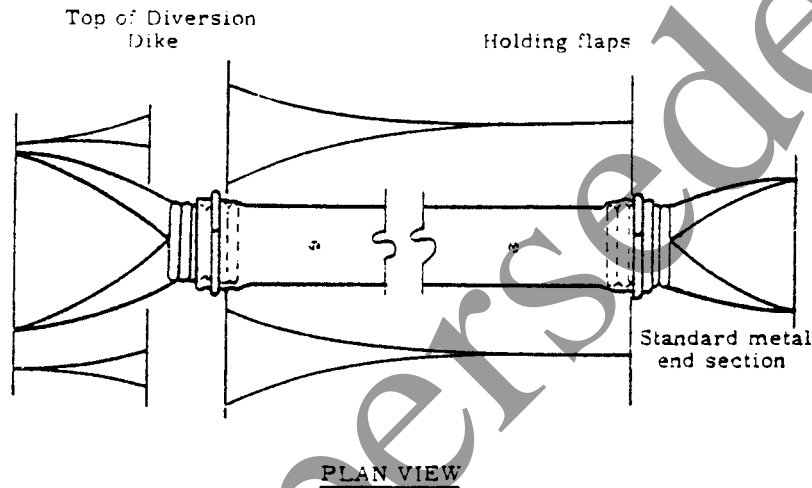

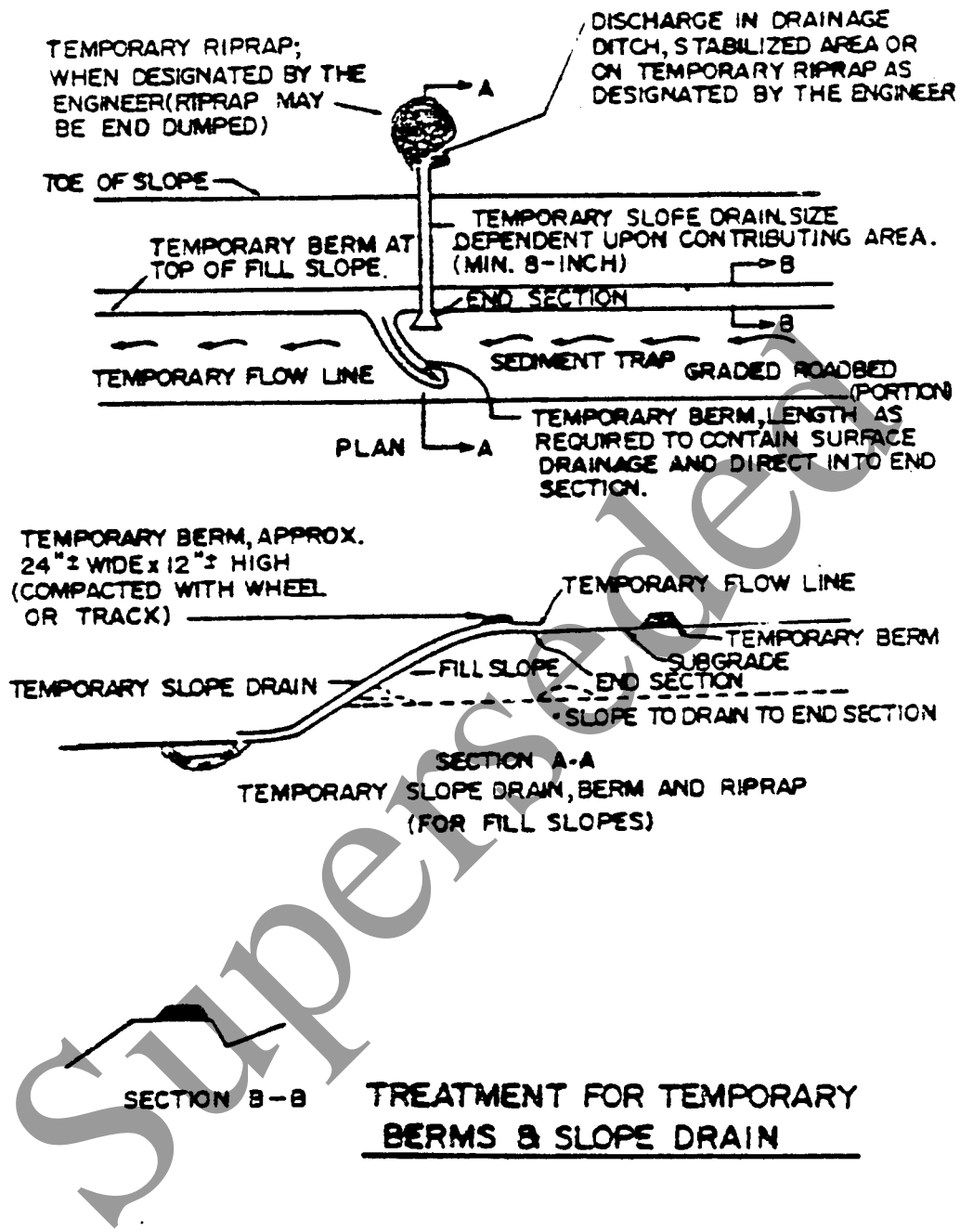

Superseded

STANDARD
FOR
CHANNEL STABILIZATION

Definition

Stabilizing a channel, either natural or artificial, in which water flows with a free surface.

Purpose

Open channels are constructed or stabilized to be nonerodible and provide adequate capacity for the conveyance of flood water, draining, other water management purposes, or any combination thereof.

Conditions Where Practice Applies

This standard applies to the construction and stabilization of open channels, and existing streams or ditches regardless of drainage area. It does not apply to diversions or grassed waterways.

Design Criteria

Planning

The alignment and design of channels shall give careful consideration to the preservation of valuable fish and wildlife habitat. Trees of significant value for wildlife food or shelter shall be preserved whenever possible.

Where channel construction will adversely affect a significant fish or wildlife habitat, mitigation measures should be included in the plan. Mitigation measures may include pools, riffles, flats, cascades, or other similar provisions.

As many trees as possible are to be left considering the requirements for construction, operation, and maintenance. See Standard for Tree Protection During Construction, p. 1-7-1.

Realignment

The realignment of channels shall be kept to an absolute minimum.

Channel Capacity

The capacity for open channels shall be determined by the designer and/or the appropriate regulatory authority.

Capacity shall be determined by the following methods:

1. Rational Method - for peak discharge of uniform drainage areas up to one half of a square mile as outlined in Technical Manual for Stream Encroachment, Trenton, N.J., Bureau of Flood Plain Management, August 1984.
2. SCS Technical Release No. 55 for drainage areas less than five square miles.
3. For areas greater than or equal to five square miles, use SCS Technical Release No. 20 or other officially approved methodology.

Hydraulic Requirements

Manning's formula shall be used to determine the velocities in the channels.

The "n" values for use in this formula shall be estimated using currently accepted guides along with knowledge and experience regarding the conditions.

Acceptable guides can be found in Refs. 6, 7, and Appendix A3.

Every reach shall be individually designed unless all reaches are designed on the worst cases for velocity and capacity (lowest allowable velocity, steepest slope).

Channel Side Slopes

Channel side slopes in earth shall be 2:1 or flatter unless the design, using the procedures in Appendix A3, shows that a steeper side slope is stable. Channel side slopes of materials other than earth shall be designed stable.

Channel Stability (General)

All channel construction, improvement, and modification shall be in accord with a design which results in a stable channel.

Characteristics of a stable channel are:

1. It neither aggrades nor degrades beyond tolerable limits.
2. The channel banks do not erode to the extent that the channel cross section is changed appreciably.
3. Excessive sediment bars do not develop.
4. Excessive erosion does not occur around culverts and bridges or elsewhere.

5. Gullies do not form or enlarge due to the entry of uncontrolled surface flow to the channel.

The determination of channel stability considers bankfull flow. Bankfull flow is defined as the flow in the channel which creates a water surface that is at or near normal ground elevation for a significant length of a channel reach. Excessive channel depth created by cut through high ground, such as might result from realignment of the channel, should not be considered in determinations of bankfull flow.

Channel Stability (drainage area of one square mile or less)

1. Permanent

Channels in this category shall be considered stable if the actual velocity is less than the allowable velocities shown in Table 2-6-1. The actual velocity is defined as the velocity developed during the lesser of the following events:

- a. Bankfull discharge
- b. 10-year frequency, storm, peak discharge

2. Temporary (90 days or less) Bypass Channel

Channels in this category shall be considered stable if the actual velocity is less than the allowable velocities shown in Table 2-6-1. The actual velocity is defined as the velocity developed during the 2-year frequency peak discharge.

TABLE 2-6-1

ALLOWABLE VELOCITY FOR VARIOUS SOIL TEXTURES

SOIL TEXTURE	ALLOWABLE VELOCITY ft./sec.
Sand	1.75
Sandy loam	2.5
Silt loam	3.0
Sandy clay loam	3.5
Clay loam	4.0
Clay, fine gravel, graded loam to gravel	5.0
Cobbles	5.5
Shale (nonweathered shale)	6.0

Linear crossing of existing channels by pipelines and similar devices do not require a stability analysis of the channel provided the final cross sectional area of the stream remains the same.

Channel Stability (drainage area greater than one square mile)

Channels must be stable under conditions existing immediately after construction (as-built condition) and under conditions existing during effective design life (aged condition). Channel stability shall be determined for discharges under these conditions as follows:

1. As-built condition - Bankfull flow, design discharge, or 10-year frequency flow, whichever is smallest, but not less than 50% of design discharge.
2. Aged condition - Bankfull flow or design discharge, whichever is larger, except that it is not necessary to check stability for discharges greater than the 100-year frequency.

Stability checks are not required if the actual velocity is 1.75 fps or less.

Linear crossing of existing channels by pipelines and similar devices do not require a stability analysis of the channel provided the final cross sectional area of the stream remains the same.

Where vegetation can be rapidly established by natural or artificial means, the allowable as-built velocity (regardless of type stability analysis) in the newly constructed channel may be increased by a maximum of 20%. The 20% adjustment does not apply to the allowable velocity for aged condition. This increase is justified only if:

1. The soil and site in which the channel is to be constructed are suitable for rapid establishment and support of erosion-controlling vegetation,
2. Species of erosion-controlling vegetation adapted to the area and proven methods of establishment are known, and
3. The channel design includes detailed plans for establishing vegetation on the channel side slopes.

For newly constructed channels in fine-grained soils and sands, the "n" values shall be determined according to specifications in Appendix A3 and shall not exceed 0.025. The "n" value for channels to be modified by clearing and snagging only shall be determined by reaches according to the expected channel condition upon completion of the work.

The above stability checks will be made using either tractive stress of allowable velocity procedures given in Appendix A3. The choice of method will depend upon the grain size and cohesiveness of the soil being checked. The following will be used as a guide in choosing the method:

- A. Tractive Stress - see Appendix A3
 - 1. Coarse grained soils
 - 2. Fine grained noncohesiveness soils (PI ≤ 10)
- B. Allowable Velocity - see Appendix A3
 - 1. Coarse grained soils (tractive stress procedure recommended)
 - 2. Fine grained cohesive soils (PI > 10)
 - 3. Fine grained noncohesive soils (PI ≤ 10) (tractive stress procedure recommended)

Stability checks should be made for each significant soil horizon present. Soil sampling and testing is required to determine the grain size distribution and plasticity index of each material to be checked.

Channel Linings and Structural Measures

Where channel velocities exceed allowable velocities, the channel must be stabilized.

Channels may be stabilized by using one or more of the following methods:

- 1. Rock Riprap Lining shall be designed using the procedures given in Standard for Riprap, p. 2-12-1.
- 2. Concrete Lining shall be designed according to currently accepted guides for structural and hydraulic adequacy. They must be designed to carry the required discharge and to withstand the loading imposed by site conditions. Concrete lining shall be reinforced where required.
- 3. Grade Stabilization Structures can be used where excessive grades exist. The structures provide for one or more drops along the channel profile to reduce the channel slope. See Standard for Grade Stabilization Structure, p. 2-17-1.

They may be constructed of concrete, rock, masonry, steel, gabions, aluminum, or treated timber.

The structures must be designed hydraulically to adequately carry the channel discharge and structurally to withstand loadings imposed by the site conditions.

Chapter 6, Ref. #8, provides procedures for use in the design of these structures.

Energy Dissipaters are employed to force hydraulic jump and its associated turbulence to occur at a location where suitable protection can be provided against bank scour and channel erosion. Construction of

energy dissipaters is normally at the base of chutes or drop structures and they are usually an integral part of the design of the structure. Sills, baffles, floor blocks, or other obstructions to channel flow may serve as energy dissipaters.

Chapter 15, Ref. #6, provides design considerations for energy dissipation with the hydraulic jump.

Installation Requirements

1. All trees, brush, stumps, and other objectionable materials that would interfere with the construction or proper functioning of the channel shall be removed.
2. Where possible, trees will be left standing, brush and stumps will not be removed, and channels will be excavated from one side, leaving vegetation on the opposite side.
3. Construction plans will specifically detail the location and handling of spoils.
4. Seeding, fertilizing, and mulching shall conform to the Standard for Permanent Vegetative Cover for Soil Stabilization, p. 1-2-1.
5. Vegetation shall be established on all disturbed areas immediately after construction, weather permitting. If weather conditions are such as to cause a delay in the establishment of vegetation, the area shall be mulched in accordance with the Standard for Stabilization with Mulch Only, p. 1-3-1.

STANDARD
FOR
DETENTION BASIN
FOR CONTROL OF DOWNSTREAM EROSION

Definition

A basin providing for temporary storage of stormwater and for its controlled release.

Basins created by construction of dams or barriers are referred to as "Embankment Basins" and those constructed by excavation as "Excavated Basins." Basins resulting from both excavation and embankment construction are classified as "Embankment Basins" where the depth of water impounded against the embankment at emergency spillway elevation is 3 feet or more.

Scope

This standard covers the installation of all detention basins (sometimes referred to as retention basins).

Purpose

Detention basins are an available option to reduce erosion damages downstream by controlling the release from flows of predetermined frequencies. They may also permit the use of more economical channel improvements or stabilizing structures in the channel downstream and reduce environmental hazards and pollution.

Conditions Where Practice Applies

This practice applies if there is a potential for increased downstream erosion due to construction at development sites, or from other land use changes, or if local ordinances require storm detention basins. The increased downstream erosion may be caused by increased runoff volume, and/or increased peak discharge. If the detention basin is also intended to comply with the provisions of the Stormwater Management Act of 1981, regulations promulgated by DEP pursuant to that Act shall apply. Where Infiltration Basins are proposed, the existence of a stable condition at the emergency discharge area must be provided, and for offsite stability analysis it must be assumed that infiltration will not reduce the peak runoff for a 10 year storm.

Design Criteria

Structural aspects of detention basins shall be as stipulated by applicable state requirements. In the absence of such criteria, Appendix A-6, Structural Guidelines for Detention Basins, may be used. In addition, it must be shown for the peak outflow, as determined by the Rational Method or TR55, that there will be no soil erosion and sedimentation problems off-site. A detailed hydraulic analysis of the detention basin shall be submitted.

Design Storms

The peak discharge from the 2-year and 10-year frequency storm shall be analyzed. Frequency, duration, and distribution shall be as defined in the SCS Technical Release 55. No increase in peak discharge caused by construction operations or changes in land use shall be allowed unless the increase in peak discharge does not result in increased potential for erosion.

The peak runoff may be determined by the rational method up to one half square mile.

Design storm and volume may be determined by the modified rational method on drainage basins up to 20 acres, as described in Special Report 43 by the American Public Works Association, Practices in Detention of Urban Stormwater.

If there is an overall storm water management plan for the watershed that considers erosion, downstream peak flow increases that are compatible with the overall plan may be allowed.

Outlets for Conduits

Protection against scour at the discharge end of the spillway shall be provided in accordance with the Standard for Conduit Outlet Protection (2-14), or by suitable hydraulic structures proven effective by properly documented research.

Vegetation

The dam, emergency spillway, spoil and borrow areas, and other disturbed areas above the crest of the principal spillway shall be vegetated in accordance with the Standard for Permanent Vegetative Cover for Soil Stabilization, p. 1-2-1. All cut or fill slopes should be flat enough to accommodate the proposed operation and maintenance equipment.

Safety

Detention basins attract children and can be very dangerous. They should be fenced or otherwise made inaccessible to persons or animals unless deemed unnecessary due to the remoteness of the site or other circumstances. In any case, local, county, or state regulations regarding health and safety must be adhered to. This portion of the Standard is for guidance only.

Ownership

Ownership and responsibility for operation and maintenance of the detention basin must be determined during the design and must be shown on the plans. To be effective over a long period of time, the structure must be properly maintained. Detention basins should normally be owned by a unit of government that accepts responsibility for the structure and can obtain the money necessary to do operation and maintenance work.

Operation and Maintenance

A plan of operation and maintenance shall be prepared for use by the owner or others responsible for the structure to insure that the structure functions properly. This plan shall provide requirements for at least annual inspection, operation, and maintenance of individual components, including outlets. It shall be prepared during design and shall specify who is responsible for maintenance. Adequate access must be provided for maintenance. Any additional requirements of the New Jersey Department of Environmental Protection shall be met where applicable.

Superseded

Superseded

STANDARD
FOR
SUBSURFACE DRAINAGE

Definition

Removal of water through the soil by conduit, such as tile, pipe, or tubing, installed beneath the ground surface to collect and convey drainage water.

Purpose

A drain may serve one or more of the following purposes:

1. Improve vegetation by lowering the water table.
2. Intercept and prevent water movement into a potentially wet area.
3. Relieve artesian pressures.
4. Reduce surface runoff.
5. Serve as an outlet for other drains.
6. Replace natural subsurface drainage patterns which are interrupted by construction operations.

Conditions Where Practice Applies

Drains are used in areas having a high water table where benefits of lowering groundwater or controlling surface runoff justify the installation of such a system.

The soil shall have enough depth and permeability to permit installation of an effective system. On-site investigations are required.

An outlet for the drainage system shall be available, either by gravity flow or by pumping. The outlet shall be adequate for the quantity and quality of effluent to be disposed of with consideration of possible damages above or below the point of discharge.

Design Criteria

The design and installation shall be based on adequate surveys and investigations.

Design Inflow

The design inflow can be determined by the use of the method described in reference (9), the use of Table 2-8-1, or by other accepted methods.

TABLE 2-8-1

INFLOW RATES FROM DIFFERENT SOIL TEXTURES 1/ 2/

SOIL TEXTURE	UNIFIED SOIL CLASSIFICATION	INFLOW RATE PER 1000 FT. OF LINE IN CFS
Coarse sand and gravel	GP, GW, SP, SW	0.15 to 1.00
Sandy or gravelly loam	SM, SC, GM, GC	0.07 to 0.25
Silt loam	CL, ML	0.04 to 0.10
Clay and clay loam	CL, CH, MH	0.02 to 0.20

1/ Required inflow rates for interceptor lines on sloping land should be increased by 10% for slopes 2% to 5%; 20% for slopes 5% to 12%; and 30% for slopes over 12%.

2/ For complete drainage systems, use the lower value in the above table for the given soil texture.

Size of Drain

The size of drains shall be computed by applying Manning's formula, or by the method contained in Chapter 14, Ref. (1).

The minimum drain shall be equivalent to a 4-inch diameter pipe.

Depth, Spacing, and Location

The depth, spacing, and location of the drain shall be based on site conditions including soils, groundwater conditions, topography, and outlets.

Minimum Velocity and Grade

In areas with no siltation hazard, the minimum grades shall be 0.1%. Where it is determined that a siltation hazard exists, velocity of not less than 1.4 feet per second shall be used to establish the minimum grades if site conditions permit. Otherwise, provisions shall be made for prevention of siltation by filters or collection and removal of silt by use of silt traps.

Maximum Grade and Protection

On sites where topographic conditions require the use of drain lines on grades steeper than 2% or where design velocities will be greater than indicated in Table 2-8-2, special measures shall be used. These measures shall be specified for each job based on the particular conditions of the job site. Possible protective measures include the following:

1. Lay the drains so as to secure a tight fit with the inside of one section matching that of the adjoining section.
2. Wrap open joints with tar impregnated paper, burlap, or special filter material such as plastic or fiber glass fabrics.
3. Select the least erodible soil available for hand placing on sides and top of conduit, which must be tamped before backfilling. Tamped thickness of this material over conduit shall be a minimum of two inches.
4. For continuous pipe or tubing with perforations, completely enclose the pipe with filter material of plastic, fiber glass, or properly graded sand and gravel as specified under filters and filter materials on page 2-8-4.
5. Install relief vents where changes in grade exceed 5 percent.

TABLE 2-8-2

MAXIMUM PERMISSIBLE VELOCITIES IN DRAINS WITHOUT PROTECTIVE MEASURES

<u>SOIL TEXTURE</u>	<u>VELOCITY - FEET PER SECOND</u>
Sandy loam	2.5
Silt and silt loam	4.0
Silty clay loam	5.0
Clay and clay loam	6.0
Coarse sand and gravel	8.0

Materials for Drains

"Drains" include conduits of clay, concrete, bituminized fiber, metal, plastic, or other materials of acceptable quality.

The conduit shall meet strength and durability requirements of the site.

Loading

The allowable loads on drain conduits shall be based on the trench and bedding conditions specified for the job. A factor of safety of not less than 1.5 shall be used in computing the maximum allowable depth of cover for a particular type of conduit.

Filters and Filter Material

Suitable filters shall be used, where required by site conditions, to prevent sediment accumulation in the conduit. The need for a filter shall be determined by the characteristics of the soil materials at drain depth and the velocity of flow in the conduit.

Not less than three inches of filter material shall be used for sand-gravel filters.¹ Filters of organic material such as salt hay, straw, or wood chips shall provide a six-inch thickness.

Where fiber glass material is used, it shall be manufactured from borosilicate type glass and the manufacturer of the material shall certify that it is suitable for underground use. The material shall cover all open joints and perforations.

Envelopes shall be used around drains where necessary to improve flow characteristics of groundwater into the conduit.

Installation Requirements

All drains shall be laid to line and grade, and covered with not less than three inches of approved hand placed backfill and/or filter material. The upper end of all drain lines shall be closed with concrete or other durable material unless connected to a structure.

Earth backfill material shall be placed in the trench in such a manner that displacement of the drain will not occur, and so that the filter material, after backfilling, will meet the requirements of the design.

The gap between drain pipe joints shall not exceed one-fourth inch for mineral soils or one-half inch for organic soils. Openings wider than these shall be covered with fiber glass or other suitable material.

If the conduit is to be placed in a rock-trench, or where rock is exposed in the bottom of the trench, the rock shall be removed below grade deep enough so that the trench may be backfilled, compacted, and bedded so that the conduit is not less than two inches from rock.

When iron sulfide chemical reaction causes sealing of joints or perforations, the drain shall be enclosed in a clean sand-gravel filter. Riser pipes for flushing the line shall be provided at intervals not to exceed 500 feet.

1A recommended method of installation is to place filter material to a depth of three inches under the drain, and cover the drain and filter with a sheet of plastic. The filter shall be designed to prevent the material in which the installation is made from entering the drain. Not more than 10% of the filter shall pass the No. 60 sieve.

Superseded

Superseded

STANDARD
FOR
TRAFFIC CONTROL

Definition

The control of on-site construction traffic (construction equipment, service vehicles, autos, etc.) during development of a parcel of land.

Purpose

To minimize land disturbance.

Where Applicable

Any area where vehicular traffic disturbs the land to the extent of reducing protective vegetation, compacting soil, or otherwise deteriorating the environment.

Planning Criteria

Restrict construction traffic to predetermined routes according to types and numbers of vehicles anticipated. Markers or temporary fencing may be helpful.

Avoid damage to waterways by construction of suitable crossing facilities and avoid traffic in or along streams.

Predetermine steep banks and vegetative areas to be avoided by traffic.

Traffic during wet weather should be minimized.

Sediment from tire washing operations shall be retained on site. Water shall be conveyed to a stable outlet.

Superseded

STANDARD
FOR
DUST CONTROL

Definition

The control of dust on construction sites and roads.

Purpose

To prevent blowing and movement of dust from exposed soil surfaces, reduce on-site and off-site damage and health hazards, and improve traffic safety.

Where Applicable

This practice is applicable to areas subject to dust blowing and movement where on-site and off-site damage is likely without treatment. Consult with local municipal ordinances on any restrictions.

Planning Criteria

The following methods should be considered for controlling dust:

Mulches - See Standard for Stabilization with Mulches Only (p. 1-3-1).

Vegetative Cover - See Standard for: Temporary Vegetative Cover (p. 1-2-1), Permanent Vegetative Cover (p. 1-1-1), and Permanent Stabilization with Sod (p. 1-4-1).

Spray-On Adhesives - On mineral soils (not effective on muck soils). Keep traffic off these areas.

	WATER DILUTION	TYPE OF NOZZLE	APPLY GALLONS/ACRE
Anionic asphalt emulsion	7:1	Coarse Spray	1,200
Latex emulsion	12.5:1	Fine Spray	235
Resin in water	4:1	Fine Spray	300

Tillage - To roughen surface and bring clods to the surface. This is a temporary emergency measure which should be used before soil blowing starts. Begin plowing on windward side of site. Chisel-type plows spaced about 12 inches apart, and spring-toothed harrows are examples of equipment which may produce the desired effect.

Sprinkling - Site is sprinkled until the surface is wet.

Barriers - Solid board fences, snow fences, burlap fences, crate walls, bales of hay, and similar material can be used to control air currents and soil blowing.

Calcium Chloride - Shall be in the form of loose, dry granules or flakes fine enough to feed through commonly used spreaders at a rate that will keep surface moist but not cause pollution or plant damage. If used on steeper slopes, then use other practices to prevent washing into streams, or accumulation around plants.

Stone - Cover surface with crushed stone or coarse gravel.

Superseded

STANDARD
FOR
LINED WATERWAY

Definition

A watercourse with an erosion resistant lining of concrete, stone, or other permanent material. The lined section extends up the side slopes to design flow depth. The earth above the permanent lining shall be vegetated or otherwise protected.

Scope

This standard applies to waterways with linings of non-reinforced, cast-in-place concrete; flagstone mortared in place; rock riprap or similar permanent linings. This standard does not apply to grassed waterways with stone centers. The maximum capacity of the lined waterway flowing at design flow depth shall not exceed 100 cfs.

Purpose

Waterways are lined to provide for safe disposal or runoff without damage by erosion or flooding, in situations where grassed waterways would be inadequate.

Conditions Where Practice Applies

This practice applies where the following conditions exist:

1. The water velocity is such that lining is required to control erosion in the waterway.
2. Wetness, prolonged base flow, or seepage, would prohibit establishment of erosion-resistant vegetation.
3. The location is such that damage from use by people, vehicles, or animals precludes use of vegetated waterways.
4. High value property or adjacent facilities warrant the extra cost to contain design runoff in a limited space.
5. Soils are highly erodible, highly acidic, or other soil or climatic conditions precludes using vegetation.
6. On slopes greater than 10%, the Standard for Slope Protection Structures (2-5-1) shall apply.

Design Criteria

Capacity

The minimum capacity shall be adequate to carry the peak rate of runoff from a 10-year frequency storm. Capacity shall be computed using Manning's formula with a coefficient of roughness "n" as follows:

LINING	"n" VALUE
Concrete	
Trowel finish	0.012 - 0.014
Float finish	0.013 - 0.017
Gunite	0.016 - 0.022
Flagstone	0.020 - 0.025
Gabion	0.025
Riprap	see the Standard for Riprap

Velocity

Maximum design velocity shall be as shown below. Except for short transition sections, slopes in the range of 0.7 to 1.3 of the critical slope must be avoided unless the channel is straight. Velocities exceeding critical will be restricted to straight reaches.

DESIGN FLOW DEPTH	MAXIMUM VELOCITY
0 - 0.5'	25 fps
0.5 - 1.0'	15 fps
> 1.0'	10 fps

Lined waterways with velocities exceeding critical shall discharge into an energy dissipator to reduce velocity to less than critical.

Cross-Section

The cross-section shall be triangular, parabolic, or trapezoidal. Monolithic concrete may be rectangular.

Freeboard

The minimum freeboard for lined waterways shall be 0.25 feet above design flow depth in areas where erosion resistant vegetation cannot be grown adjacent to the lined side slopes. No freeboard is required where good vegetation can be grown and is maintained.

Side Slope

Steepest permissible side slopes, horizontal to vertical will be as follows:

LINING	STEEPEST PERMISSIBLE SIDE SLOPE
Non-Reinforced Concrete - Hand-placed, formed concrete Height of lining 1.5 feet or less	vertical
Hand-placed, screeded concrete or mortared in-place flagstone - Height of lining less than 2 feet	1 to 1
Height of lining more than 2 feet	2 to 1
Reinforced slip form concrete - Height of lining less than 3 feet	1 to 1
Rock riprap	2 to 1

Lining Thickness

Minimum lining thickness shall be as follows:

Concrete - 4 inches

Rock riprap - as per Standard for Riprap

Flagstone - 4 inches including mortar bed

Related Structures

Side inlets, drop structures, and energy dissipators shall meet the hydraulic and structural requirements for the site.

Filters or bedding

For non-reinforced concrete flagstone linings, installation shall be made only on low shrink-swell soils that are well drained or where subgrade drainage facilities are installed.

Filters or bedding to prevent piping, prevent erosion, reduce uplift pressure, and collect water will be used and will be designed in accordance with "National Cooperative Highway Research Program Report 108 - Tentative Design Procedures for Riprap-Lined Channels," Soil Conservation Service procedures or other generally accepted methods. Weep holes and drains will be provided as needed.

Concrete or Mortar

Concrete or mortar shall meet New Jersey Department of Transportation Standard Specifications, Ref. #10, Appendix A7.

Rock Riprap or Flagstone

Stone used for riprap or flagstone shall be dense and hard enough to withstand exposure to air, water, freezing, and thawing. Flagstone shall be flat for ease of placement.

Superseded

STANDARD
FOR
RIPRAP

Definition

A layer of loose rock, aggregate, bagged concrete, gabions, or concrete revetment blocks placed over an erodible soil surface.

Purpose

The purpose of riprap is to protect the soil surface from the erosive forces of water.

Conditions Where Practice Applies

This practice applies to soil-water interfaces where the soil conditions, water turbulence and velocity, expected vegetative cover, and groundwater conditions are such that the soil may erode under the design flow conditions. Riprap may be used, as appropriate, at such places as channel banks and/or bottoms, roadside ditches, and drop structures. This Standard applies to slopes less than ten percent.

Design Criteria

Design Storm

The riprap shall be designed to be stable when the channel is flowing at the design discharge or the 25-year frequency storm discharge, whichever is greater.

Capacity shall be determined by the following methods:

1. Rational Method - for peak discharges of uniform drainage areas up to one-half of a square mile, as outlined in Technical Manual for Stream Encroachment, Trenton, N.J., Bureau of Flood Plain Management, August 1984.
2. SCS Technical Release No. 55 - for drainage areas less than five square miles.
3. For areas greater than or equal to five square miles, use SCS Technical Release No. 20 or other officially approved methodology.

Riprap Size and Location

Riprap shall be sized using the design procedures in this Standard or the "National Cooperative Highway Research Program Report No. 108, Tentative Design Procedure for Riprap-Lined Channels." These procedures are for determining a design stone size, such that the stone is stable under the design flow conditions. The design stone size is the d_{50} stone diameter.

Erosive forces of flowing water are greater in bends than in straight channels. If the riprap size (d_{50}) computed for bends is less than 10% greater than the riprap size (d_{50}) for straight channels, then the riprap size for straight channels shall be considered adequate for bends. Otherwise, the larger riprap size shall be used in the bend. The riprap size to be used in a bend shall extend upstream from the point of curvature and downstream from the point of tangency, a distance equal to five times the channel bottom width, and shall extend across the bottom and up both sides of the channel.

Riprap for banks shall extend up the banks to the level of the design storm or the top of bank, whichever is lower.

In channels where no riprap or paving is required in the bottom, but is required on the banks, the toe of the bank riprap shall extend below the channel bottom a distance at least 8 times the maximum stone size, but in no case more than 3 feet. The only exemption to this would be if there is a non-erodible hard, rock bottom.

Riprap Gradation

The riprap shall be composed of a well-graded mixture such that 50% of the mixture by weight shall be larger than the d_{50} size as determined from the design procedure. A well-graded mixture as used herein is defined as a mixture composed primarily of the larger stone sizes, but with a sufficient mixture of other sizes to fill the progressively-smaller voids between the stones. The diameter of the largest stone size in such a mixture shall be 1.5 times the d_{50} size.

The designer, after determining the riprap size that will be stable under the flow condition, shall consider that size to be a minimum size and then, based on riprap gradations actually available in the area, select the size or sizes that equal or exceed the minimum size. The possibility of vandalism shall be considered by the designer in selecting a riprap size.

Thickness of Riprap Lining

Construction techniques, discharge, size of channel, sizes and gradation of riprap, etc., should be taken into consideration when determining the thickness of riprap lining. The thickness of riprap lining shall meet at least one of the following two criteria:

1. A thickness of at least three times the d_{50} size if a filter layer is not used.
2. A thickness of at least two times the d_{50} size if a filter layer is used.

The minimum thickness shall be 6 inches.

Filter

Leaching is the process by which the finer base materials beneath the riprap are picked up and carried away by the turbulence that penetrates the interstices of the riprap. Leaching is reduced to a negligible rate by using a properly designed filter under the riprap, or by making the riprap layer thick enough and with fine enough interstices to keep erosion currents away from underlying soil.

A filter is required unless the riprap lining has a thickness of at least 3 times the d_{50} size of the riprap. On steep slopes, highly erodible soils, loose sand, or with high water velocities, a filter should be used or riprap thickness increased beyond the minimums.

A filter can be of two general forms. One is a synthetic filter fabric manufactured for that express purpose. Another is a properly graded layer of sand, gravel, or stone.

A sand, gravel, or stone filter shall meet the following criteria:

<u>d_{15} Riprap</u>	≤ 5	<u>d_{15} Riprap</u>	≤ 40
d_{85} Filter		d_{15} Filter	
<u>d_{50} Riprap</u>	≤ 40		
d_{50} Filter			

Where d_{15} , d_{50} , and d_{85} are the diameters of riprap and filter material of which 15, 50, and 85% are finer by weight. The base material may be used as the filter if it meets the above criteria. The minimum sand gravel or stone filter thickness shall be 6 inches or 3 times the d_{50} size of the filter, whichever is greater.

Synthetic filter fabric shall meet the following criteria:

- A. For filter fabric adjacent to granular materials containing 50% or less by weight of fines (Minus No. 200 material):
 1. 85% size of material (mm) ≥ 1
EOS* (mm)
 2. Open area not to exceed 36%.
- B. For filter fabric adjacent to all other soils:
 1. EOS* no larger than the opening in the U.S. Standard Sieve No. 70.
 2. Open area not to exceed 10%.

NOTE: No cloth specified should have an open area less than 4% or an EOS* with openings smaller than the opening in a U.S. Standard Sieve Size No. 100. When possible, it is preferable to specify a cloth with openings as large as allowable by the criteria. It may not be possible to obtain a suitable cloth with the maximum allowable openings, which also meets the strength requirements, however, due to the limited number of cloths available.

*EOS, Equivalent Opening Size, is defined as the number of the U.S. Standard sieve having openings closest in size to the filter fabric openings.

Synthetic filter fabric shall meet the U.S. Army Corps of Engineers Guide Specifications, CW02215, November 1977, for strength. Riprap that is 12" and larger shall not be dumped directly onto synthetic filter cloth unless the manufacturer recommends such use for the cloth. Otherwise, a 4-inch minimum, thickness blanket of gravel shall be placed over the filter cloth, or the riprap shall be placed directly on the filter cloth by hand or by the bucket of the equipment.

Quality

Stone for riprap shall consist of field stone or quarry stone of approximately rectangular shape. The stone shall be hard and angular and of such quality that it will not disintegrate on exposure to water or weathering. The specific gravity of the individual stones shall be at least 2.5.

Rubble concrete may be used provided it has a density of at least 150 pounds per cubic foot, and otherwise meets the requirements of this Standard.

Bagged Concrete

Bagged concrete is made up of bags filled with concrete and placed next to each other. The consistency of the concrete shall be as stiff as satisfactory discharge from the mixer and the process of bagging will permit. The bags shall be filled three-quarters full with concrete and shall be laid in close contact, with staggered joints and tied ends turned in.

Bagged concrete may be used when all the following conditions are met:

1. The design storm, riprap size and location, and filter criteria for riprap are met.
2. The weight of the filled bags is at least equal to the weight of the maximum stone size required for rock riprap.
3. Settlement or lateral movement of foundation soils is not anticipated.
4. Ice conditions are not severe.

5. A filter is used.
6. Slopes somewhat steeper than 2 to 1 may be permitted under special circumstances.

Gabions

Gabions are baskets formed of wire mesh and filled with cobbles or coarse gravel. A thinner version of gabions is known as a Reno mattress.

Gabions may be used when all the following conditions are met:

1. The design storm shall be the same as that required for riprap. Riprap size and location, filter, and quality criteria shall be as outlined below.
2. The design water velocity does not exceed that given below:

TABLE 2-12-1

GABION THICKNESS (ft.)	MAXIMUM VELOCITY (ft./sec.)
1/2	6
3/4	11
1	14

3. The Manning's "n" value used for gabions shall be 0.025.
4. The gabions are not exposed to abrasion from sand or gravel transported by moving water.
5. Plastic coated gabions shall be used.
6. All gabions or Reno mattresses placed against the bottom of a channel shall be underlain by filter fabric or a gravel filter designed according to the limits outlined in Table 2-12-2.
7. The rock used to fill the gabions shall be 4" to 7" angular, block-shaped rock.

Table 2-12-2

SOIL TEXTURE	EROSIVE VELOCITY VE	MAXIMUM ALLOWABLE BOTTOM SLOPE USING GEO TEXTILE FABRICS*
Sandy loam	2.5 fps	.029 ft/ft
Silt loam	3.0 fps	.041 ft/ft
Sandy clay loam	3.5 fps	.056 ft/ft
Clay loam	4.0 fps	.074 ft/ft
Clay, fine gravel, graded loam to gravel	5.0 fps	.115 ft/ft
Cobbles	5.5 fps	.139 ft/ft

*For bottom slopes steeper than those shown, a properly designed gravel filter shall be placed under the gabions.

Synthetic filter fabric shall conform to the criteria on p 2-12-3 and 2-12-4 and from Table 2-6-1 of the Channel Stabilization Standard.

Sand, gravel, or stone filters placed under gabions or Reno mattresses shall meet the filter requirements.

Concrete Revetment Blocks

Concrete revetment blocks are precast concrete grids designed for soil stabilization.

Concrete revetment blocks may be used when all the following conditions are met:

1. The design storm shall be the same as that required for riprap.
2. The water velocity does not exceed 9 feet per second.
3. The Manning's "n" value used for concrete revetment blocks shall be 0.026, unless otherwise recommended by manufacturer's literature.
4. A filter is used in accordance with manufacturer's recommendations.

Recommended Design Procedure for Riprap-Lined Channels

This design of riprap-lined channels is from the "National Cooperative Highway Research Program Report No. 108, Tentative Design Procedure for Riprap-Lined Channels." It is based on the tractive stress method, and covers the design of riprap in two basic channel shapes: trapezoidal and triangular.

NOTE: This procedure is for uniform flow at normal depth in channels and is not to be used for design of riprap energy dissipation devices immediately downstream from such high velocity devices as pipes and culverts. See the Standard for Conduit Outlet Protection, p. 2-14-1.

The method in Report No. 108 (design procedure beginning on p. 18) gives a simple and direct solution to the design of trapezoidal channels, including channel carrying capacity, channel geometry, and the riprap lining.

This procedure is based on the assumption that the channel is already designed and the remaining problem is to determine the riprap size that would be stable in the channel. The designer would first determine the channel dimensions by the use of Manning's equation. The "n" value for use in Manning's equation is obtained by estimating a riprap size and then determining the corresponding "n" value for the raprapped channel from $n = 0.0395 d_{50}^{1/6}$, where d_{50} is in feet, or by using Curve 2.12-1, below, where d_{50} is in inches.

CURVE 2.12-1

MANNING'S "n" FOR RIPRAP-LINED CHANNELS

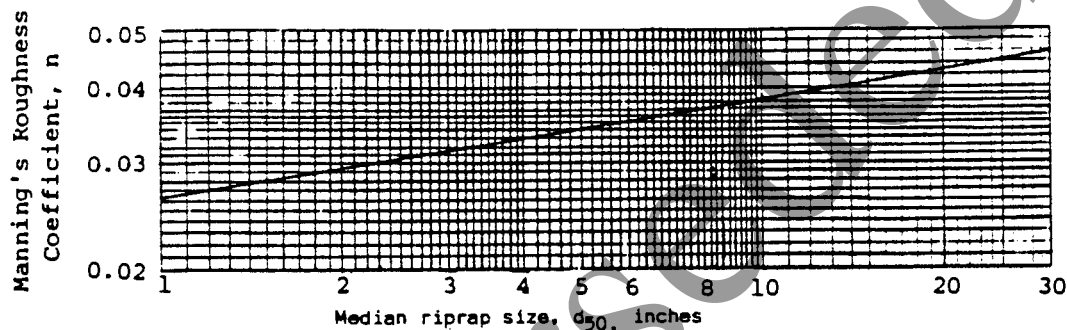

When the channel dimensions are known, the riprap can be designed (or an already completed design may be checked) as follows:

Trapezoidal Channels

1. Calculate the b/d ratio and enter Curve 2.12-2 to find the P/R ratio.
2. Enter Curve 2.12-3 with S_b , Q , and P/R to find median riprap diameter, d_{50} , for straight channels.
3. Enter Curve 2.12-1 to find the actual "n" value corresponding to the d_{50} from step 2. If the estimated and actual "n" values do not reasonably agree, another trail must be made.
4. For channels with bends, calculate the ratio B_s/R_o , where B_s is the channel surface width and R_o is the radius of the bend. Enter Curve 2.12-4 and find the bend factor, FB. Mutiply the d_{50} for straight channels by the bend factor to determine riprap size to be used in bends. If the d_{50} for the bend is less than 1.1 times the d_{50} for the straight channel, then the size for stright channel may be used in the bend; otherwise, the larger stone size calculated for the bend shall be used. The riprap shall extend across the full channel section and shall extend upstream and downstream from the ends of the curve a distance equal to five times the bottom width.

5. Enter Curve 2,12-5 to determine maximum stable side slope of riprap surface. In Curve 2,12-5, the side slope is established so that the riprap on the side slope is as stable as that on the bottom. If for any reason it is desirable to make the side slopes steeper than what is given by Curve 2,12-5, the size of the riprap can be increased and the side slopes made steeper by using the following procedures:
 - a. Compute d_{50} and maximum stable side slope as above.
 - b. Enter Curve 2,12-6 with the computed side slope to determine K for that side slope.
 - c. Enter Curve 2,12-6 with the desired side slope to determine K' .
 - d. Compute riprap size for desired slope by the formula:

$$d_{50}' = d_{50} \frac{K}{K'}$$

6. Maximum side slopes, 2:1.

Triangular Channels

1. Enter Curve 2,12-3A with S_b , Q, and Z and find the median riprap diameter, d_{50} , for straight channels.
2. Enter Curve 2,12-1 to find the actual "n" value. If the estimated and actual "n" values are not in reasonable agreement, another trial must be made.
3. For channels with bends, see step 4 under Trapezoidal channels.

Example:

Given:

Trapezoidal channel

Q = 100 cfs.

S = 0.01 ft./ft.

Side slopes = 2.5:1.

Mean bend radius, $R_0 = 25'$.

n = 0.033 (estimated, and used to design the channel to find that b = 6' and d = 1.8').

Type of rock available is crushed stone.

Solution:

Straight channel reach

$b/d = 6/1.8 = 3.33$.

from Curve 2,12-2, P/R = 13.0.

Riprap

2-12-8

from Curve 2.12-3, $d_{50} = 3.4''$
 from Curve 2.12-1, n (actual) = 0.032, which is reasonably close
 to the estimated n of 0.033
Use 5" as maximum riprap size and 8" as riprap layer thickness
with a filter.

Channel bend

$B_S = b + 2zd = 6 + (2)(2.5)(1.8) = 15'$
 $B_S/R_O = 15/25 = 0.60$.
 from Curve 2-12-4, $F_B = 1.33$
 $F_B = 1.33 > 1.1$, therefore, the bend factor must be used.
 Riprap size in bend, $d_{50} = 3.4 \times 1.33 = 4.52''$

The heavier riprap for the bend shall extend upstream and downstream from the ends of the bend a distance of $(5)(6) = 30$ feet.

From Curve 2.12-5, it can be found that the riprap for $d_{50} = 3.4''$ and $4.52''$ will both be stable on a 2.5:1 side slope.

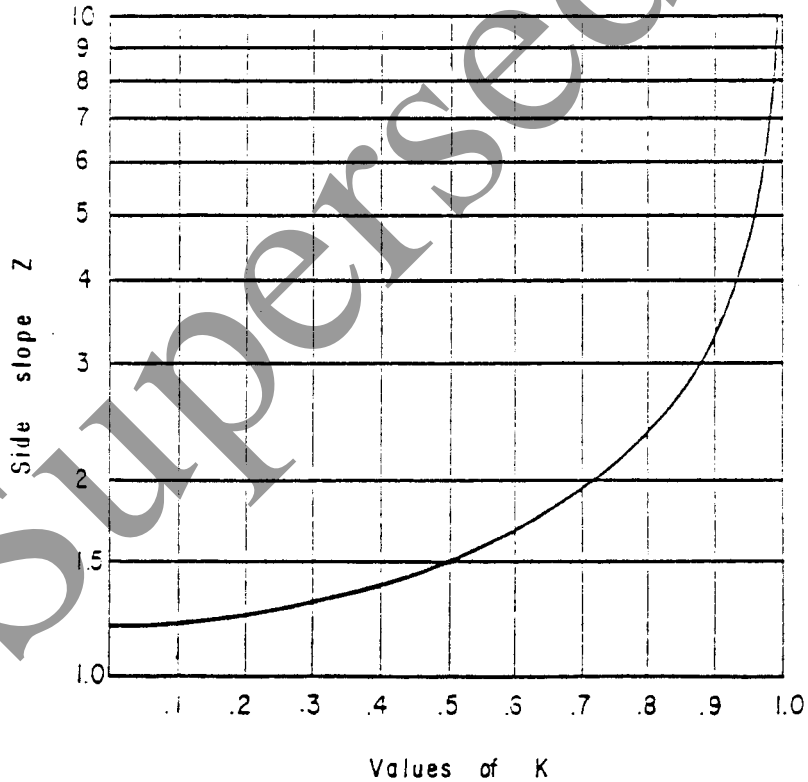

CURVE 2.12-6

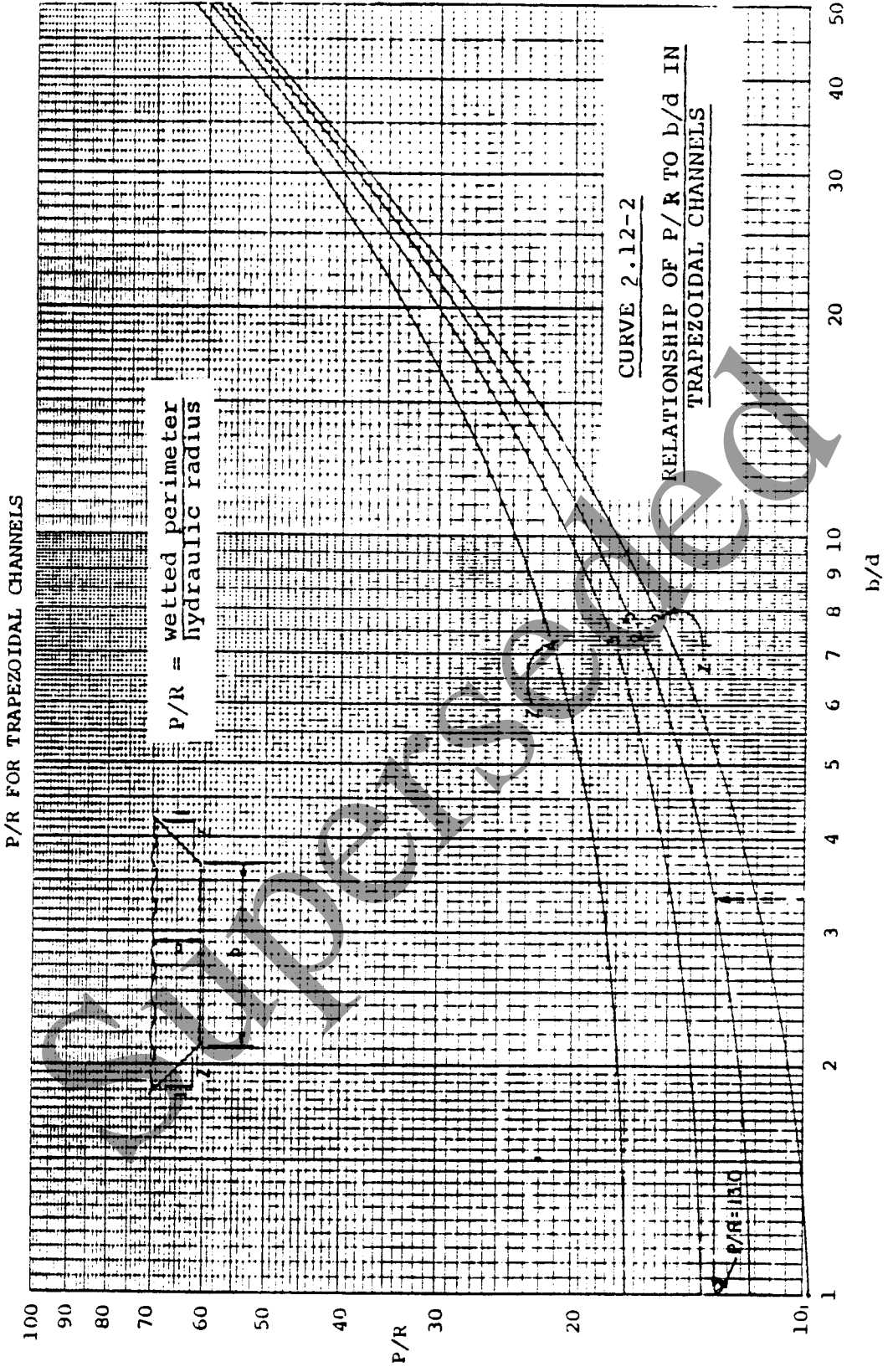

MEDIAN RIPRAP DIAMETER FOR STRAIGHT TRAPEZOIDAL CHANNELS

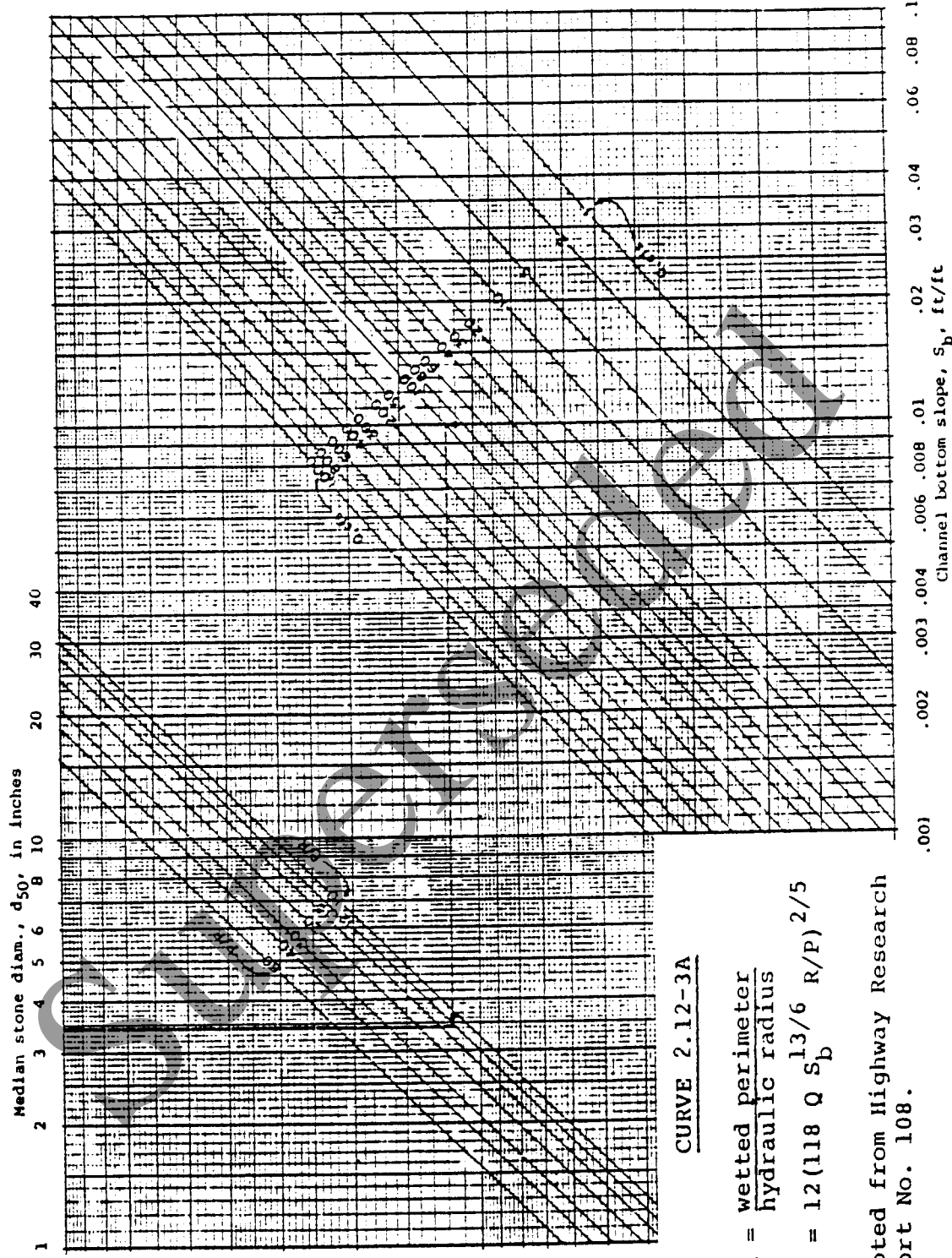

CURVE 2.12-3A

$P/R = \frac{\text{wetted perimeter}}{\text{hydraulic radius}}$

$$d_{50} = 12(118 Q S_b^{13/6} R/P)^{2/5}$$

Adapted from Highway Research Report No. 108.

MEDIAN RIPRAP DIAMETER FOR STRAIGHT TRIANGULAR CHANNELS

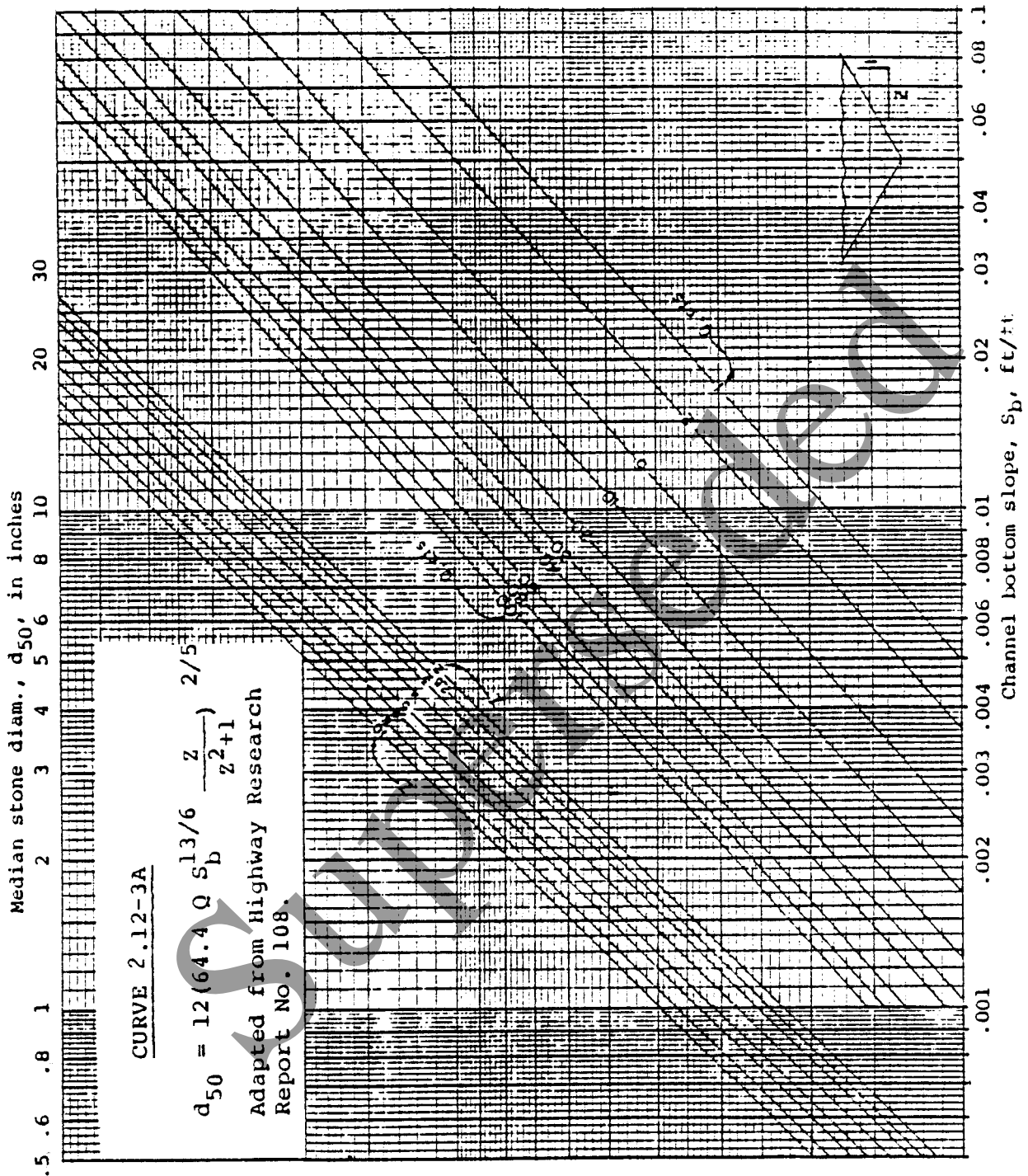

CURVE 2.12-4

RIPRAP SIZE CORRECTION FACTOR FOR FLOW IN CHANNEL BENDS

$d_{50}(\text{for bend}) = d_{50}(\text{for straight}) \times F_B$
 B_s = channel surface width
 R_0 = mean radius of bend

Adapted from Highway Research Report No. 108.

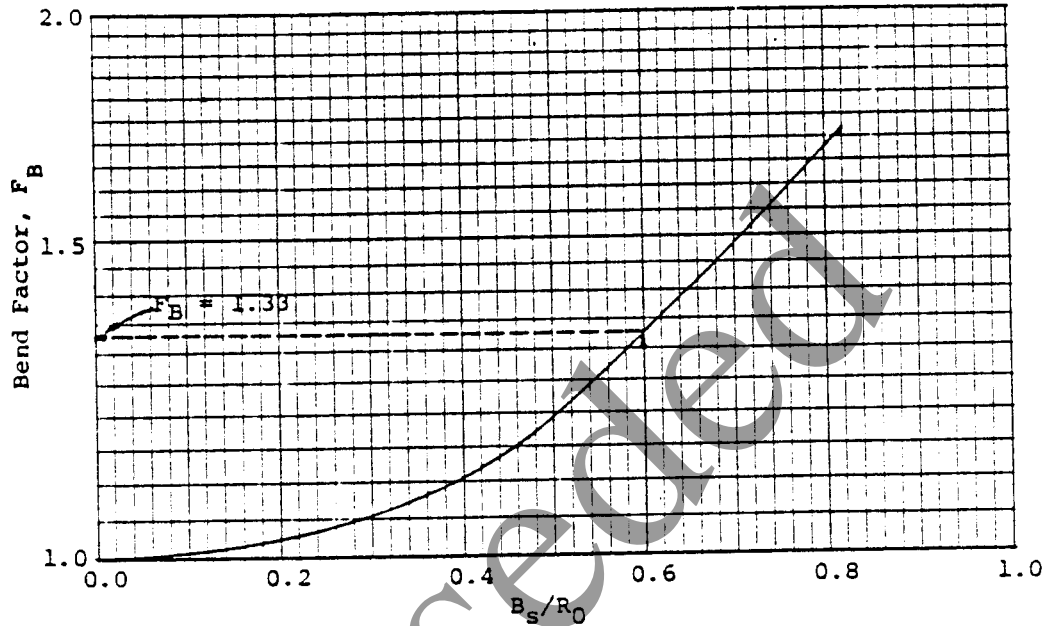

CURVE 2.12-5

MAXIMUM RIPRAP SIDE SLOPE WITH RESPECT TO RIPRAP SIZE

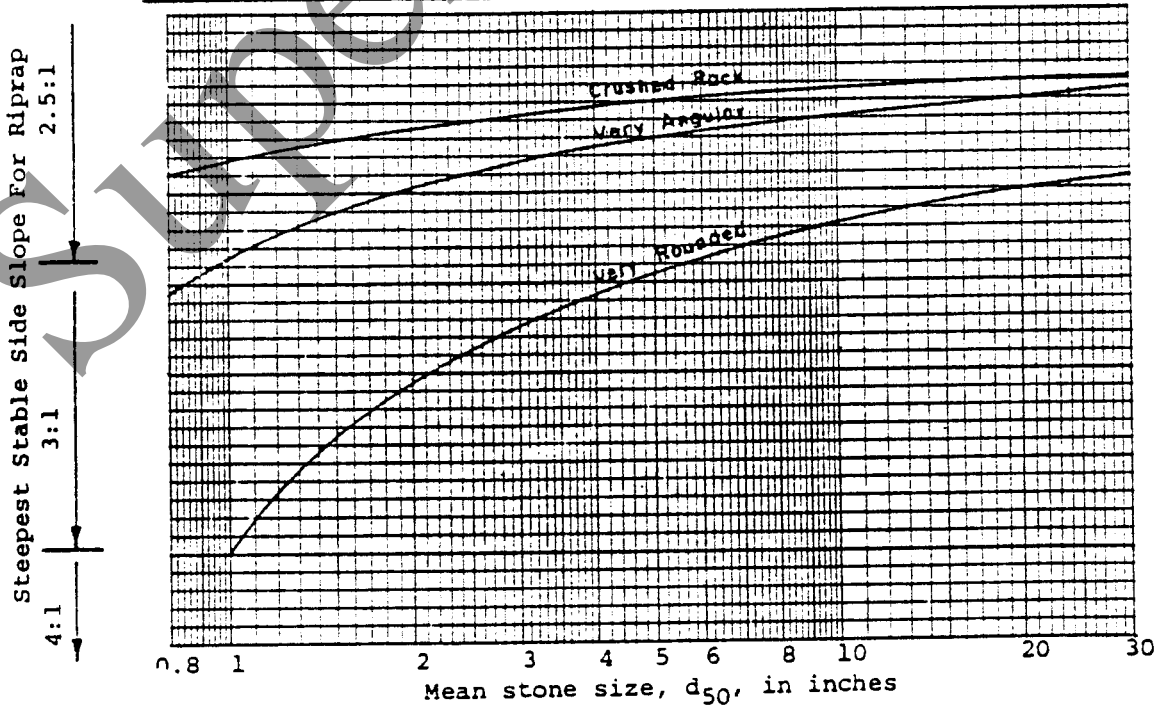

STANDARD
FOR
SEDIMENT BARRIER

Definition

A temporary barrier installed across or at the toe of a slope.

Purpose

The purpose of a sediment barrier is to intercept and detain small amounts of sediment from unprotected areas of limited extent.

Conditions Where Practice Applies

The sediment barrier is used where:

1. No other practice is feasible,
2. There is no concentration of water in a channel or other drainageway above the barrier, and
3. Erosion would occur in the form of sheet and rill erosion.

Design Criteria

- A. All types of sediment barriers:
 1. Contributing drainage area is less than 1 acre and the length of slope above the barrier is less than 150 feet.
 2. The slope of the contributing drainage area for at least 30 feet adjacent to the barrier shall not exceed 5%.
 3. The barrier shall be constructed so water cannot bypass the barrier around the ends.
 4. Inspection shall be frequent and repair or replacement shall be made promptly as needed.
 5. The barrier shall be removed when it has served its usefulness so as not to block or impede storm flow or drainage.
- B. Requirements for bale barrier (e.g., straw, hay, or other acceptable vegetative material):
 1. All bales shall be securely tied and staked on the contour. See Figure 2.13-I for details.
 2. Bales shall be placed in a row with ends tightly abutting the adjacent bales.

3. Each bale shall be embedded in the soil a minimum of 4 inches.
4. Bales shall be securely anchored in place by two stakes or re-bars driven through each bale. The first stake in each bale shall be driven toward previously laid bale to force bales together.

C. Requirements for silt fence:

1. Fence posts shall be spaced 8 feet center-to-center or closer. They shall extend at least 2 feet into the ground. They shall extend at least 2 feet above ground.
2. A metal fence with 6 inch or smaller openings and at least 2 feet high may be utilized, fastened to the fence posts.
3. A filter fabric, recommended for such use by the manufacturer, shall be buried at least 6 inches deep in the ground. The filter fabric shall extend at least 2 feet above the ground. Filter fabric may be fastened in place by stake or other accepted means as specified by the district office.

D. Requirements for stone barrier:

1. The stone shall be piled to a natural angle of repose with a height of at least 2 feet.
2. The stone shall meet ASTM C-33 size No. 2 or 3.

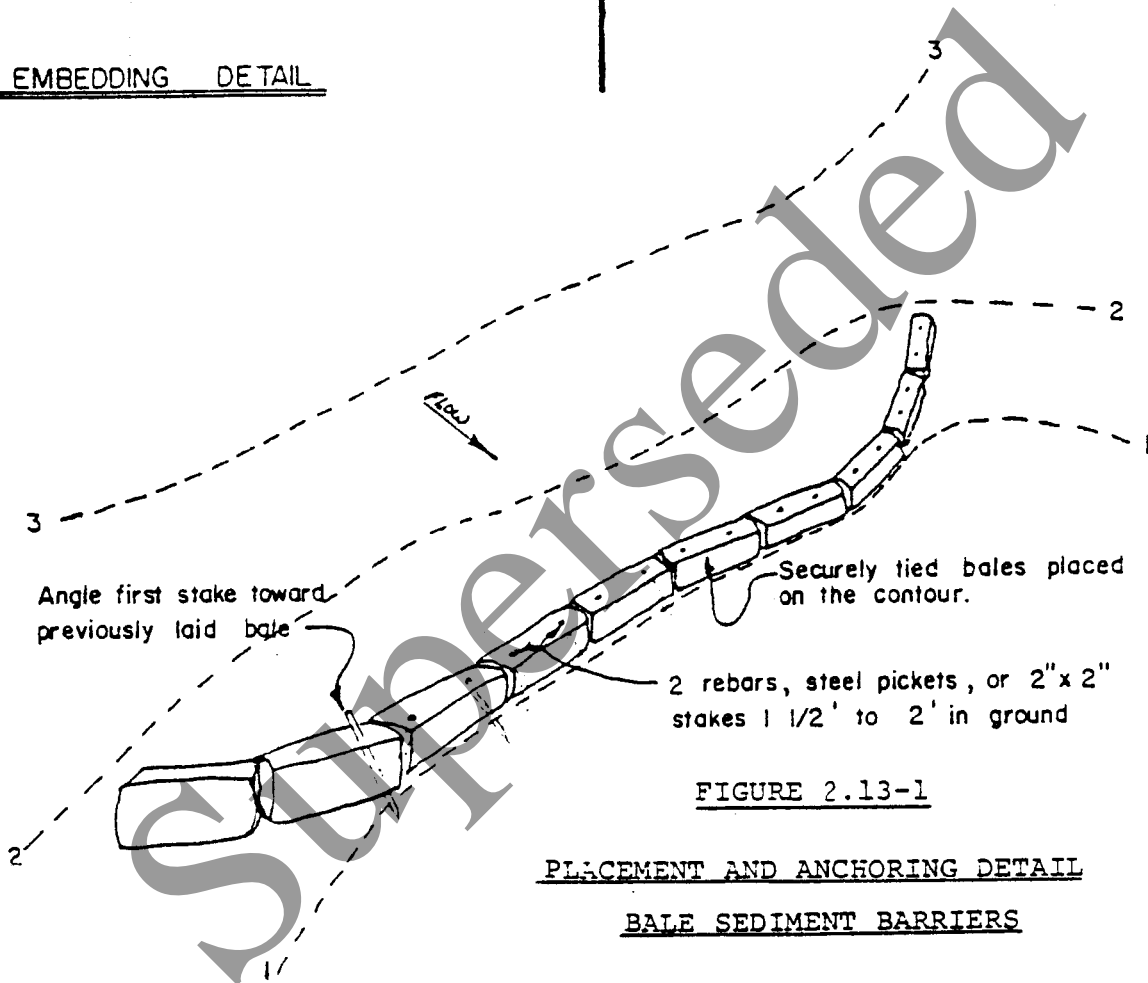
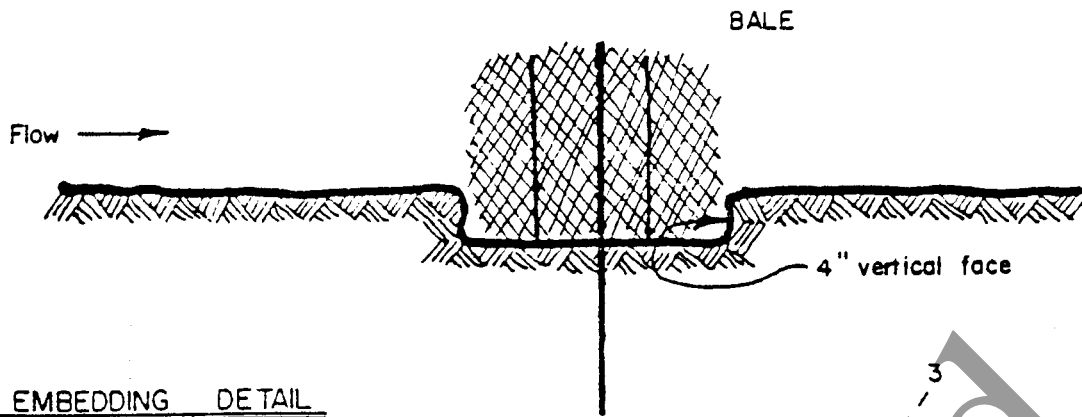
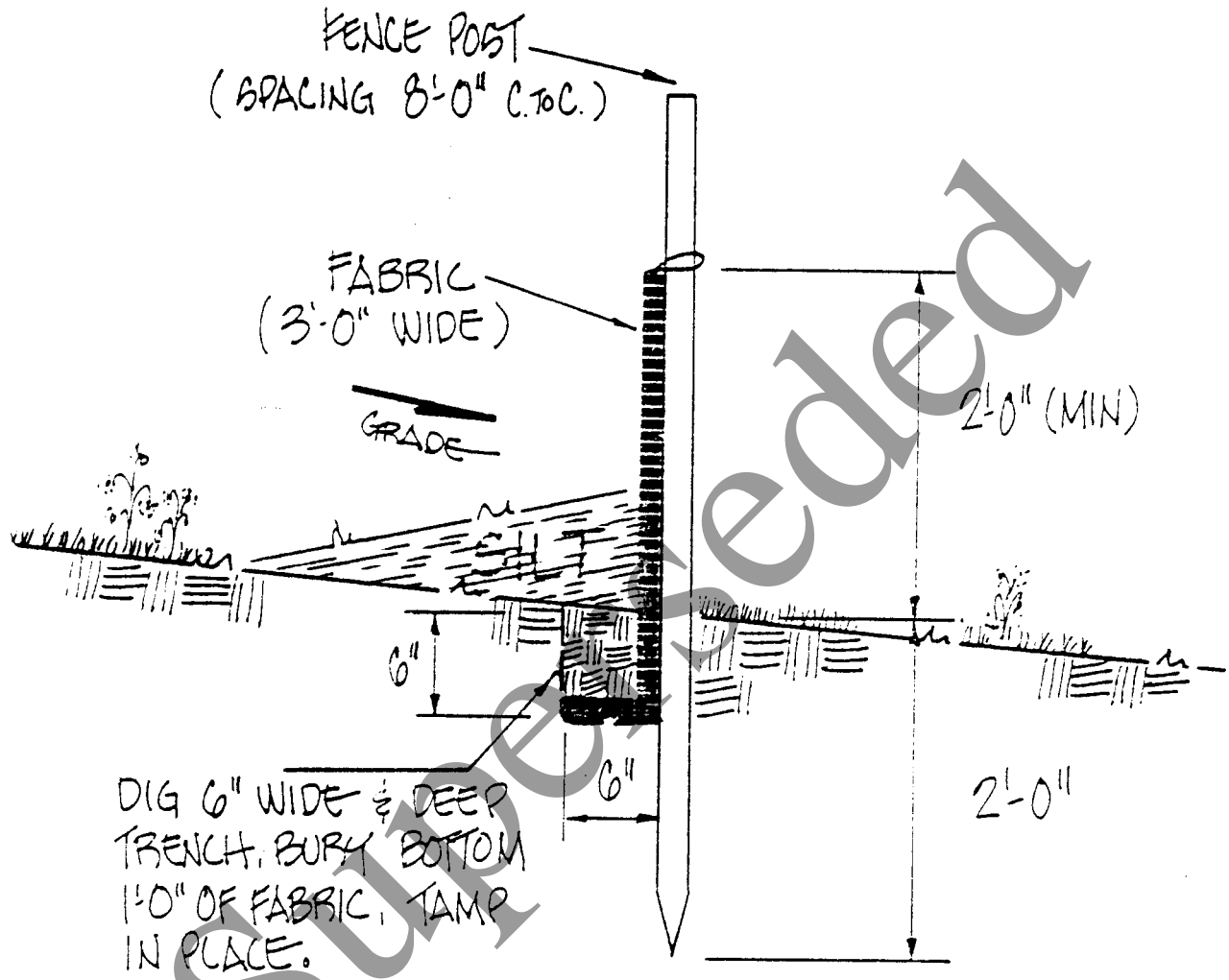
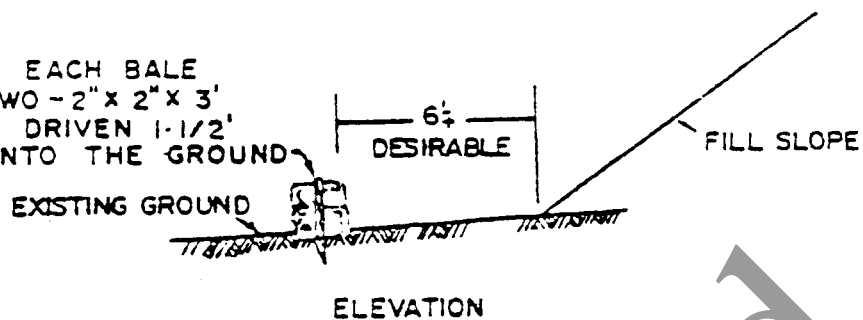

Figure 2.13-2



SILT FENCE DETAIL

ANCHOR EACH BALE WITH TWO - 2" x 2" x 3' STAKES DRIVEN 1-1/2' TO 2' INTO THE GROUND



NOTE: EMBED BALES 4 TO 6 INCHES AND ANGLE FIRST STAKE TOWARDS PREVIOUSLY LAID BALE.

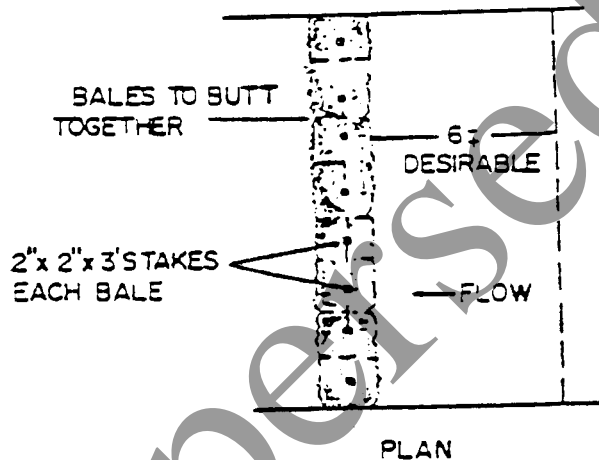

NOTE: TO BE USED WHERE THE EXISTING GROUND SLOPES AWAY FROM THE HIGHWAY EMBANKMENT AS CALLED FOR ON PLANS.

MEASUREMENT AND PAYMENT WILL BE BY THE BALE IN PLACE. BALES WILL BE ALLOWED TO ROT IN PLACE SO THERE WILL BE NO REMOVAL ITEM. THERE WILL BE NO PROVISIONS FOR MAINTENANCE OTHER THAN REPLACEMENT OF A BALE IF REQUIRED.

BALED HAY EROSION CHECKS

Figure 2.13-3

Superseded

STANDARD
FOR
CONDUIT OUTLET PROTECTION

Definition

Conduit Outlet Protection consists of an erosion resistant section between a conduit outlet and a stable downstream channel.

Purpose

To provide a stable area at the outlet of a conduit in which the exit velocity from the conduit is reduced to a velocity consistent with a stable condition in the downstream channel.

Conditions Where Practice Applies

This practice applies to all conduit outlets.

Design Criteria

Determination of Needs

The need for conduit outlet protection shall be determined by comparing the allowable velocity for the soil onto which the conduit is discharging to the velocity in the conduit. The allowable velocity for the soil shall be that given in Table 2-14-1. The velocity in the conduit shall be that which occurs during passage of the conduit design storm or the 25-year frequency storm, whichever is greater. When the velocity in the conduit exceeds the allowable velocity for the soil, conduit outlet protection will be used.

TABLE 2-14-1

ALLOWABLE VELOCITIES FOR VARIOUS SOILS

SOIL TEXTURE	ALLOWABLE VELOCITY (ft./sec.)
Sand	1.75
Sandy loam	2.5
Silt loam (also high lime clay)	3.0
Sandy clay loam	3.5
Clay loam	4.0
Clay, fine gravel, graded loam to gravel	5.0
Cobbles	5.5
Shale (non-weathered)	6.0

A. Horizontal Riprap Apron

Apron Dimensions

1. The length of the apron, L_a , shall be determined from the formula:

$$L_a = \frac{1.8 Q}{D_o^{3/2}} + 7 D_o \quad TW < \frac{1}{2} D_o$$

$$L_a = \frac{3 Q}{D_o^{3/2}} \quad TW \geq \frac{1}{2} D_o$$

Where D_o is the maximum inside culvert width in feet, Q is the pipe discharge in cfs for the conduit design storm or the 25 year storm, whichever is greater.

2. Where there is no well-defined channel immediately downstream of the apron, the width, W , of the outlet end of the apron shall be as follows:

For tailwater elevation greater than or equal to the elevation of the center of the pipe, $W = 3 D_o + 0.4 L_a$.

For tailwater elevation less than the elevation of the center of the pipe, $W = 3 D_o + L_a$.

Where L_a is the length of the apron determined from the formula and D_o is the culvert width.

The width of the apron at the culvert outlet shall be at least 3 times the culvert width.

3. Where there is a well-defined channel downstream of the apron, the bottom width of the apron shall be at least equal to the bottom width of the channel; and the structural lining shall extend at least one foot above the tailwater elevation but no lower than two-thirds of the vertical conduit dimension above the conduit invert.
4. The side slopes shall be 2:1 or flatter.
5. The bottom grade shall be 0.0% (level).
6. There shall be no overfall at the end of the apron or at the end of the culvert.

B. Riprap

1. The median stone diameter, d_{50} , in feet, shall be determined from the formula:

For Horizontal Apron:
$$d_{50} = \frac{0.02}{TW} \left(\frac{Q}{D_o} \right)^{4/3}$$

For areas where TW cannot be computed, use $TW = 0.2 D_o$

Where Q and D_o are as defined under apron dimensions and TW is tailwater depth above the invert of culvert in feet.

Preformed Scour Hole

Preformed scour holes may be utilized, as depicted in Figure 14.14-4, where conditions dictate the impractical use of flat aprons. The median stone diameter, d_{50} , in feet, shall be determined from the following formulas:

$$d_{50} = \frac{0.0125}{TW} \left(\frac{Q}{D_o} \right)^{4/3} \quad \text{where } Y = \frac{1}{2} D_o$$

$$d_{50} = \frac{0.0082}{TW} \left(\frac{Q}{D_o} \right)^{4/3} \quad \text{where } Y = D_o$$

Y = depth of scour hole below culvert invert

The use of scour holes shall comply with county or local ordinances which would restrict the use of such devices due to possible problems with mosquito breeding.

Downstream Protection

The conduit discharge shall not cause erosion in the downstream channel, or aggravate conditions in the downstream channel. The designer shall furnish calculations to show that the conditions downstream will not be degraded as a result of the proposed construction.

Riprap Requirements

1. Fifty percent, by weight, of the riprap mixture shall be smaller than the median size stone designated as d_{50} . The largest stone size in the mixture shall be 1.5 times the d_{50} size. The riprap shall be reasonably well graded.
2. The thickness of riprap lining, filter, and quality shall meet the requirements in the riprap standard (pp. 2-12-1 - 2-12-14).
3. Properly designed concrete paving may be substituted for riprap.
4. Gabions or concrete revetment blocks may be substituted for riprap if the d_{50} size calculated above is less than or equal to the thickness of the gabions or concrete revetment blocks. Design life of gabions is

estimated to be ten (10) years. Gabions shall be filled with 4" to 7" angular shaped rock.

Installation Requirements

1. No bends or curves at the intersection of the conduit and apron, or scour hole, will be permitted.
2. There shall be no overfall from the end of the apron to the receiving channel.

Superseded

References

Fletcher, B. P. and Grace, J. S. Jr., PRACTICAL GUIDANCE FOR ESTIMATING AND CONTROLLING EROSION AT CULVERT OUTLETS, 1972, Corps of Engineers Research Report H-72-5, Waterways Experiment Station, Vicksburg, Mississippi.

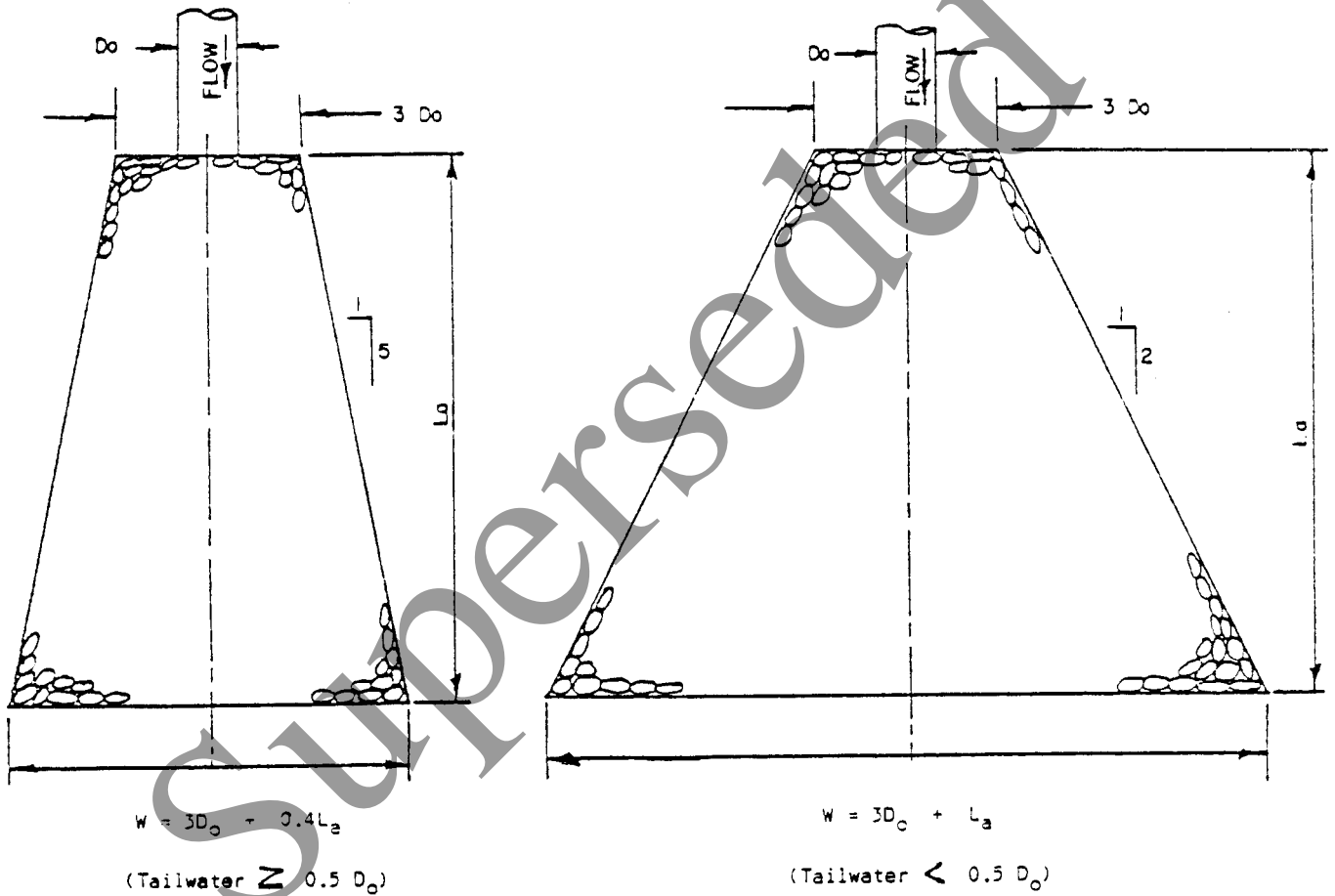

CONFIGURATION OF CONDUIT OUTLET PROTECTION

GUIDANCE FOR MULTIPLE CULVERT OUTLETS

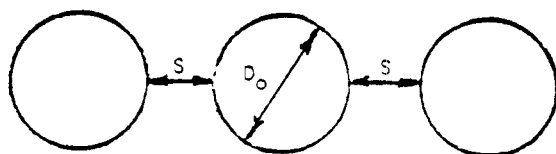

All Culverts
Same Diameter
Discharging Same Q

FOR $S < \frac{1}{2}D_o$

Size Riprap & Length For 1 Pipe
Width shall accommodate all culverts

FOR $S \geq \frac{1}{2}D_o$

Size Riprap & Length For 1 Pipe
and increase values by 25%

For culverts of varying diameters or discharge check riprap size and apron length for each. Use the largest values. Increase length and riprap values by 25% if spacing is greater than $\frac{1}{2}D_o$. Width shall accommodate all culverts.

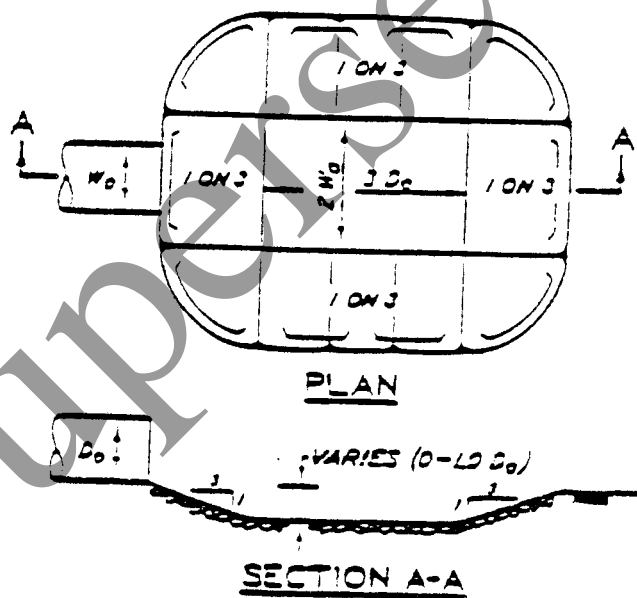

PREFORMED SCOUR HOLE

STANDARD
FOR
STABILIZED CONSTRUCTION ENTRANCE

Definition

A stabilized pad of crushed stone located at points where traffic will be entering or leaving a construction site.

Purpose

The purpose of a stabilized construction entrance is to reduce the tracking or flowing of sediment onto public right-of-ways.

Conditions Where Practice Applies

A stabilized construction entrance applies to points of construction ingress and egress where sediment may be tracked, or flow off, the construction site.

Design Criteria

Stone Size - Use ASTM C-33, size No. 2 or 3. Use crushed stone.

Thickness - not less than six (6) inches.

Width - not less than full width of points of ingress or egress.

Length - 50 feet minimum where the soils are sands or gravels or 100 feet minimum where soils are clays or silts, except where the traveled length is less than 50 or 100 feet respectively. These lengths may be increased where field conditions dictate.

At poorly drained locations, subsurface drainage gravel filter or filter fabric shall be installed before installing the stabilized construction entrance.

Maintenance

The entrance shall be maintained in a condition which will prevent tracking or flowing of sediment onto public rights-of-way. This may require periodic top dressing with additional stone or additional length as conditions demand and repair and/or cleanout of any measures used to trap sediment. All sediment spilled, dropped, washed, or tracked onto public right-of-ways must be removed immediately.

TABLE Grading Requirements for Coarse Aggregates

Size Number	Nominal Size (Sieves with Square Openings)	Amounts Finer than Each Laboratory Sieve (Square-Openings), Weight Percent											
		100 mm (4 in.)	90 mm (3½ in.)	75 mm (3 in.)	63 mm (2½ in.)	50 mm (2 in.)	37.5 mm (1½ in.)	25.0 mm (1 in.)	19.0 mm (¾ in.)	12.5 mm (½ in.)	9.5 mm (¾ in.)	4.75 mm (No. 4)	2.36 mm (No. 8)
2	63 to 37.5 mm (2½ to 1½ in.)	100	90 to 100	35 to 70	0 to 15	...	0 to 5
3	50 to 25.0 mm (2 to 1 in.)	100	90 to 100	35 to 70	0 to 15	...	0 to 5

Figure 2.15-1

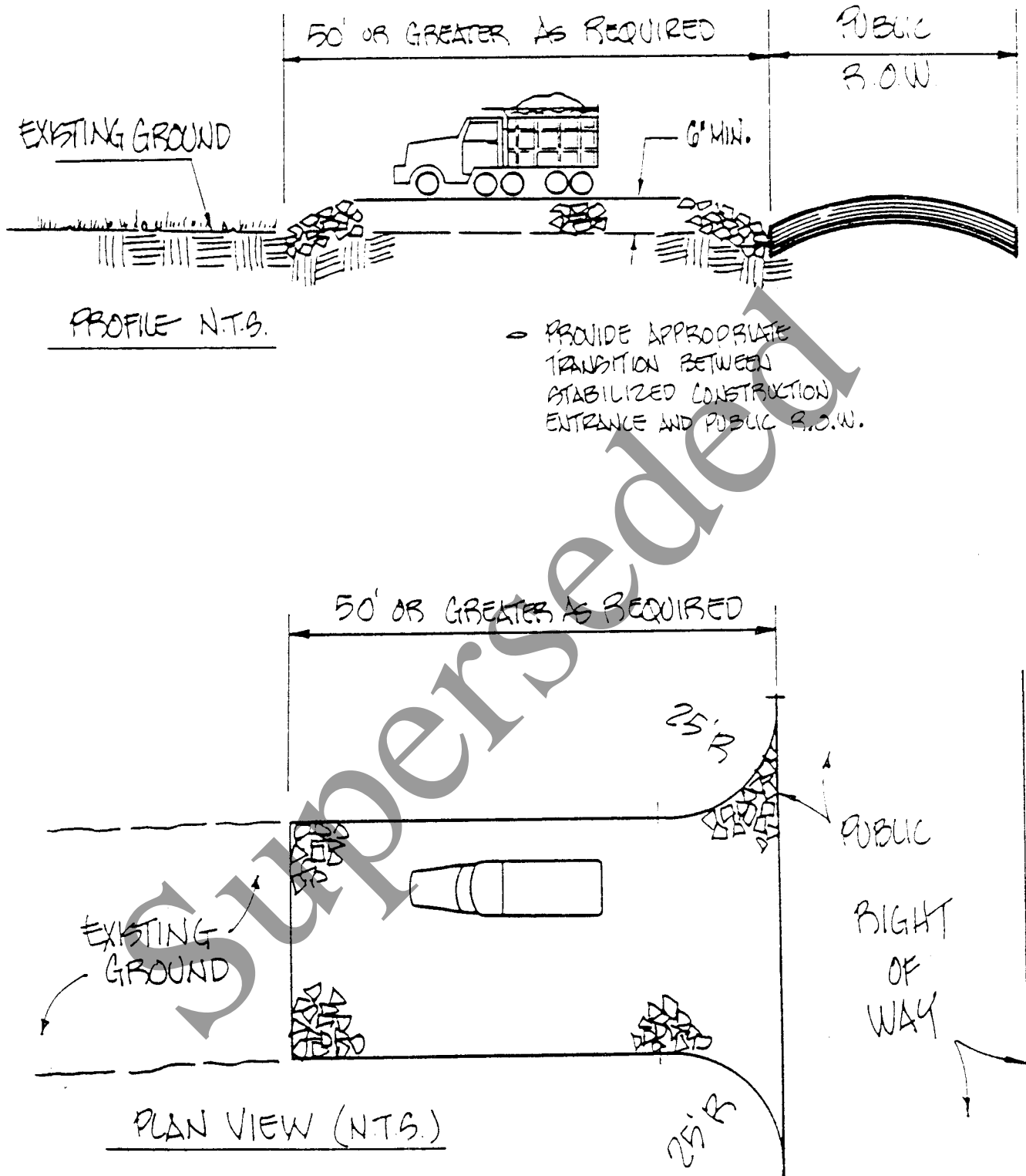

STABILIZED CONSTRUCTION ENTRANCE

STANDARD
FOR
STORM SEWER INLET PROTECTION

Definition

A temporary barrier and settling facility installed at a storm sewer inlet.

Purpose

The purpose of storm sewer inlet protection is to intercept and retain sediment, thus preventing the entrance of sediment into the storm sewer system.

Conditions Where Practice Applies

1. Contributing drainage area is 3 acres or less.
2. A storm sewer or the outlet channel of a storm sewer needs protection from sediment.
3. Traffic will not destroy or cause constant maintenance of the storm sewer inlet protection.
4. A traffic hazard will not be created.

Design Criteria

A. General - All types of storm sewer inlet protection:

1. Must slow the storm water, provide the coarse sediment particles a chance to settle, and provide an area to retain the particles that have settled; or
2. Must prevent the storm water from entering the catch basin inlet.

The following sections provide three methods. Other methods that accomplish the purpose of storm sewer inlet protection may be used if approved by the Soil Conservation District.

Inspections shall be frequent. Maintenance, repair, and replacement shall be made promptly, as needed.

The barrier shall be removed when the area draining toward the inlet has been stabilized.

B. Blocked Inlet - Catch basin inlets may be blocked until the area draining toward the catch basin is permanently protected from erosion when:

1. The material used to block the inlet is prevented from floating or being carried into the inlet and;

2. An erosion or a flooding problem is not caused by blocking the inlet.

C. Protected Inlet:

1. The perimeter length of the barrier shall be at least four times the perimeter length of the storm sewer inlet. The top of the barrier shall be level and uniform for at least this length.
2. The barrier shall encircle the inlet.
3. If bales (straw, hay or other acceptable vegetative materials) are used for the barrier, they shall be staked down in accordance with the sediment barrier standard. Where staking is not practical, they shall be tied together to prevent movement or openings in the barrier.
4. If gravel is used for the barrier, it shall be piled at least 1 1/2 feet high to its natural angle of repose. The gravel shall meet size no. 2 or 3 in ASTM C-33.

D. Inlet with Sediment Trap:

1. A screen is placed completely over the inlet.
2. A sturdy protective frame is placed around the inlet and filled with ASTM C-33 size no. 2 or 3 stone.
3. A sediment trap is excavated behind the curb at the inlet. The basin shall be at least 12 to 14 inches in depth, approximately 36 inches in width, and approximately 7 to 10 feet in length parallel to the curb.
4. Storm water will reach the sediment trap via curb cuts adjacent to each side of the inlet structure. These openings shall be at least 12 inches in length. Storm water may also reach the basin via overland flow from land area behind the curb. The curb cuts shall be repaired when the sediment trap is removed.

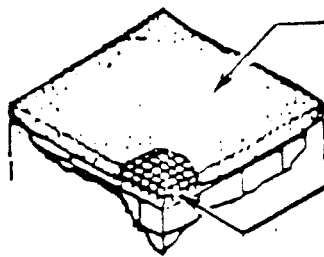

INLET FILTER INSTALLATION
WITHOUT FRAME AND GRATE

WIRE SUPPORT - MOULD 6x6", 5/8 GA. 49 #/100 SQ. FT.
WELDED WIRE SUPPORT. EXTEND 6" MIN. AT SIDES

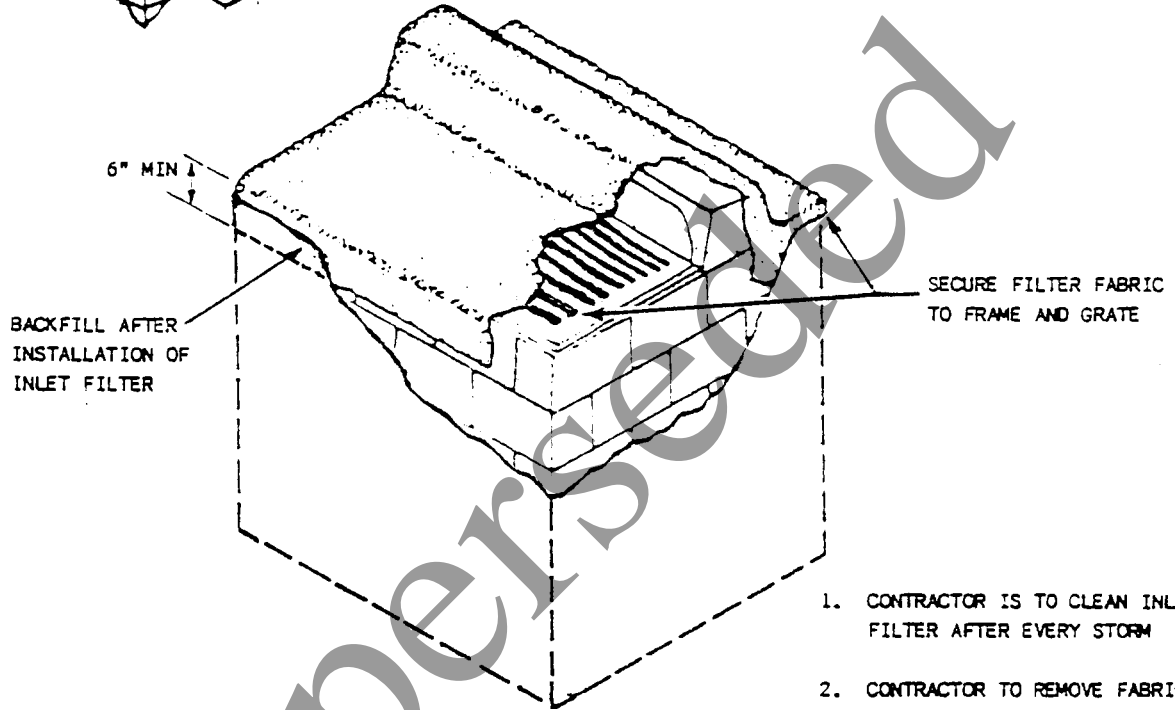

6" MIN

BACKFILL AFTER
INSTALLATION OF
INLET FILTER

SECURE FILTER FABRIC
TO FRAME AND GRATE

1. CONTRACTOR IS TO CLEAN INLET
FILTER AFTER EVERY STORM
2. CONTRACTOR TO REMOVE FABRIC
JUST PRIOR TO PAVING

INLET FILTER DETAIL

N.T.S.

Gravel Curb Inlet Sediment Filter

- A. Hardware cloth, or comparable wire mesh, with $\frac{1}{2}$ openings shall be placed over the curb inlet opening so that at least 12 inches of wire extends across the inlet cover and at least 12 inches of wire extends across the concrete gutter from the inlet opening, as illustrated.
- B. Stone shall be piled against the wire so as to anchor it against the gutter and inlet cover and to cover the inlet opening completely. Two (2) to three (3) inch coarse aggregate shall be used.
- C. If the stone filter becomes clogged with sediment so that it no longer adequately performs its function, the stone must be pulled away from the inlet, cleaned and replaced.

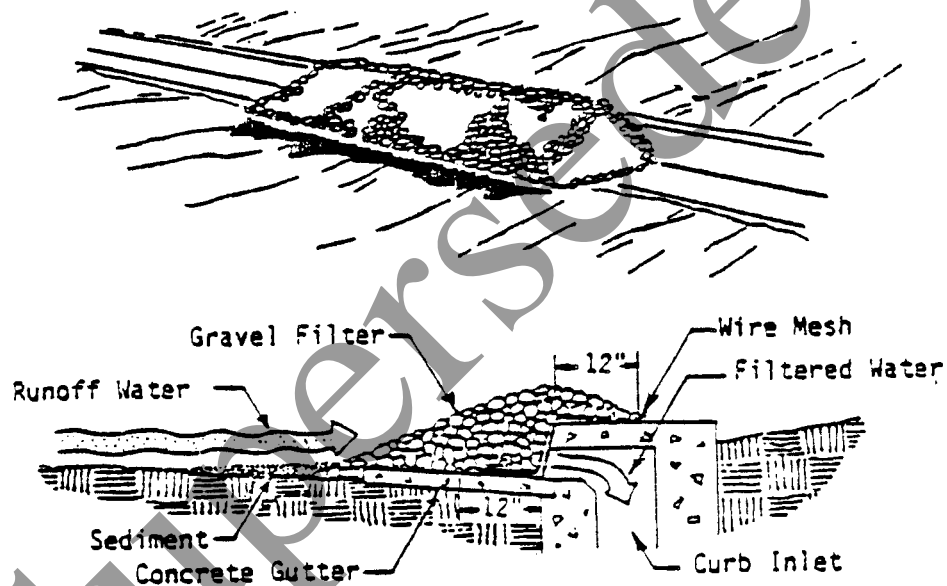

Specific Application

This method of inlet protection is applicable at curb inlets where ponding in front of the structure is not likely to cause inconvenience or damage to adjacent structures and unprotected areas.

Gravel Curb Inlet Sediment Filter

STANDARD
FOR

GRADE STABILIZATION STRUCTURE

Definition

A structure (drop, chute, etc) to control the grade and head cutting in natural or artificial channels.

Scope

This standard applies to all types of grade stabilization structures. It also applies to structures installed to lower the water from a surface drain or a waterway to a deeper channel to control erosion, head cutting, or channel grade. It does not apply to structures designed to control the rate of flow or to regulate the water level in channels.

Purpose

To stabilize the grade and control erosion in natural or artificial channels, to prevent the formation or advance of gullies, and to reduce environmental and pollution hazards.

Conditions Where Practice Applies

This standard applies to areas where the concentration and flow velocity of water requires structures to stabilize the grade, or to control gully erosion in channels. Special attention shall be given to maintaining or improving habitat for fish and wildlife and to maintaining or improving the natural stream flow characteristics, where applicable.

Design CriteriaStructures

The structure must be designed so that it is stable after installation. The crest of the inlet must be set at an elevation that stabilizes the upstream channel. The outlet must be set at an elevation level that results in a stable structure. Structures must not create unstable conditions upstream or downstream.

Structure Embankments

Embankments used with structures must meet the following requirements:

Foundation - The area on which an embankment is to be placed shall consist of material that has sufficient bearing strength to support the embankment without excessive consolidation.

Top width - The minimum top width shall be as follows:

TOTAL HEIGHT OF EMBANKMENT (feet)	TOP WIDTH (feet)
up to 20	10
20 - 24	12

Side slopes - The combined upstream and downstream side slopes of the settled embankment shall not be less than five horizontal to one vertical, with neither slope steeper than 2:1. Slopes must be designed to be stable in all cases, even if flatter side slopes are required.

Freeboard - The minimum elevation of the top of the settled embankment shall be 1.0 feet above the maximum water surface upstream during the total capacity design storm.

Settlement - The design height of the embankment shall be increased by the amount needed to insure that after all settlement has taken place, the height of the embankment will equal or exceed the design height. This increase shall not be less than 5%, except where detailed soil testing and laboratory analysis shows a lesser amount is adequate.

Length - If natural ground elevation is used for an emergency spillway, the constructed top elevation of the embankment shall extend at least 40 feet on both sides of the structure.

Structure Spillways

Chute and drop spillways shall be designed according to the principles set forth in the Engineering Field Manual for Conservation Practices, The National Engineering Handbook, and other applicable SCS publications and reports. The minimum capacity shall be that required to pass the peak flow expected from a design storm of the frequency and duration shown in Table 2-17-1 or 2-17-2, as applicable, less any reduction because of detention storage.

Full flow structures are structures where the structure spillway plus an emergency spillway, if used, carry all the flow from the watershed. Typical full flow structures are drop spillways and rock chutes.

Island structures are structures where flows larger than the structure spillway design flow spread out, and the larger flows are not significantly carried by the structure spillway. Typical island structures are pipe drop and hooded inlets.

TABLE 2-17-1

MINIMUM CAPACITY OF FULL-FLOW STRUCTURES

DRAINAGE AREA (acre)	VERTICAL DROP (feet)	MINIMUM DESIGN STORM		
		STRUCTURE SPILLWAY CAPACITY FREQUENCY (year)	TOTAL CAPACITY FREQUENCY (year)	MINIMUM DURATION (hour)
250 or less	5 or less	5	10	24
500 or less	10 or less	10	25	24
all other	all other	25	100	24

TABLE 2-17-2

MINIMUM CAPACITY OF ISLAND STRUCTURES

DRAINAGE AREA (acre)	VERTICAL DROP (feet)	MINIMUM DESIGN STORM		
		STRUCTURE SPILLWAY CAPACITY* (year)	TOTAL CAPACITY FREQUENCY (year)	MINIMUM DURATION (hour)
250 or less	5 or less	1	10	24
500 or less	10 or less	1	25	24
all other		1 year or channel design capacity, whichever is higher	50	24

Total Capacity Design Storm

All structures shall have the capacity to pass the peak flow expected from the minimum design storm for total capacity in Tables 2-17-1 and 2-17-2, as applicable, less any reduction because of detention storage. This may be accomplished by using a structure spillway or a combination of structure spillway and emergency spillway. There shall not be damage to, or erosion of the structure spillway or emergency spillway during passage of the total capacity design storm. Water flowing through an emergency spillway during the total capacity design storm must re-enter the channel without erosion.

Emergency spillways may use natural ground or be constructed. Minimum design flow depth for natural ground emergency spillways is 0.3 feet.

Toe Wall Drop Structures

Toe wall drop structures may be used if the vertical drop is 4 feet or less, flows are intermittent, and downstream grades are stable.

Road Culvert Box Inlets

The minimum capacity of drop boxes to culverts shall be as specified in Tables 2-17-1 or 2-17-2, as applicable, or as required by the responsible road authority, whichever is greater.

Superseded

STANDARD
FOR
PARKING LOT STORAGE

Definition

The temporary storage of runoff on a parking lot.

Purpose

Parking lot storage is used to reduce erosion and downstream flooding by temporary storage of runoff.

Conditions Where Practice Applies

This practice applies if there is increased downstream erosion due to construction at development sites, or from other land use changes. The increased downstream erosion may be caused by such factors as increased runoff volume, increased peak discharge, reduced time of concentration, or reduced natural storage.

Design Criteria

General

Parking lot storage areas can be used to control runoff from paved areas. Most parking lot storage areas include small ponding areas that have an increased curb height, an outlet control structure, and an emergency overflow. This practice generally is used to control runoff from areas less than 3 acres in size. The parking lot design and installation grades must insure positive flow to the storage area. The storage area must be nearly level, but the slope must be steep enough to facilitate drainage. Positive drainage must be provided to prevent frost damage. Trash guards must be provided to prevent clogging of the outlet control structure. Generally, ponding on the parking lot must not exceed 6 inches in areas where cars and light trucks are to be parked, or 10 inches where heavy trucks are to be parked. Emergency overflow outlets must be provided. Such auxiliary practices as porous pavement and vegetative strips may be used in or adjacent to parking lots to permit infiltration.

Design Storms

The peak discharge from the 2-year and 10-year frequency storms shall be analyzed. No increase in peak discharge from these two storms, caused by construction operations or changes in land use, shall be allowed unless the increase in peak discharge does not result in increased potential for erosion.

Some of the items to be considered in determining if there is an increased potential for downstream erosion are:

1. the timing of peak flows from subwatersheds;
2. the increased duration of large flows;
3. the stability of the downstream areas;
4. the distance downstream that the peak discharges are increased.

If there is an overall flood plain management system that considers erosion, downstream peak flow increases that are compatible with the overall flood plain management system may be allowed.

Outlet Control Structure Capacity

The minimum pipe size shall be 6 inches. The outlet control structures and the temporary flood storage below the emergency overflow must handle the runoff from the design storms without flow through the emergency overflow. Flood routing shall be done using the approximate methods in the Soil Conservation Service Engineering Field Manual, the Soil Conservation Technical Release 55 (TR55), modified rational method as described in Special Report 43 by the American Public Works Association, Practices in Detention of Urban Stormwater, or other generally accepted methods of flood routing.

Ownership

Ownership and responsibility for operation and maintenance of the parking lot storage, after the site is completed, must be determined during design. To be effective over a long period of time, parking lot storage must be properly maintained. Parking lot storage should normally be owned by a unit of government that accepts responsibility for the parking lot storage, and can obtain the money necessary for operation and maintenance work.

If the parking lot storage is not owned by a unit of government, there should be a legally binding and easily enforceable document requiring the owner to operate and maintain the parking lot storage so that the benefits to the public of installing the parking lot storage are received over its intended life.

Operation and Maintenance

A plan of operation and maintenance shall be prepared for use by the owner or others responsible for parking lot storage to insure that it functions properly. This plan shall provide requirements for inspection, operation, and maintenance of the parking lot storage, including outlets. It shall be prepared during design and shall specify who is responsible for maintenance. Adequate access must be provided for maintenance.

Outlet Capacity

The minimum outlet pipe size shall be 5 inches. The outlet and temporary storage in the tank must handle the runoff from the design flood. Flood routing may be done using the approximate methods in the Soil Conservation Service Engineering Field Manual, the Soil Conservation Service Technical Release 55 (TR55), modified rational or other general methods of flood routing. The maximum time of storage shall not exceed 30 days.

General

In acid or sulfidic soils, tank materials shall be nonreactive with the soil or measures shall be taken to protect the tank from the soil. Provisions shall be made to prevent debris from entering the tank. Debris collectors shall be placed so that the need for maintenance can be easily detected and cleaning operations easily performed. The bottom of the tank shall be on a slight grade to insure complete drainage of the tank. A manhole must be provided to the tank to permit removal of sediment and debris.

Ownership

Ownership and responsibility for operation and maintenance of the underground tank, after the site is completed, must be determined at the design stage. To be effective over a long period of time, the underground tank must be properly maintained. Tanks should normally be owned by a unit of government that accepts responsibility for the tank and can obtain the money necessary to do operation and maintenance work. If the underground tank is not owned by a unit of government, there should be a legally binding and easily enforceable document requiring the owner to maintain the tank so that the benefits to the public of installation are received over its intended life.

Operation and Maintenance

A plan of operation and maintenance shall be prepared for use by the owner or others responsible for the underground tank to insure that it is properly maintained. This plan shall provide requirements for inspection, and maintenance of the tank, including outlets. It shall be prepared during design and shall specify who is responsible for maintenance. Adequate access must be provided for maintenance.

Underground Tanks

STANDARD
FOR
UNDERGROUND TANKS

Definition

The temporary storage of runoff in a buried structure.

Purpose

Underground tanks are used to reduce downstream erosion and flooding by temporary storage of runoff.

Conditions Where Practice Applies

This practice applies if there is increased downstream erosion due to construction at development sites or from other land use changes. The increased downstream erosion may be caused by such factors as increased runoff volume, increased peak discharge, reduced time of concentration, or reduced natural storage.

Design Criteria

Structural Design

Underground tanks shall be designed to prevent failure due to internal or external pressures including hydrostatic uplift pressure and imposed surface loads such as vehicles operated on or adjacent to the tank. Criteria for structural design are outside the scope of this standard. Structural design criteria must be based on sound and accepted engineering principles.

Design Storms

The peak discharge from the 2-year and 10-year frequency, storms shall be analyzed. No increase in peak discharge from these two storms, caused by construction operations or changes in land use, shall be allowed unless the increase in peak discharge does not result in increased potential for erosion.

Some of the items to be considered in determining if there is an increased potential for downstream erosion are:

1. the timing of peak flows from subwatersheds;
2. the increased duration of large flows;
3. the stability of the downstream areas;
4. the distance downstream that the peak discharges are increased.

If there is an overall flood plain management system that considers erosion, downstream peak flow increases that are compatible with the overall flood plain management system may be allowed.

STANDARD
FOR
ROOFTOP STORAGE

Definition

The temporary storage of runoff on a roof, normally a flat roof.

Purpose

Rooftop storage is used to reduce erosion and downstream flooding by temporary storage of runoff.

Conditions Where Practice Applies

This practice applies if there is increased downstream erosion due to construction at development sites or from other land use changes. The increased downstream erosion may be caused by such factors as increased runoff volume, increased peak discharge, reduced time of concentration, or reduced natural storage.

Design Criteria

Structural Design

The roof shall be structurally sound and capable of holding detained storm water as well as wind and snow loads. Requirements for structural stability are outside the scope of this standard and shall be determined by the building designer.

Design Storms

The peak discharge from the 2-year and 10-year frequency, storms shall be analyzed. No increase in peak discharge from these two storms, caused by construction operations or changes in land use, shall be allowed unless the increase in peak discharge does not result in increased potential for erosion.

Some of the items to be considered in determining if there is an increased potential for downstream erosion are:

1. the timing of peak flows from subwatersheds;
2. the increased duration of large flows;
3. the stability of the downstream areas;
4. the distance downstream that the peak discharges are increased.

If there is an overall flood plain management system that considers erosion, downstream peak flow increases that are compatible with the overall flood plain management system may be allowed.

Detention Ring Design

An adequate number of roof drains shall be provided. Emergency overflow measures shall be provided to prevent overloading if roof drains or detention rings become plugged. Detention rings, or other flow restrictors, shall be placed around all roof drains on roofs to be used for storage. The required number of holes or the size of openings in the rings shall be computed on the basis of the area of roof drainage per detention ring and the design storm criteria. Maximum time of storage on the roof shall not exceed 24 hours.

Ownership

To be effective over a long period of time, rooftop storage must be properly maintained. There should be a legally binding and easily enforceable document requiring the building owner to operate and maintain the rooftop storage so that the benefits to the public of installing rooftop storage are received over the life of the practice.

Operation and Maintenance

A plan of operation and maintenance shall be prepared for use by the owner or others responsible for the rooftop storage to insure that it functions properly. This plan shall provide requirements for inspection, operation, and maintenance of the rooftop storage, including outlets. It shall be prepared during design and shall specify who is responsible for maintenance. Adequate access must be provided for maintenance.

STANDARD
FOR
PARKING LOT STORAGE

Definition

The temporary storage of runoff on a parking lot.

Purpose

Parking lot storage is used to reduce erosion and downstream flooding by temporary storage of runoff.

Conditions Where Practice Applies

This practice applies if there is increased downstream erosion due to construction at development sites, or from other land use changes. The increased downstream erosion may be caused by such factors as increased runoff volume, increased peak discharge, reduced time of concentration, or reduced natural storage.

Design Criteria

General

Parking lot storage areas can be used to control runoff from paved areas. Most parking lot storage areas include small ponding areas that have an increased curb height, an outlet control structure, and an emergency overflow. This practice generally is used to control runoff from areas less than 3 acres in size. The parking lot design and installation grades must insure positive flow to the storage area. The storage area must be nearly level, but the slope must be steep enough to facilitate drainage. Positive drainage must be provided to prevent frost damage. Trash guards must be provided to prevent clogging of the outlet control structure. Generally, ponding on the parking lot must not exceed 6 inches in areas where cars and light trucks are to be parked, or 10 inches where heavy trucks are to be parked. Emergency overflow outlets must be provided. Such auxiliary practices as porous pavement and vegetative strips may be used in or adjacent to parking lots to permit infiltration.

Design Storms

The peak discharge from the 2-year and 10-year frequency storms shall be analyzed. No increase in peak discharge from these two storms, caused by construction operations or changes in land use, shall be allowed unless the increase in peak discharge does not result in increased potential for erosion.

Some of the items to be considered in determining if there is an increased potential for downstream erosion are:

1. the timing of peak flows from subwatersheds;
2. the increased duration of large flows;
3. the stability of the downstream areas;
4. the distance downstream that the peak discharges are increased.

If there is an overall flood plain management system that considers erosion, downstream peak flow increases that are compatible with the overall flood plain management system may be allowed.

Outlet Control Structure Capacity

The minimum pipe size shall be 6 inches. The outlet control structures and the temporary flood storage below the emergency overflow must handle the runoff from the design storms without flow through the emergency overflow. Flood routing shall be done using the approximate methods in the Soil Conservation Service Engineering Field Manual, the Soil Conservation Technical Release 55 (TR55), modified rational method as described in Special Report 43 by the American Public Works Association, Practices in Detention of Urban Stormwater, or other generally accepted methods of flood routing.

Ownership

Ownership and responsibility for operation and maintenance of the parking lot storage, after the site is completed, must be determined during design. To be effective over a long period of time, parking lot storage must be properly maintained. Parking lot storage should normally be owned by a unit of government that accepts responsibility for the parking lot storage, and can obtain the money necessary for operation and maintenance work.

If the parking lot storage is not owned by a unit of government, there should be a legally binding and easily enforceable document requiring the owner to operate and maintain the parking lot storage so that the benefits to the public of installing the parking lot storage are received over its intended life.

Operation and Maintenance

A plan of operation and maintenance shall be prepared for use by the owner or others responsible for parking lot storage to insure that it functions properly. This plan shall provide requirements for inspection, operation, and maintenance of the parking lot storage, including outlets. It shall be prepared during design and shall specify who is responsible for maintenance. Adequate access must be provided for maintenance.

STANDARD
FOR
UNDERGROUND TANKS

Definition

The temporary storage of runoff in a buried structure.

Purpose

Underground tanks are used to reduce downstream erosion and flooding by temporary storage of runoff.

Conditions Where Practice Applies

This practice applies if there is increased downstream erosion due to construction at development sites or from other land use changes. The increased downstream erosion may be caused by such factors as increased runoff volume, increased peak discharge, reduced time of concentration, or reduced natural storage.

Design Criteria

Structural Design

Underground tanks shall be designed to prevent failure due to internal or external pressures including hydrostatic uplift pressure and imposed surface loads such as vehicles operated on or adjacent to the tank. Criteria for structural design are outside the scope of this standard. Structural design criteria must be based on sound and accepted engineering principles.

Design Storms

The peak discharge from the 2-year and 10-year frequency, storms shall be analyzed. No increase in peak discharge from these two storms, caused by construction operations or changes in land use, shall be allowed unless the increase in peak discharge does not result in increased potential for erosion.

Some of the items to be considered in determining if there is an increased potential for downstream erosion are:

1. the timing of peak flows from subwatersheds;
2. the increased duration of large flows;
3. the stability of the downstream areas;
4. the distance downstream that the peak discharges are increased.

If there is an overall flood plain management system that considers erosion, downstream peak flow increases that are compatible with the overall flood plain management system may be allowed.

Outlet Capacity

The minimum outlet pipe size shall be 5 inches. The outlet and the temporary storage in the tank must handle the runoff from the design storms. Flood routing may be done using the approximate methods in the Soil Conservation Service Engineering Field Manual, the Soil Conservation Technical Release 55 (TR55), modified rational or other generally accepted methods of flood routing. The maximum time of storage shall not exceed 3 days.

General

In acid or sulfidic soils, tank materials shall be nonreactive with the soil or measures shall be taken to protect the tank from the soil. Provisions shall be made to prevent debris from entering the tank. Debris collectors shall be placed so that the need for maintenance can be readily detected and cleaning operations easily performed. The bottom of the tank shall be on a slight grade to insure complete drainage of the tank. Access must be provided to the tank to permit removal of sediment and other debris.

Ownership

Ownership and responsibility for operation and maintenance of the underground tank, after the site is completed, must be determined during design. To be effective over a long period of time, the underground tank must be properly maintained. Tanks should normally be owned by a unit of government that accepts responsibility for the tank and can obtain the money necessary to do operation and maintenance work. If the underground tank is not owned by a unit of government, there should be a legally binding and easily enforceable document requiring the owner to operate and maintain the tank so that the benefits to the public of installing the tank are received over its intended life.

Operation and Maintenance

A plan of operation and maintenance shall be prepared for use by the owner or others responsible for the underground tank to insure that it functions properly. This plan shall provide requirements for inspection, operation, and maintenance of the tank, including outlets. It shall be prepared during design and shall specify who is responsible for maintenance. Adequate access must be provided for maintenance.

STANDARD
FOR
CUT TO FILL SLOPE TREATMENT

Definition

Treatment of the critical transition area of cut to fill.

Purpose

Treatment to preserve the transition from cut to fill.

Conditions Where Practice Applies

Protection should be designed when there is a ditch on a cut section of roadway that transitions to a fill section before the water is pitched up.

Design Criteria

1. Dumped stones shall be placed a distance of 10' up the cut section and continue down through the transition for a distance of 25'.
2. Hay bales shall be placed along the cut section ditch.
3. A sediment pool shall be required if the ditch outlets into a stream or waterway.

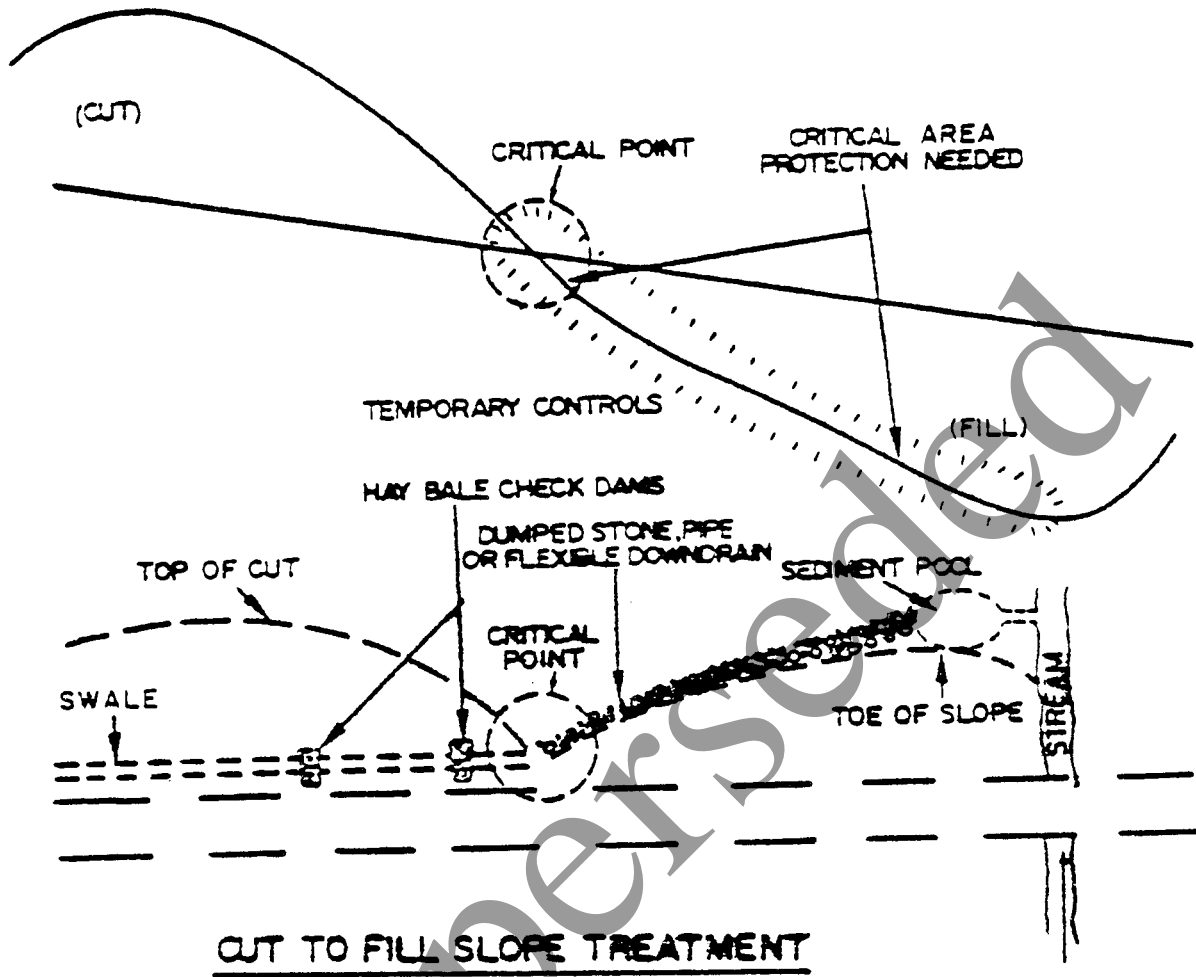

STANDARD
FOR
TEMPORARY DAMS

Definition

A low head barrier of various materials.

Purpose

To reduce water velocities and allow deposits of small sediment loads into swales and ditches.

Conditions Where Practice Applies

Any swale or ditch where the velocity would be such as to create erosion of the channel. Temporary dams are required at the end of swales and ditches immediately before they enter a natural channel or water course.

Design Criteria

1. All types of dams should extend far enough up the side of the swale or ditch to effectively pond the runoff and prevent erosion and washout.
2. Size of openings for all types of dams shall be determined by the Engineer in the field.
3. Staked Bale Dam
 - a. Bales will be staked with two stakes.
 - b. When height of dam is two bales or more, stakes will be long enough to penetrate each bale and also extend 1½' to 2' into the ground.
 - c. Stone will be placed at the base of the dam opening to prevent washout.
4. Hay Bales & Fence
 - a. Fence post shall be spaced 8' center to center or closer.
 - b. Metal fence with 6" or smaller openings shall be fastened to the fence posts.
 - c. Hay bales shall be placed on the upstream side of the fence and staked as described above if deemed necessary by Engineer.

NOTE: DAM SHOULD EXTEND FAR ENOUGH UP DITCH SIDE SLOPES TO EFFECTIVELY POND THE RUNOFF AND PREVENT EROSION AND WASHOUT.

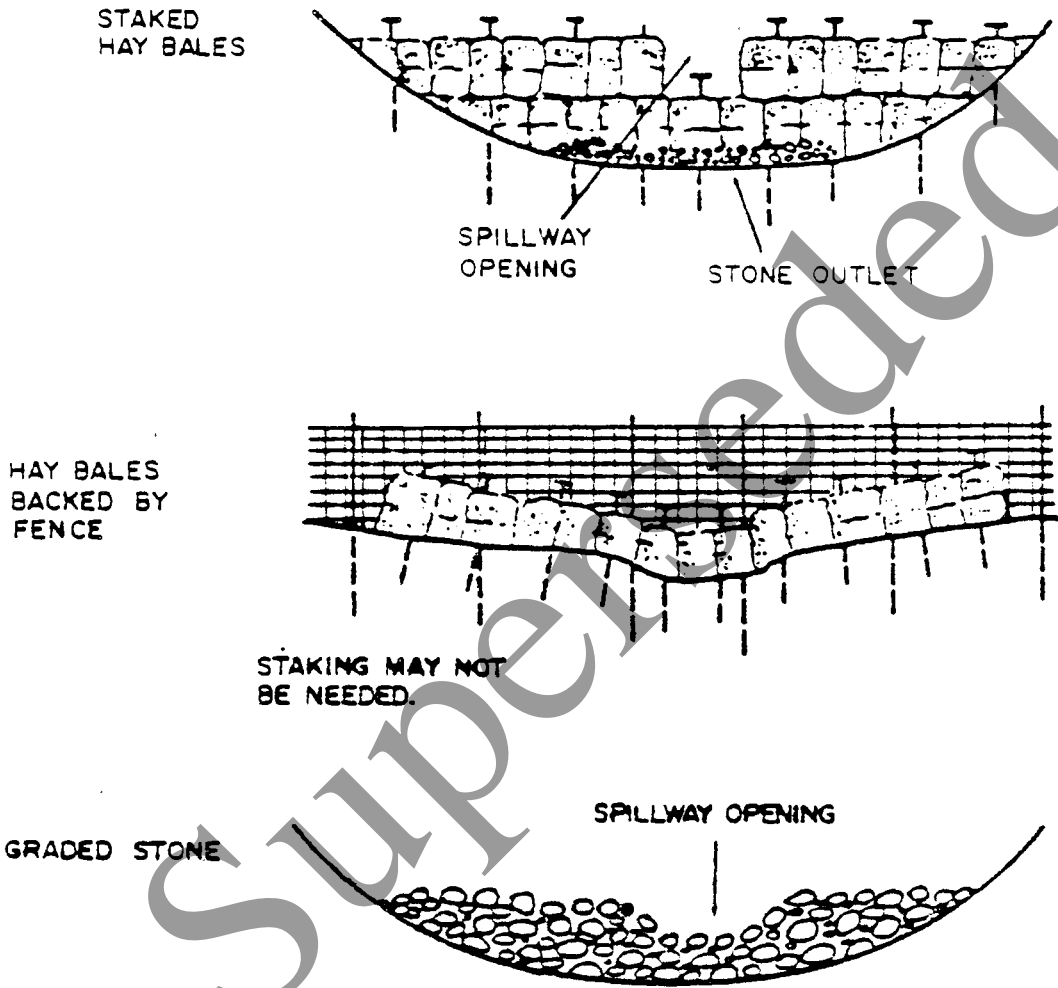

TYPES OF TEMPORARY DAMS

STANDARD
FOR
SEDIMENT BARRIER (HAY BALES)

Definition

Hay bales or straw barrier when existing ground slopes toward highway embankment.

Purpose

To check the movement of eroded soil at the toe of unstabilized slopes

Conditions Where Practice Applies

Where erosion would occur in the form of sheet and rill erosion.

Design Criteria

1. One bale shall be placed on each slope with a 6 to 12" overlap.
2. Each set of bales shall be on 12' centers.
3. Bales shall be embedded 4 to 6".
4. Two stakes (2" x 2" x 3') shall be driven through each bale a depth of 1 ½ to 2' into the ground.

ANCHOR EACH BALE WITH TWO-2"X2"X3'
STAKES DRIVEN 1-1/2' TO 2' INTO THE GROUND.

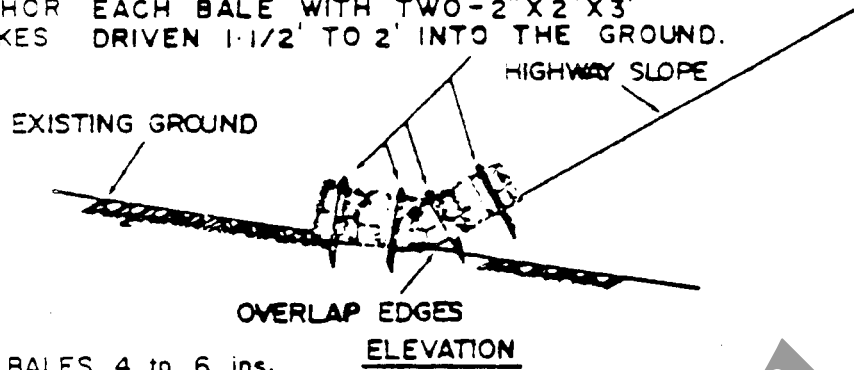

NOTE: EMBED BALES 4 to 6 ins.

See Embedding Detail
Figure 2.13-1

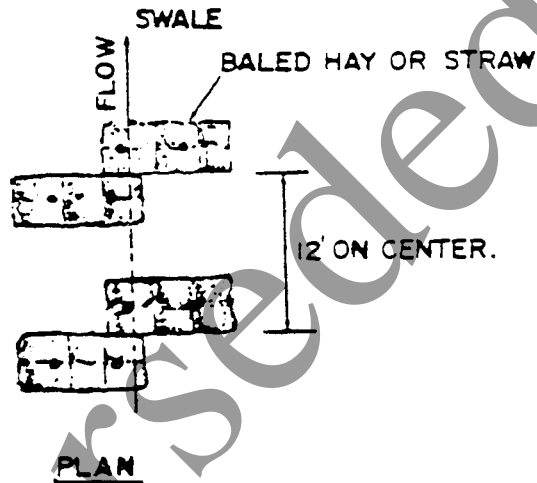

NOTE: TO BE USED WHERE THE EXISTING GROUND SLOPES TOWARDS THE HIGHWAY EMBANKMENT
AS CALLED FOR ON PLANS.

BALED HAY EROSION CHECKS

STANDARD
FOR
INLET PROTECTION - HAY BALE BARRIER

Definition

A temporary barrier and settling facility installed at a storm sewer inlet.

Purpose

The purpose of storm sewer inlet protection is to intercept and retain sediment, thus preventing the entrance of sediment into the system.

Conditions Where Practice Applies

Any inlet that needs protection from sediment with a drainage area of three acres or less.

Design Criteria

1. The barrier shall encircle the inlet.
2. The perimeter length of the barrier shall be at least 4 times the perimeter length of the inlet.
3. The top of the barrier shall be even and uniform.
4. The hay bales shall be held in place with two stakes (2" x 2" x 3') driven 1½ to 2' into the ground.
5. If staking is not practical, the hay bales shall be tied together to prevent movement.

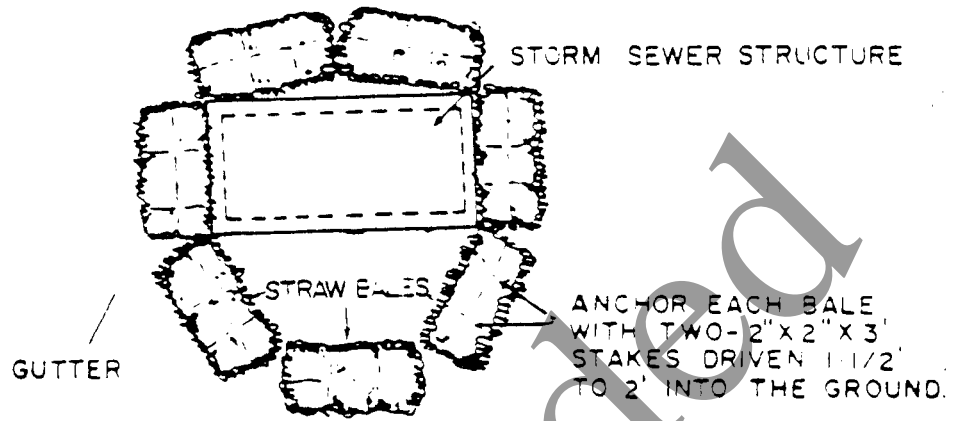

TREATMENT TEMPORARY BARRIER-HAY BALES AROUND
DRAINAGE STRUCTURE

STANDARD
FOR
INLET SEDIMENT TRAP

Definition

A temporary settling facility at a storm sewer inlet.

Purpose

The purpose is to intercept and retain sediment, thus preventing the entrance of sediment into the storm sewer system.

Conditions Where Practice Applies

1. Contributory drainage area is 3 acres or less.
2. At an inlet that will remain incomplete for an extended period of time.
3. At a location where there is overland flow onto the roadway.

Design Criteria

1. A screen is placed completely over the inlet.
2. A sediment trap is excavated behind the curb at the inlet. The trap shall be at least 24" deep and 36" wide (measured from the curb line), and 7'-10" long.
3. There will be 12" curb cuts in the berm or curb on either side of the inlet. These cuts will be repaired when the trap is removed.
4. Stone filter will be quarry process stone.

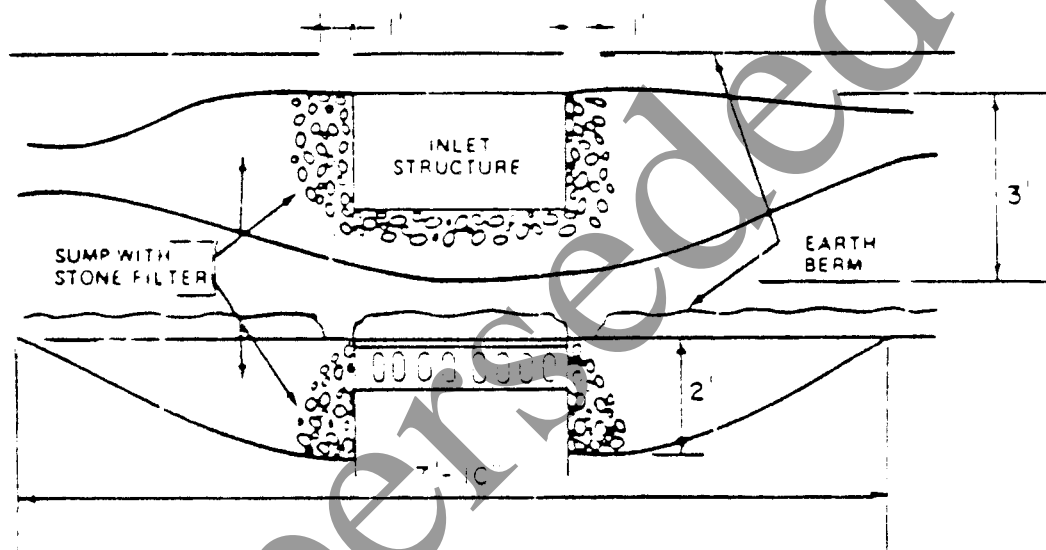

INLET SEDIMENT TRAPS

STANDARD
FOR
STORM SEWER INLET PROTECTION
(Temporary Sump-Stone Filter)

Definition

A temporary settling facility at a storm sewer inlet.

Purpose

The purpose is to intercept and retain sediment, thus preventing the entrance of sediment into storm sewer system.

Conditions Where Practice Applies

1. Contributing drainage area is 3 acres or less.
2. At an inlet that will remain incomplete for an extended period of time.

Design Criteria

1. Stone filter will be quarry process stone.
2. Sump will be 3' wide around inlet.
3. An 8" diameter pipe will drain sump on two sides.
4. Sump will be a minimum of 2' deep.

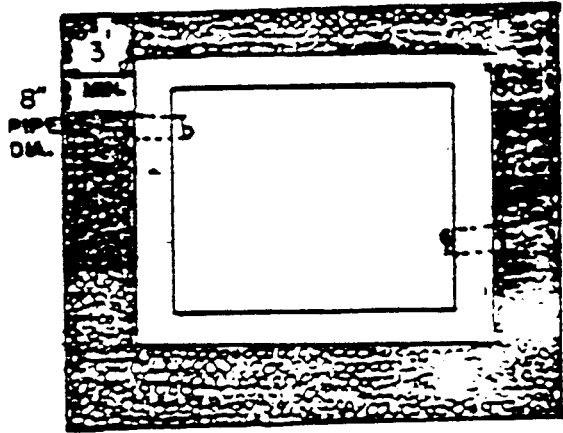

INCOMPLETE INLET OR
CATCH BASIN STRUCTURE

8" PIPE DIA.

SUMP WITH STONE FILTER
SHALL BE QUARRY PROCESSED STONE

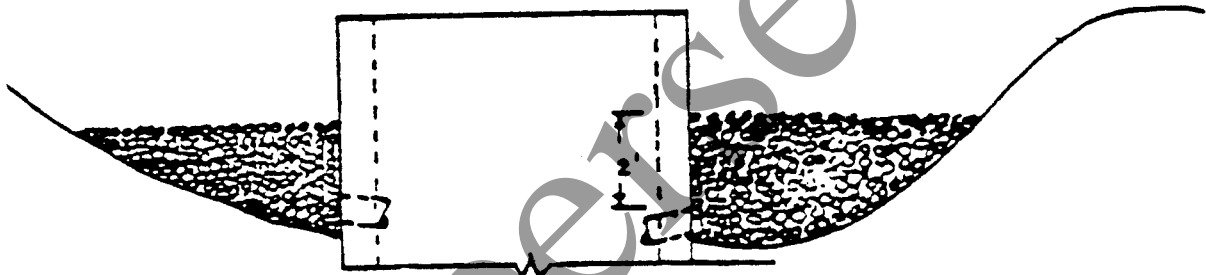

TEMPORARY SUMP-STONE FILTER
AROUND DRAINAGE STRUCTURE

STANDARD
FOR
FLOATING TURBIDITY BARRIER

Definition

A temporary floating barrier at streams or waterways within the construction site.

Purpose

To prevent the siltation of streams or waterways that pass through or about the construction site.

Conditions Where Practice Applies

Floating turbidity barrier shall be used whenever construction operations are directly located in a stream or water course, or where a drainage pipe that may carry silt is outletted into a stream or waterway.

Design Criteria

1. Barrier will be on a 50' radius from the shore line at point discharge.
2. Barrier will extend across the entire channel.
3. Barrier material will be a Polyethylene Plastic sheet, 10 mil., or suitable alternate to fit existing conditions.
4. Weights will be at 10' intervals along the entire length. They shall be 5 pounds and extend 12" below the bottom of the material.
5. Floats will be at 5' intervals; there will be two floats at each location, one on either side of the material.
6. Rope will be 1/4" nylon or manila.

FLOATING TURBIDITY BARRIER

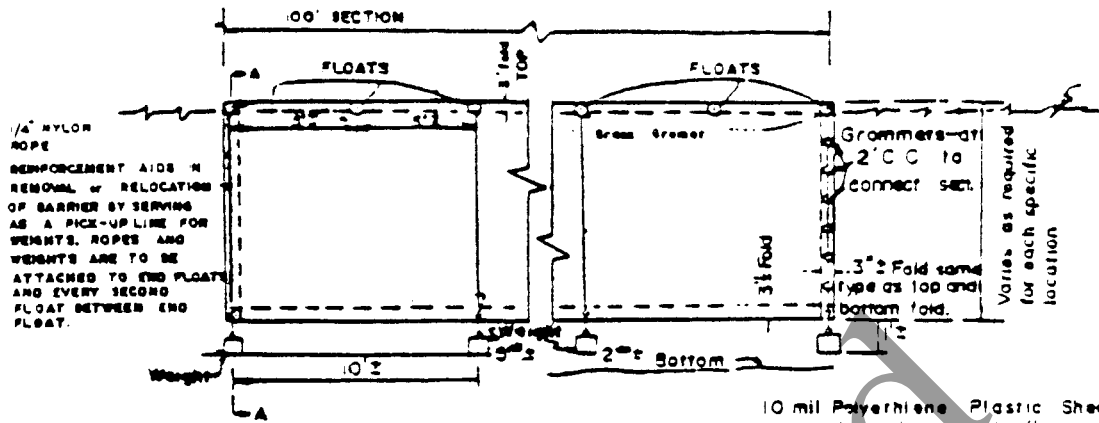

FRONT VIEW

10 mil Polyethylene Plastic Sheet or suitable alternate to fit existing conditions as approved by the Engineer.

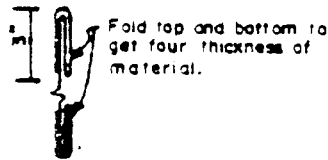

SIDE VIEW

FOLDING DETAIL

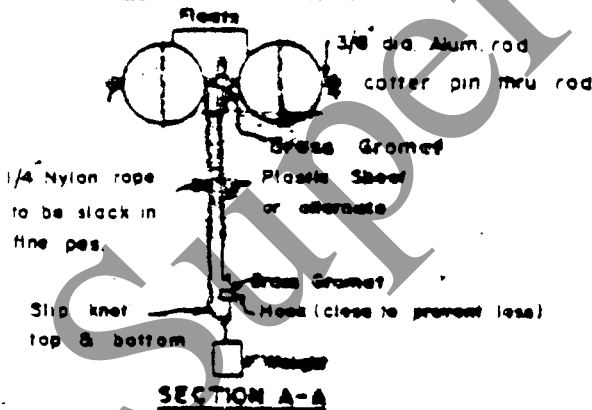

NOTE: At shallow water locations the plastic sheet or suitable alternate may be fastened to stakes driven into the bottom in lieu of floats and weights.

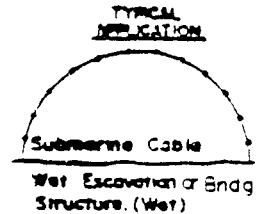
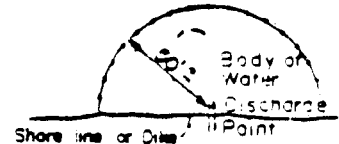
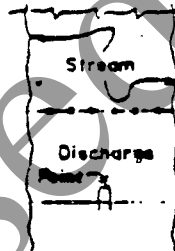

GENERAL NOTES:

Silt Barrier to prevent drifting of silt cause by discharge of storm sewers during construction, dredging or filling operations.

Exact placement of silt barrier shall be so as to effectively control silt dispersion under the conditions present on a particular project.

The details shown on this sheet are suggested methods, only alternate solutions and usage of materials may be used as approved by the Engineer.

STANDARD
FOR
STAKED TURBIDITY BARRIER

Definition

A temporary staked silt barrier at existing ditch locations.

Purpose

The purpose is to intercept and detain sediment from infiltrating existing ditches that drain the construction site.

Conditions Where Practice Applies

A staked barrier should be placed where the drainage from the site is tributary to an existing ditch that outlets off the site. Distance between barriers shall not exceed 500'.

Design Criteria

1. Frames will be constructed with 2" x 6" boards.
2. Pilings will be a minimum 6" in diameter at the butt end.
3. The depth of the pilings will be at the discretion of the engineer.
4. Attached to the frame will be 20 gauge poultry netting with 1" Net.
5. The silt retainer will be plastic filter blanket extending from the top 2" x 6" boards to 4' beyond the bottom 2" x 6" board.
6. The blanket and poultry netting should extend to the ditch bottom with proper anchoring to prevent silt from escaping under the barrier.

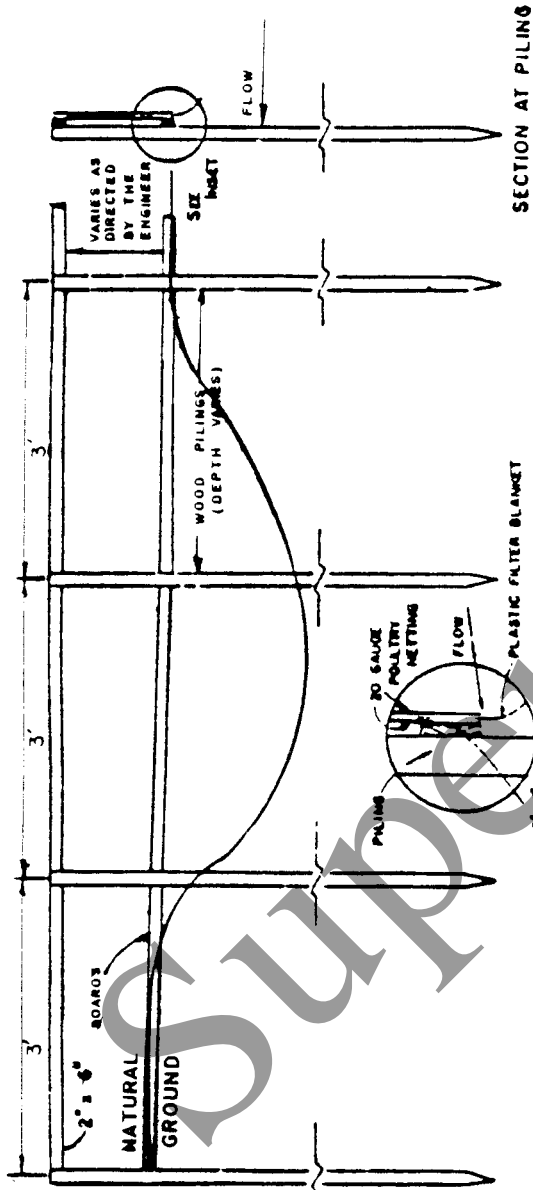

NOTES: THE FRAME WILL BE CONSTRUCTED WITH 2" X 6" BOARDS. PILING WILL BE A MINIMUM OF 6" IN DIAMETER AT THE BUTT END. THE DEPTH OF PILING WILL BE AT THE DISCRETION OF THE PROJECT ENGINEER. ATTACHED TO THE FRAME WILL BE 20 GAUGE POULTRY NETTING WITH 1" NET. THE SILT RETAINER WILL BE PLASTIC FILTER BLANKET EXTENDING FROM THE TOP 2" X 6" BOARD TO 4' BEYOND THE BOTTOM 2" X 6" BOARD. IN THE DITCH BOTTOM THE BLANKET AND POULTRY NETTING SHOULD EXTEND TO THE DITCH BOTTOM AND BE ANCHORED IN PLACE BY MEANS AVAILABLE TO THE CONTRACTOR TO EFFECTIVELY PREVENT SILT FROM ESCAPING FROM UNDER THE BOTTOM OF THE BARRIER. (SEE DETAIL BELOW)

STAKED TURBIDITY BARRIER

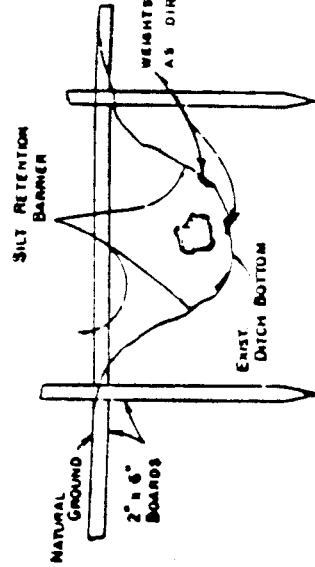

PLACEMENT OF STAKED SILT BARRIER AT EXISTING DITCH LOCATIONS

Appendix A1

THE UNIVERSAL SOIL LOSS EQUATION *

Determining Sediment Yield from Construction Sites and Development

Introduction

Sediment, a common term for eroded soil, is the most massive pollutant of surface water. Our growing population and high standards of living require construction of more houses, shopping centers, highways, waterways, and other facilities that involve clearing of vegetation and massive movement of soil. These activities expose the soil directly to the erosive actions of rain and flowing water. As a result, an enormous amount of soil is lost from these sites causing high turbidity to the water that carries it and damaging the site where it is finally deposited.

The Universal Soil Loss Equation, commonly known as the USLE, is a valuable technique for estimating erosion rates and evaluating various conservation practices for controlling erosion and sedimentation (deposition).

The Soil Erosion - Sedimentation Process

Since soil erosion and sedimentation by water are complex processes, a better understanding of them provides a sound basis for developing improved predictions and control methods. Soil erosion and sedimentation by water include detachment from the soil mass, transport downslope, and subsequent deposition. Soil is detached by raindrop impact and runoff shear forces, but man's activities that loosen and pulverize soil often promote accelerated erosion. Downslope transportation of eroding soil particles is primarily by channelized runoff. Generally, three distinct forms of erosion are seen in the upland areas. These are sheet erosion, rill erosion and gully erosion. Sheet erosion, also known as interrill erosion, takes place uniformly between rills or gullies. Sheet erosion results primarily from raindrop impact. The erosive potential of rain depends on its raindrop size, fall velocity and total mass at impact. Unless the soil surface is protected against raindrop impact by vegetation, mulches, or other cover, these raindrops can detach great quantities of soil and cause serious unnoticed interrill erosion.

*Page A1-1-A1-20 written by Dr Devah Borah and presented at Cook College, Rutgers University, Sediment and Erosion Control Short Course, Spring 1986.

Rill erosion is much more noticeable than interrill erosion. It is primarily the result of soil detachment by concentrated runoff, it causes intensive soil movement from a limited part of the land surface. Rills, which are small channels that can be easily smoothed, may first develop due to topographic variations, tillage marks, or random irregularities on the land surface. Rills carry both runoff from interrill areas and the rain that falls directly on them. Rill erosion increases rapidly as the slope steepens or lengthens and runoff rate increases.

Gully erosion is massive removal of soil by large concentrations of runoff. Gullies often start as rills and enlarge until they cannot be crossed by vehicles such as trucks and tractors. If permitted to form, gullies may yield tremendous volumes of sediment.

The quantity and size of material transported is a function of runoff velocity and turbulence, and these increase as the slope steepens and the flow increases. The larger the eroding material, the greater must be the flow velocity and turbulence to transport it. When the velocity or turbulence decreases, some of the eroded sediment may deposit. The largest and densest particles settle first while the finer particles are carried farther downslope or downstream.

Estimating Sediment Yield

The rate of sheet erosion depends on several factors as follows: (1) rainfall energy and intensity, (2) soil erodibility, and (3) land slope and length of slope or topography, (4) condition of the soil surface and land management practices in use and (5) surface cover involved such as grass, woodland, crops, pavement or no cover at all. These factors may be assigned quantitative values to be used for computing soil loss by the Universal Soil Loss Equation, $E = RK (LS) CP$, where E is the estimated soil loss from sheet erosion in tons per acre per year. See ref. (3).

R , the rainfall factor, is the number of erosion index in a normal year's rain. The erosion index is a measure of the erosive force of specific rainfall. See figure A1-1 for values of R .

K , the soil-erodibility factor, is the erosion rate per unit of erosion index for a specific soil in cultivated continuous fallow on a 9 percent slope 72.6 feet long. See Table A1-2a, A1-2b or A1-2c for values of K and (KR) , the product of K and R , for New Jersey soils.

L, the slope length factor, is the ratio of soil loss from the field gradient to that from a 9 percent slope. See Table A1-3 for values of (LS) for various slope gradient and length combinations.

C, the cropping management factor, is the ratio of soil loss from a field with specified cropping management to that from the fallow condition on which the factor K is evaluated. This factor is also called the cover index and can be used to represent the effect of land cover or treatment that may be used to protect the construction site. See table A1-4 for values of the soil cover index Cc for treatment that may be used to protect construction sites.

P, the erosion control practice factor, is the ratio of soil loss with the contour stripcropping or terracing to that with straight row farming up and down the slopes. The condition of the soil surface, particularly at construction sites, can also be reflected in the practice factor. See table A1-5 for soil surface condition factors Pc for construction sites.

The value E may also be modified by a factor M shown on table A1-6. M may be used to estimate the soil loss for a portion of a year and a portion of another year or more. The use of this factor provides a means of estimating the average soil loss on a critical sediment source area that will remain as such for a portion of a year or during the performance time of a construction contract.

The factor R is equal to the average annual value of the erosion index EI when the equation is being used to estimate average annual soil loss. This value of the equation may be modified to reflect soil loss probability and individual storm losses. Estimates of average soil loss, based on probability and single storm losses, can be made by multiplying the equation by the factors shown in table A1-8. These factors reflect an alteration in the value of R and, therefore, the erosive effect of rainfall. They do not account for such things as snow melt, freezing, thawing and snow cover.

Detailed definitions and explanations for each of these factors are contained in Reference (3).

The soil information contained in Tables A1-2a, A1-2b and A1-2c are of general nature, useful for planning purposes. It should be used, without verification, for evaluation of construction sites for erosion control. Where

erosion may be expected during construction involving earth moving, on-site investigations should include information on soils to be exposed as follows: (1) field identification and classification for both agriculture textures and the unified system, (2) sampling for grain size distribution, Atterburg limits and laboratory classification, and (3) in-place density as determined by a volumeter and the speedy moisture tester or other means.

The soil grain size is useful in determining the value of practices for the control of erosion and particularly sediment. For example, sediment basins will not be very effective for trapping very fine sediment. Soils made up of a high percentage of material with the grain size of 0.05 mm or less have a slow settling velocity in water. Material with a 0.05 mm grain size has a settling velocity close to 0.006 feet per second. This means that, theoretically, a detention time of about 15 minutes is required to settle out 0.05 mm material in 5 feet of still water.

Soil loss computed by the universal loss equation represents gross sheet erosion. This value plus erosion from the rilling, gullies and other sources is the gross erosion. To obtain sediment yield at the point downstream, the gross erosion must be adjusted downward by a delivery rate factor in percent equal to the ratio of sediment yield at the damage area to gross erosion. Delivery rates vary somewhere between 10 percent and 90 percent depending on conditions that tend to trap sediment between the source and the damage area.

Water pollution in the form of turbidity or discoloration may be as damaging to water supplies or swimming areas as the accumulation of sediment. Turbid water may be the result of algae or other organisms but generally it is caused by the fine silt or clay particles held in suspension. The very fine, divided clay particles found in some soils are difficult to control and may take months to settle out in still water.

Downstream damage from sediment depends on the following conditions:

1. Distance from the construction site to the nearest stream, pond or reservoir along with the condition of the vegetation and the slope of the area between the site and the stream of the reservoir. Areas with flat slopes and dense vegetation will tend to filter out sediment.

2. Once the sediment gets into a stream, the distance downstream to the damage point, such as a pond or water supply intake, is important. Also to be considered is the stream channel gradient and the flood plain width. Wide flat flood plains with dense vegetation will trap more sediment than steep narrow valleys.
3. The use of the stream or reservoir must be considered. It is very important to keep sediment out of streams used for fishing, recreation or water supply.
4. Another factor that should be considered is the size of the construction area and the length of time it will be bare of vegetative cover and subject to erosion. The total sediment expected should be compared with the capacity of the damage area to sustain sediment. If the total sediment to be expected from the site during the entire construction period is greater than can be tolerated in the damage area, considerable effort should be made to reduce it. If this cannot be done, arrangements to alleviate the damage should be made. These arrangements may include cleanout of ponds and reservoirs or restoration of stream channels.

A look at the Soil Loss Equation will show the factors over which man can exercise some control. These are lengths of slope, exposure time, and the total area exposed. Slope length is contained in the equation as part of the (LS) factor and its effect on soil loss can be evaluated. The length of time and time of year of soil loss from different size areas, can also be estimated.

"LS" Factor for Composite Slopes

LS values given in table A1-3 predict the average soil loss for the entire length of a slope. Such a slope length is measured from the point where surface flow originates (usually the top of the ridge) to the outlet channel or a point down slope where deposition begins. When a slope steepens or flattens significantly toward the lower end, or is composed of a series of convex and concave segments, its overall average gradient and length do not correctly indicate the topographic effect on soil loss. Neither can successive slope segments be evaluated as independent slopes when runoff flows from one segment to the next. For irregular slopes values read from the aforementioned table must be adjusted to account for effects of the gradient changes.

The irregular slope is divided into a small number of equal-length segments in such a manner that, for practical purposes, the gradient within each segment can be considered uniform. The LS values corresponding to the steepness of each of the slope segments are read from table A1-3. While reading these values, the entire length of the irregular slope is taken. These LS values are multiplied by the corresponding factors given in the following table (Wischmeier, 1974). Each individual product is an estimate of LS value for the corresponding slope segment and the average of the products is an estimate of the effective LS value for the entire irregular slope. The procedure is valid only for situations where upslope deposition is not possible.

FACTORS TO ADJUST "LS" VALUES FOR COMPOSITE SLOPES

Segment No. (Top to Bottom)	Adjustment Factors for Given Number of Equal-length Segments			
	2	3	4	5
1	0.71	0.58	0.50	0.45
2	1.29	1.06	0.91	0.82
3		1.37	1.18	1.06
4			1.40	1.25
5				1.42

"C" Values for Various Mulches

Table A1-4 gives C values and slope-length limits for various nonseed and seeded mulches used in controlling soil erosion. This table is taken from Meyer and Ports (1976). By using these values in the USLE, the effectiveness of various mulches can be determined in controlling soil erosion.

Sediment Delivery Ratio

Since the USLE predicts only the soil loss by rill and interrill erosion from the field-size areas, sediment yields from larger areas of watersheds must be estimated by adding

additional erosion from gullies and streambanks along the flow path and subtracting eroded soil that is deposited at the base of a slope and elsewhere within the watershed. If additional gully or channel-type erosion is significant, it should be estimated and added to the predicted upland erosion to give the gross erosion occurring in the watershed above the location of interest. Deposition of eroded soil is accounted by simply using a sediment delivery ratio which is defined as the ratio of the sediment leaving the watershed to the estimated gross erosion on the watershed. Delivery ratios are generally much less than 1, because most natural slopes tend to flatten along their lower portions, which encourages deposition, and heavy vegetation often traps sediment below the upland slopes. However, urban erosion sources often lack locations where deposition is likely to occur and, in such cases, the delivery ratio will approach 1. Figure 2-4-2 gives delivery ratios for different soil texture and drainage areas. A general guide to sediment delivery ratios from construction sites is given as follows:

Guide To Delivery Ratio For Sediment From Construction Sites

Damage Area Condition (Reservoir, stream reach or other area that could be damaged by sediment)	Estimated Delivery Rates \1
Less than 300 feet from the down slope boundary of the construction site.	.90
More than 300 feet down slope from the construction site but not downstream any appreciable distance.	.70
Less than 1 mile downstream from the construction site (stream flows through or less than 300 feet from the slope boundary of site)	.60
Damage area more than 1 mile downstream	.50 or less

\1 New Jersey State Soil Conservation, "Sediment Pollution and Erosion Control Guide for Resource Conservation", Technical Guide, 1971. The values are based on judgement only. They should be considered as a general guide.

The Universal Soil Loss Equation has been widely adapted for use in estimating erosion rates and selecting sediment control practices for urban areas. It is a valuable design tool when properly applied, but its misuse can cause serious problems.

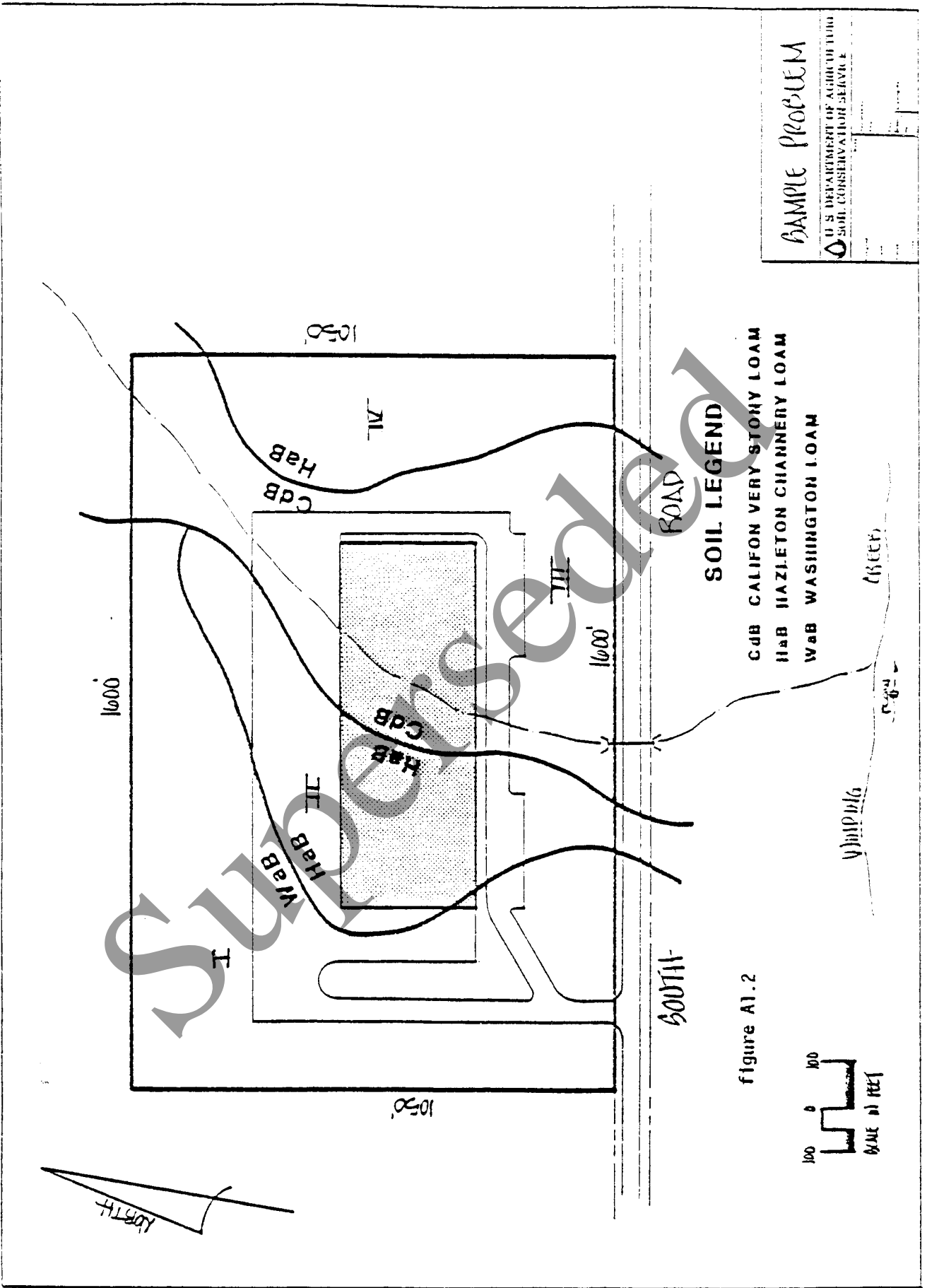

SAMPLE PROBLEM

U.S. DEPARTMENT OF AGRICULTURE
SOIL CONSERVATION SERVICE

SOIL LEGEND

- CdB CALIFON VERY STONY LOAM
- Hab HAZLETON CHANNERY LOAM
- WAB WASHINGTON LOAM

figure A1.2

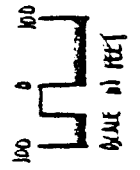

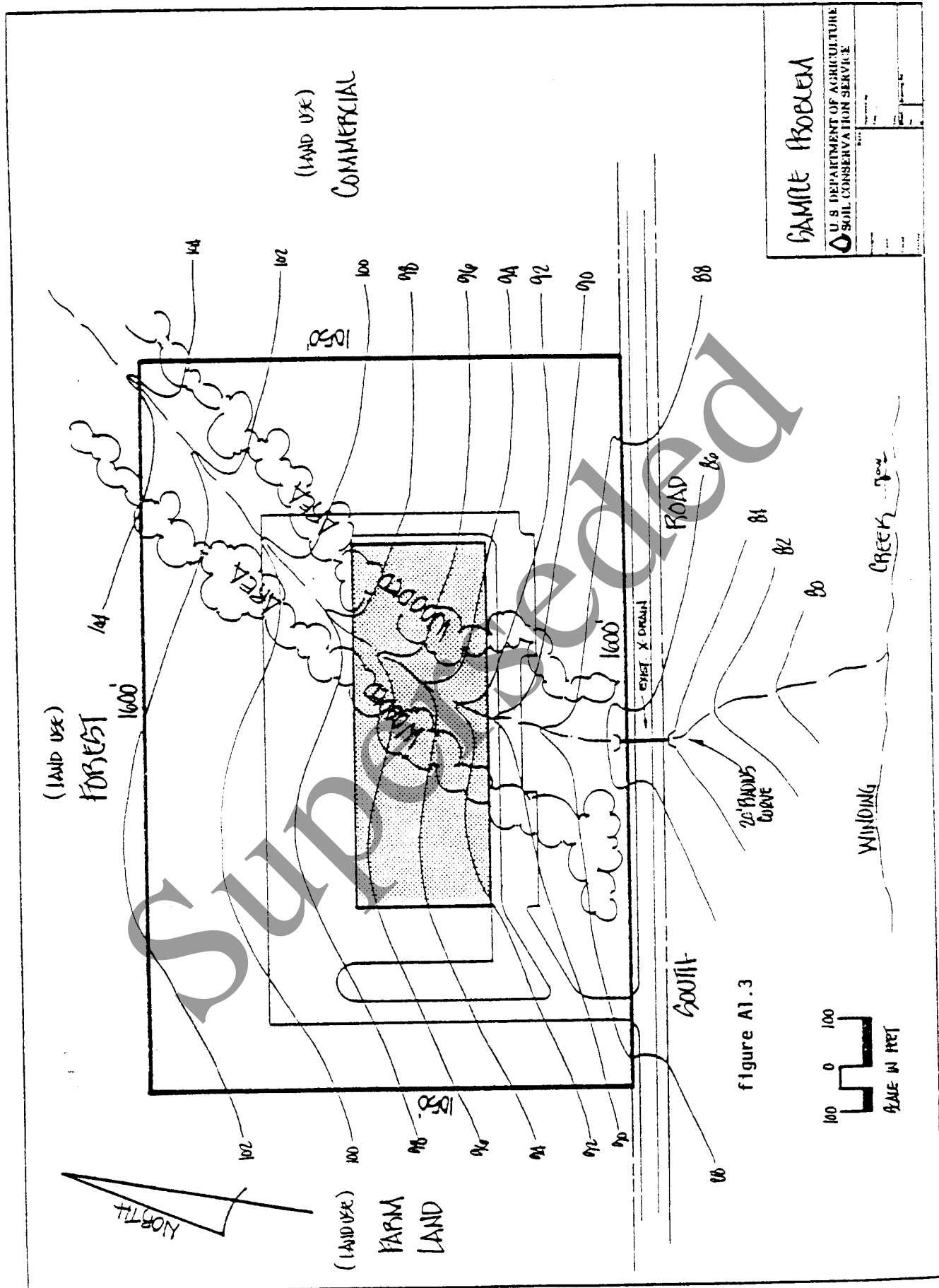

SAMPLE PROBLEM
 U. S. DEPARTMENT OF AGRICULTURE
 SOIL CONSERVATION SERVICE

Sample Problem

Consider the following sample construction site. The site is located in the land resource area 148 of New Jersey. The land will be prepared for construction and will be exposed during an eighteen-month construction period starting from April 1 and ending on September 30 of next year. Assume that the upper edge of the site is a ridge so that there will be no overland flow contributing from the outside areas.

1. Required: For this site find the weighted soil erodibility factor.

Solution: Estimate the soil erodibility factor "K" as follows

Sub Area	Soil Series	Soil *1 Profile (inches)	Area "a" (ac)	K (t/ac)	Area in subarea "A" (ac)	Weighted K in subarea $\sum \frac{ak}{A}$ (t/ac)	AK tons
I	WaB	0-9	10.4	0.28	14.5	0.29	4.2
		9-52	4.1	0.32			
II	HaB	0-6	1.7	0.17	6.8	0.16	1.1
		6-56	5.1	0.15			
III	CdB	0-10	6.9	0.17	12.6	0.23	2.9
		10-50	5.7	0.30 *2			
IV	HaB	0-6	4.7	0.17	4.7	0.17	0.8
Total					38.6		9.0

Weighted K = $\frac{\sum AK}{\sum A} = 9/38.6 = 0.23 \text{ t/ac (answer)}$

Note:

The soil interpretation record of each soil series is used. In absence of these records, Table A1-2 can be used. Since the construction site has several soil series with different surface areas (Figure A1-2) and different K values, the composite K value must be weighted. Also, the soil profile which will be exposed for construction will be different at different locations (Figure A1-3). These differences must also be accounted for by further weighing. *1 Assumed that the building and parking area is leveled around 95-ft contour. *2 $(0.32 + 0.28)/2 = 0.30$

HLRA(S): 144A, 14B
REV. HLA-CKX, 5-81
TYPIC FRAGIBULIS, FINE-LOAMY, MIXED, MESC

THE CALIFON SERIES CONSISTS OF DEEP, MODERATELY WELL AND SOMEWHAT POORLY DRAINED SOILS ON UPLANDS. THEY FORMED IN GLACIAL TILL OR COLLUVIAL MATERIAL. TYPICALLY THESE SOILS HAVE A DARK BROWN VERY STONY LOAM SURFACE LAYER 10 INCHES THICK. THE SUBSOIL LAYERS FROM 10 TO 23 INCHES ARE STRONG BROWN LOAM AND CLAY LOAM. A VERY FIRM AND BRITTLE MOTTLED FRAGIPAN FROM 23 TO 50 INCHES IS MAINLY STRONG BROWN AND YELLOWISH-BROWN LOAM. THE SUBSTRATUM FROM 50 TO 75 INCHES IS YELLOWISH-BROWN SANDY LOAM. SLOPES RANGE FROM 9 TO 15 PERCENT.

DEPTH (IN.)	USDA TEXTURE	UNIFIED	AASHTO	PERCENT OF NATURAL CLSS				LIMIT	PLAS- TICITY INDEX
				>3 IN. (PCT)	3-10 (PCT)	10-60 (PCT)	60-100 (PCT)		
0-10	SL, CL, GR-L	ML, SM-SC, CL, CL-ML	A-4, A-5	3-10 80-100	60-95	35-80	30-70	20-30	1-10
10-23	SL, CL, GR-L	ML, SM-SC, CL, CL-ML	A-4, A-5	3-10 85-100	60-95	35-90	45-70	23-40	3-15
23-50	SL, CL, GR-SL	SM, ML, CL, SC	A-4, A-6, A-7	3-10 85-100	65-95	40-90	25-70	23-40	3-15
50-60	SL, CL, GR-LS	SM, ML, CL, SC	A-2, A-4, A-1, A-6	3-10 75-95	65-95	35-90	15-75	15-40	3-15

DEPTH (IN.)	MOISTURE DENSITY (PCT)	WATER CAPACITY (M/IN)	SOIL REACTION (PH)	SATIN- SWELL POTENTIAL	PERCENT ORGANIC MATTER (PCT)	CONDUCTIVITY (UMH/CM)
0-10	0.8-2.0	0.18-0.20	4.5-5.5	LOW	0.12	100
10-23	0.8-2.0	0.10-0.20	4.5-5.5	LOW	0.12	100
23-50	0.06-0.2	0.06-0.10	4.5-5.5	LOW	0.28	100
50-60	0.8-2.0	0.14-0.18	4.5-5.5	LOW	0.28	100

FLOODING	HIGH WATER TABLE	CEMENTED PAV	BRICK	CONCRETE	TRIPOTENT

SANITARY FACILITIES (B)		CONSTRUCTION MATERIAL (B)	
SEPTIC TANK ABSORPTION FIELDS	SEVERE-WETNESS, PERCS SLOPE	ROADFILL	POOR-FROST ACTION
SEWAGE LAGOON AREAS	0-3%: SLIGHT 2-7%: MODERATE-SLOPE 7+%: SEVERE-SLOPE	SAND	IMPROVABLE-EXCESS FINES
SANITARY LANDFILL (TRENCH)	SEVERE-WETNESS	GRAVEL	IMPROVABLE-EXCESS FINES
SANITARY LANDFILL (AREA)	SEVERE-WETNESS	TOPSOIL	POOR-LARGE STONES
DAILY COVER FOR LANDFILL	0-8%: FAIR-LARGE STONES, SMALL STONES 8-15%: FAIR-SLOPE, LARGE STONES, SMALL STONES	POND RESERVOIR AREA	WATER MANAGEMENT (2) 0-3%: MODERATE-SLOPE 3-8%: MODERATE-SLOPE 8+%: SEVERE-SLOPE
BUILDING SITE DEVELOPMENT (B)		SEVERE-PIPING, WETNESS	
SHALLOW EXCAVATIONS	SEVERE-WETNESS	EMBANKMENTS DIKES AND LEVEES	SEVERE-NO GATE
DWELLINGS WITHOUT BASEMENTS	SEVERE-WETNESS, FROST ACTION	EXCAVATED PONDS AQUIFER FED	SEVERE-NO GATE
DWELLINGS WITH BASEMENTS	SEVERE-WETNESS	DRAINAGE	LARGE STONES, PERCS SLOPE, WETNESS
SMALL COMMERCIAL BUILDINGS	0-3%: SEVERE-WETNESS, FROST ACTION 8-15%: SEVERE-SLOPE, WETNESS, FROST ACTION	IRRIGATION	LARGE STONES, PERCS SLOPE, WETNESS
LOCAL ROADS AND STREETS	SEVERE-FROST ACTION	TERRACES AND DIVERSIONS	LARGE STONES, PERCS SLOPE, ROOTING DEPTH
LAWNS, LANDSCAPING AND GOLF FAIRWAYS	0-8%: MODERATE-LARGE STONES, SMALL STONES, WETNESS 8-15%: MODERATE-SLOPE, LARGE STONES, WETNESS	GRASSED WATERWAYS	LARGE STONES, PERCS SLOPE, ROOTING DEPTH
REGIONAL INTERPRETATIONS			

RECREATIONAL DEVELOPMENT (C)

CAMP AREAS	0-82: MODERATE-SLOPE, WETNESS, LARGE STONES 0-152: MODERATE-SLOPE, WETNESS, LARGE STONES	PLAYGROUNDS	0-82: SEVERE-SMALL STONES, WETNESS 0-152: SEVERE-SLOPE, SMALL STONES, WETNESS
PICNIC AREAS	0-82: MODERATE-SLOPE, WETNESS 0-152: MODERATE-SLOPE, WETNESS	PATHS AND TRAILS	MODERATE-SLOPE, WETNESS, LARGE STONES

EXPANSION AND TOOLS BY ACTS OF CONGRESS AND PASTURE HIGH WOOD MANAGEMENT

CLASS- DETERMINING PHASE	CAPABILITY	7ASTURE (AUM)	1	2	3	4	5	6	7	8	9	10
0-82	55	5.0										
0-152	65	6.0										

WOODLAND SOILABILITY

CLASS- DETERMINING PHASE	ORD SYM	EROSION MANAGEMENT PROBLEMS				POTENTIAL PRODUCTION		TREES TO PLANT
		EQUIP. HAZARD	SEEDING LIMIT	WINDBL. HAZARD	PCRYT. HAZARD	COMMON TREES	INDEX	
0-152	10	SLIGHT	SLIGHT	SLIGHT	SLIGHT	YELLOW-POPLAR NORTHERN RED OAK WHITE OAK BLACK OAK WHITE ASH	1	EASTERN WHITE PINE NORWAY SPRUCE YELLOW-POPLAR

CLASS- DETERMINING PHASE	NOSE	SPECIES	HT	SPECIES	HT	SPECIES	HT

WILDLIFE HAVEN SOILABILITY

CLASS- DETERMINING PHASE	GRAIN & GRASS SEED		WILD PLANTS		WILDLIFE		POTENTIAL PRODUCTION	
	POOR	POOR	GOOD	GOOD	POOR	POOR	GOOD	POOR
0-82	V. POOR	POOR	GOOD	GOOD	POOR	POOR	GOOD	POOR
0-92	V. POOR	POOR	GOOD	GOOD	POOR	POOR	GOOD	V. POOR
0-152	V. POOR	POOR	GOOD	GOOD	V. POOR	V. POOR	GOOD	V. POOR

POTENTIAL NATIVE PLANT COMMUNITY TARGET AND OF FOREST UNDERSTORY VEGETATION

COMMON PLANT NAME	PLANT SYMBOL (NLSFM)	PERCENTAGE COMPOSITION	CLASS DETERMINING PHASE

POTENTIAL PRODUCTION (LBS./AC. YR.)	FAVORABLE YEARS	NORMAL YEARS	UNFAVORABLE YEARS

FOOTNOTES
 A ESTIMATES OF ENGINEERING PROPERTIES BASED ON TEST DATA OF PEDON FROM MORRIS COUNTY, NEW JERSEY.
 B RATINGS BASED ON GUIDE FOR INTERPRETING ENGINEERING USES OF SOILS, NOV. 1971.
 C RATINGS BASED ON NORTHEAST REGIONAL CRITERIA, MARCH 1966.
 D RATINGS BASED ON SOILS MEMOS 69, OCT. 1968; 26, SEPT. 1967; OR 74, JAN. 1972.

HLRA(S): 144A
REV. WCK, 9-79
ULTIC HAPLUDALS, FINE-LOAMY, MIXED, MESSIC

THE WASHINGTON SERIES CONSISTS OF DEEP, WELL DRAINED SOILS ON UPLANDS. THEY FORMED IN GLACIAL TILL. TYPICALLY THESE SOILS HAVE A DARK YELLOWISH BROWN VERY STONY TOP SURFACE LAYER 9 INCHES THICK. THE STRONG BROWN SUBSOIL FROM 9 TO 17 INCHES IS LOAM AND FROM 17 TO 54 INCHES IS CLAY LOAM. THE SUBSTRATUM FROM 52 TO 72 INCHES IS BROWNISH YELLOW LOAM GRADING TO GRAVELLY SILTY LOAM WITH DEPTH. BEDROCK IS AT 72 INCHES. SLOPES RANGE FROM 0 TO 35 PERCENT.

ESTIMATED SOIL PROPERTIES TABLE											
DEPTH (IN.)	USDA TEXTURE	UNIFIED	AASHTO	PERCENT PERCENT OF MATERIAL LESS THAN 3" PASSING SIEVE NO.					CORROSION CLASS	PLANT INDEX	
				2-10 (PCT)	10-20 (PCT)	20-40 (PCT)	40-60 (PCT)	60-100 (PCT)			
0-9	STO	STO-SIL	CL, SC, SA, RC	A-4, A-6	2-15	30-90	70-80	60-70	40-60	25-40	3-15
9-52	CL, SIL, GR-L	CL, SC, ML, SH	A-4, A-6	A-4, A-6	0-5	75-100	60-95	50-90	35-85	25-40	3-15
52-72	CL, SIL, GR-L	CL, SC	A-4, A-6, A-2, A-1	A-4, A-6	0-15	75-95	35-95	30-85	15-75	25-35	8-15
72	UMB										

DEPTH (IN.)	MOISTURE (PCY)	BULK DENSITY (G/CM3)	PERMEABILITY (IN/HR)	AVAILABLE WATER CAPACITY (IN/IN)	SOIL REACTION (PH)	SACCHARITY (MMHQS/CM)	SWELL POTENTIAL	EROSION FACTORS	TERRACE GROUP	TOPOGRAPHY	CORROSION CLASS	PLANT INDEX
0-9	15-25	1.45	0.8-2.0	0.18-0.22	5.8-7.3	-	LOW	1-4	4	1-4	MODERATE	3-15
9-52	25-35	1.30-1.60	0.6-2.0	0.16-0.20	5.8-7.3	-	LOW	1-4	4	1-4	MODERATE	3-15
52-72	15-30	1.40-1.65	0.6-6.0	0.12-0.16	5.8-7.3	-	LOW	1-4	4	1-4	MODERATE	3-15
72												

FLOODING		HIGH WATER TABLE		CEMENTED PAV		BEDROCK		SUBSTRATUM		HYDROPHOBICITY	
FREQUENCY	DURATION	DEPTH (FT)	KIND	DEPTH (IN)	HARDNESS	DEPTH (IN)	HARDNESS	DEPTH (IN)	HARDNESS	ACT. GAP	FROST ACTION
NONE											

SANITARY FACILITIES (B)		CONSTRUCTION MATERIAL (B)	
SEPTIC TANK ABSORPTION FIELDS	0-8Z: SLIGHT 8-15Z: MODERATE-SLOPE 15-XZ: SEVERE-SLOPE	ROADFILL	0-15Z: POOR-LOW STRENGTH 25-XZ: POOR-SLOPE, LOW STRENGTH
SEWAGE LAGOON AREAS	0-7Z: SEVERE-SEEPAGE 7-XZ: SEVERE-SLOPE, SEEPAGE	SAND	IMPROBABLE-EXCESS FIRES
SANITARY LANDFILL (TRENCH)	0-15Z: SEVERE-SEEPAGE 15-XZ: SEVERE-SLOPE, SEEPAGE	GRAVEL	IMPROBABLE-EXCESS FIRES
SANITARY LANDFILL (AREA)	0-15Z: SEVERE-SEEPAGE 15-XZ: SEVERE-SLOPE, SEEPAGE	TOPSOIL	0-15Z: POOR-LARGE STONES, SMALL STONES 15-XZ: POOR-SLOPE, LARGE STONES, SMALL STONES
DAILY COVER FOR LANDFILL	0-8Z: SLIGHT-TOO CLAYEY, SMALL STONES 8-15Z: FAIR-SLOPE, SMALL STONES, 100 CLAYEY 15-XZ: POOR-SLOPE	POND RESERVOIR AREA	0-8Z: MODERATE-SEEPAGE 3-8Z: MODERATE-SLOPE, SEEPAGE 8-XZ: SEVERE-SLOPE

BUILDING SITE DEVELOPMENT (B)		WATER MANAGEMENT (B)	
SHALLOW EXCAVATIONS	0-8Z: SLIGHT 8-15Z: MODERATE-SLOPE 15-XZ: SEVERE-SLOPE	EMBANKMENTS DIKES AND LEVEES	MODERATE-PIPING
DWELLINGS WITHOUT BASEMENTS	0-8Z: SLIGHT 8-15Z: MODERATE-SLOPE 15-XZ: SEVERE-SLOPE	EXCAVATED PONDS AQUIFER FED	SEVERE-NO WATER
DWELLINGS WITH BASEMENTS	0-8Z: SLIGHT 8-15Z: MODERATE-SLOPE 15-XZ: SEVERE-SLOPE	DRAINAGE	0-3Z: PROBABLY 3-XZ: SLOPE
SMALL COMMERCIAL BUILDINGS	0-1Z: SLIGHT 4-8Z: MODERATE-SLOPE 8-XZ: SEVERE-SLOPE	IRRIGATION	0-3Z: PROBABLY 3-XZ: SLOPE
LOCAL ROADS AND STREETS	0-8Z: MODERATE-FROST ACTION 8-15Z: MODERATE-SLOPE, FROST ACTION 15-XZ: SEVERE-SLOPE	TERRACES AND DIVERSIONS	0-3Z: PROBABLY 8-XZ: SLOPE
SPORTS LANDSCAPING AND GOLF FAIRWAYS	0-8Z: MODERATE-LARGE STONES, SMALL STONES 8-15Z: MODERATE-SLOPE, LARGE STONES, SMALL STONES 15-XZ: SEVERE-SLOPE	GRASSED WATERWAYS	0-3Z: PROBABLY 8-XZ: SLOPE

REGIONAL INTERPRETATIONS	

		RECREATIONAL DEVELOPMENT (C)			
CAMP AREAS	0-5%: MODERATE-SLOPE, LARGE STONES, SMALL STONES, DUSTY 8-15%: MODERATE-SLOPE, LARGE STONES, SMALL STONES 15-25%: SEVERE-SLOPE	PLAYGROUNDS	0-5%: SEVERE-SLOPE, LARGE STONES, SMALL STONES 6-15%: SEVERE-SLOPE, LARGE STONES, SMALL STONES		
PICNIC AREAS	0-5%: MODERATE-SLOPE, LARGE STONES, DUSTY 8-15%: MODERATE-SLOPE, SMALL STONES, LARGE STONES 15-25%: SEVERE-SLOPE	PATHS AND TRAILS	0-15%: MODERATE-SLOPE, LARGE STONES, SMALL STONES 15-25%: MODERATE-SLOPE, LARGE STONES, SMALL STONES 25-35%: SEVERE-SLOPE		

CLASS- DETERMINING PHASE	GRAZING CAPABILITY	15-25%	25-35%	35-45%	45-55%	55-65%	65-75%	75-85%	85-95%	95-100%
0-5%	35	-	-	-	-	-	-	-	-	-
8-15%	65	-	-	-	-	-	-	-	-	-
15-35%	65	-	-	-	-	-	-	-	-	-

CLASS- DETERMINING PHASE	ORD SYM	WOODLAND SUSTAINABILITY (C)				POTENTIAL PRODUCTION		TREES TO PLANT	
		EROSION HAZARD	EQUIV. LIMIT	SEEDLING MORT.	WINDTR. HAZARD	PLANT COMPET.	COMMON TREES		SIZE INDEX
0-5%	10	SLIGHT	SLIGHT	SLIGHT	SLIGHT		NORTHEAST RED OAK	85	EASTERN WHITE PINE
15-35%	12	SLIGHT	MODERATE	SLIGHT	SLIGHT		YELLOW-POPLAR	95	EUROPEAN LARCH BLACK WALNUT YELLOW-POPLAR NORWAY SPRUCE

CLASS- DETERMINING PHASE	SCORE	SPECIES	HT	ADDRESS	SPECIES	HT	SPECIES	HT

CLASS- DETERMINING PHASE	WILDLIFE HABITAT SUSTAINABILITY (C)				POTENTIAL AS HABITAT FOR			
	GRAZ. SEED	GRASS LEGUME	WILD HERB TREES	WILDLIFE PLANTS	WETLAND PLANTS	WATER WILDLIFE	WOODLAND WILDLIFE	WETLAND WILDLIFE
0-5%	V. POOR	POOR	GOOD	GOOD				
15-35%	V. POOR	POOR	GOOD	GOOD	POOR	V. POOR	POOR	GOOD

POTENTIAL NATIVE PLANT	COMMON PLANT NAME	PLANT SYMBOL	PERMANENT CUMULATIVE DRY WEIGHT % CLASS DETERMINING PHASE

POTENTIAL PRODUCTION YEARS	FAVORABLE YEARS	NORMAL YEARS	UNFAVORABLE YEARS

FOOTNOTES
 A ESTIMATES OF ENGINEERING PROPERTIES BASED ON TEST DATA OF 10 PEDONS FROM PENNSYLVANIA.
 B RATINGS BASED ON NSH, PART II, SECTION 403, 3-78.
 C RATINGS BASED ON SOILS MEMO 22, SEPT 1967 AND REGIONAL CRITERIA. SITE INDEX VALUES + OR -5 OR MORE.
 D WILDLIFE RATINGS BASED ON SOILS MEMO 74, JAN 1972.
 E EXCESSIVE PERMEABILITY RATE MAY ALLOW POLLUTION OF GROUND WATER.

MLRA(S): 147, 148, 126, 127, 124
 REV. GML 9-83
 TYPIC DISTROCHREPTS, LOAMY-SKELETAL, MIXED, MESIC

THE HAZLETON SERIES CONSISTS OF DEEP, WELL DRAINED SOILS ON UPLANDS. THEY FORMED IN MATERIAL WEATHERED FROM SANDSTONE. TYPICALLY, THESE SOILS HAVE A DARK BROWN SANDY LOAM SURFACE LAYER, 6 INCHES THICK. THE SUBSOIL BETWEEN 6 AND 32 INCHES IS REDDISH-YELLOW TO STRONG BROWN CHANNERY AND VEILY CHANNERY SANDY LOAM. THE SUBSTRATUM FROM 32 TO 56 INCHES IS REDDISH-YELLOW VEILY CHANNERY SANDY LOAM. SANDSTONE BEDROCK IS AT A DEPTH OF 56 INCHES. SLOPES RANGE FROM 0 TO 90 PERCENT.

ESTIMATED SOIL PROPERTIES (A)										
DEPTH (IN.)	USDA TEXTURE	UNIFIED	AASHTO			PERCENT OF MATERIAL LESS THAN 2" PASSING SIEVE NO.				LOGIC CLASS
						10	20	40	60	INDEX
0-6	SC, C, ESL	ML	A-4			0-5	90-100	90-100	75-90	65-75
6-32	CM-SL, CM-L	ML, GM, SM	A-2, A-4			0-15	60-85	60-80	60-75	35-55
32-56	CM-SL, CMU-L	GM, SM, ML, SC	A-2, A-4, A-1			0-50	60-95	45-90	35-70	10-55
56	UMB	GR, SR, SC, GC	A-2, A-1, A-4			0-60	55-80	35-75	25-65	15-60

DEPTH (IN.)	CLAY (%)	MOISTURE (%)	DENSITY (G/CM3)	PERMEABILITY (M/HR)	WATER CAPACITY (IN/IN)	SOIL REACTION (PH)	SALINITY (MMHGS/CM)	SHRINK-SWELL POTENTIAL (%)	TEXTURE GROUP	TOPOGRAPHIC GROUP	ORGANIC MATTER (%)	CORROSION
0-6	7-18	1.20-1.40	1.40	2.0-8.0	0.12-0.18	3.8-5.3	-	LOW	1-1	1	1-4	LOW
6-32	7-18	1.20-1.40	1.40	2.0-8.0	0.10-0.14	3.8-5.3	-	LOW	1-1	1	1-4	LOW
32-56	5-15	1.20-1.40	1.40	2.0-8.0	0.08-0.12	3.8-5.3	-	LOW	1-1	1	1-4	LOW

FLOODING		HIGH WATER TABLE		DEGRADED PAV		YIELDING		SUBSISTENCE		TRUCK POTENTIAL	
FREQUENCY	DURATION	MONTHS	DEPTH (FT)	MIN	MAX	DEPTH (IN)	HARDNESS	DEPTH (IN)	GROUP	DEPTH (IN)	ACTION

SANITARY FACILITIES (B)		CONSTRUCTION MATERIAL (C)	
SEPTIC TANK ABSORPTION FIELDS	0-15% SEVERE-POOR FILTER 15+% SEVERE-POOR FILTER, SLOPE	ROADFILL	0-15% FAIR-POOR RECLAIM, THIN LAYER, LARGE STONES 15-35% FAIR-SLOPE, AREA RECLAIM, THIN LAYER 35+% POOR-SLOPE
SEWAGE LAGOON AREAS	0-7% SEVERE-SEEPAGE 7+% SEVERE-SLOPE, SEEPAGE	SAND	IMPROBABLE-EXCESS FIRES
SANITARY LANDFILL (TRENCH)	0-15% SEVERE-SEEPAGE, DEPTH TO ROCK 15+% SEVERE-SLOPE, SEEPAGE, DEPTH TO ROCK	GRAVEL	IMPROBABLE-EXCESS FIRES
SANITARY LANDFILL (AREA)	0-15% SEVERE-SEEPAGE 15+% SEVERE-SLOPE, SEEPAGE	TOPSOIL	0-15% POOR-SMALL STONES 15+% POOR-SLOPE, SMALL STONES
DAILY COVER FOR LANDFILL	0-15% POOR-SMALL STONES 15+% POOR-SLOPE, SMALL STONES	POND RESERVOIR AREA	0-8% SEVERE-SEEPAGE 8+% SEVERE-SEEPAGE, SLOPE
SHALLOW EXCAVATIONS	0-8% MODERATE-DEPTH TO ROCK, LARGE STONES 8-15% MODERATE-DEPTH TO ROCK, SLOPE, LARGE STONES 15+% SEVERE-SLOPE	EMBANKMENTS, DICES AND LEVEES	SEVERE-SEEPAGE, LARGE STONES
DWELLINGS WITHOUT BASEMENTS	0-8% MODERATE-LARGE STONES 8-15% MODERATE-SLOPE, LARGE STONES 15+% SEVERE-SLOPE	EXCAVATED PONDS, AQUIFER FED	SEVERE-NO WATER
DWELLINGS WITH BASEMENTS	0-8% MODERATE-LARGE STONES, DEPTH TO ROCK 8-15% MODERATE-SLOPE, LARGE STONES, DEPTH TO ROCK 15+% SEVERE-SLOPE	DRAINAGE	DEEP TO WATER
SMALL COMMERCIAL BUILDINGS	0-8% MODERATE-LARGE STONES 4-8% MODERATE-SLOPE, LARGE STONES 8+% SEVERE-SLOPE	IRRIGATION	0-3% LARGE STONES, DROUGHTY 3+% LARGE STONES, DROUGHTY, SLOPE
LOCAL ROADS AND STREETS	0-8% MODERATE-FROST ACTION, LARGE STONES 8-15% MODERATE-SLOPE, FROST ACTION, LARGE STONES 15+% SEVERE-SLOPE	TERRACES AND DIVERSIONS	0-8% LARGE STONES, TOO SANDY 8+% SLOPE, LARGE STONES, TOO SANDY
DRIVEWAYS AND GOLF FAIRWAYS	0-8% SL, ESL, MODERATE-DROUGHTY 0-8% CM, MODERATE-SMALL STONES, DROUGHTY 8-15% SL, ESL, MODERATE-SLOPE, DROUGHTY 8-15% CM, MODERATE-SLOPE, SMALL STONES 15+% SEVERE-SLOPE	GRASSED WATERWAYS	0-8% LARGE STONES, DROUGHTY 8+% LARGE STONES, SLOPE, DROUGHTY

RECREATIONAL DEVELOPMENT (B)

CAMP AREAS	0-8% SL. L. ESL: SLIGHT 0-8% CM: MODERATE-SMALL STONES 8-15% SL. L. ESL: MODERATE-SLOPE 8-15% CM: MODERATE-SLOPE, SMALL STONES 15+% SEVERE-SLOPE	PLAYGROUNDS	7-22 SL. L. ESL: SLIGHT 7-22 SL. L. ESL: MODERATE-SLOPE 6+% SL. L. ESL: SEVERE-SLOPE 0-8% CM: SEVERE-SMALL STONES 8+% CM: SEVERE-SMALL STONES, SLOPE
PICNIC AREAS	0-8% SL. L. ESL: SLIGHT 0-8% CM: MODERATE-SMALL STONES 8-15% SL. L. ESL: MODERATE-SLOPE 8-15% CM: MODERATE-SLOPE, SMALL STONES 15+% SEVERE-SLOPE	PATHS AND TRAILS	0-15% SLIGHT 15-25% MODERATE-SLOPE 25+% SEVERE-SLOPE

CLASS- DETERMINING PHASE	CORN AND YIELDS PER ACRE OF CROPS AND PASTURE						HIGH TREES MANAGEMENT							
	CORN		SWEET CORN		GRASS		ALDER		LEGUMES		PASTURE		CORN SILAGE	
	YIELD (BU)	YIELD (BU)	YIELD (BU)	YIELD (BU)	YIELD (BU)	YIELD (BU)	YIELD (TONS)	YIELD (TONS)	YIELD (TONS)	YIELD (TONS)	YIELD (TONS)	YIELD (TONS)	YIELD (TONS)	YIELD (TONS)
0-8%	22	125	45	75	4.5	3.5	4.5	3.5	3.5	8.0	8.0	8.0	8.0	8.0
8-15%	38	115	40	70	4.5	3.5	4.5	3.5	3.5	8.0	8.0	8.0	8.0	8.0
15-25%	46	110	35	60	4.0	3.0	4.0	3.0	3.0	7.5	7.5	7.5	7.5	7.5
25+%	7E	-	-	-	-	-	-	-	-	7.0	7.0	7.0	7.0	7.0

CLASS- DETERMINING PHASE	UND. SYM.	EXISTING MANAGEMENT PROBLEMS					POTENTIAL PRODUCTION				
		EROSION HAZARD	EQUIP. LIMIT	SEEDLING MORTALITY	WINDROT HAZARD	FEARY GRASS	NORTHERN RED OAK	YELLOW-POPLAR	COMMON TREES	TREES TO PLANT	
0-8%	3E	SLIGHT	SLIGHT	SLIGHT	SLIGHT	MODERATE	NORTHERN RED OAK	70	70	JAPANESE LARCH	
15-35% NORTH	3E	SLIGHT	MODERATE	SLIGHT	SLIGHT	MODERATE	YELLOW-POPLAR	80	80	EASTERN WHITE PINE	
35+% NORTH	3E	MODERATE	SEVERE	SLIGHT	SLIGHT	MODERATE	NORTHERN RED OAK	80	80	NORWAY SPRUCE	
15-35% SOUTH	4E	SLIGHT	MODERATE	MODERATE	SLIGHT	SLIGHT	NORTHERN RED OAK	80	80	AUSTRIAN PINE	
35+% SOUTH	4E	MODERATE	SEVERE	SEVERE	SLIGHT	SLIGHT	BLACK OAK	60	60	BLACK CHERRY	

CLASS- DETERMINING PHASE	SPECIES	YIELD	SPECIES	YIELD	SPECIES	YIELD
ALL	SIBERIAN PEASBUD	8	WASHINGTON HORN	9	ADONIS	8
	AUTUMN-OLIVE	9	AUSTRIAN PINE	16	RED PINE	18
	JACK PINE	16				20

CLASS- DETERMINING PHASE	POTENTIAL WILDLIFE HABITAT SUITABILITY							
	GRAIN	GRASS	WILD HERB	WILDLIFE PLANTS	WILDLIFE SHRUBS	WILDLIFE TREES	WILDLIFE WATER	WILDLIFE WILDLIFE
0-8%	GOOD	GOOD	GOOD	GOOD	GOOD	GOOD	GOOD	GOOD
8-15%	FAIR	GOOD	GOOD	GOOD	GOOD	GOOD	GOOD	GOOD
15-25%	POOR	FAIR	GOOD	GOOD	GOOD	GOOD	GOOD	GOOD
25-35%	V. POOR	FAIR	GOOD	GOOD	GOOD	GOOD	GOOD	GOOD
35+%	V. POOR	POOR	GOOD	GOOD	GOOD	GOOD	GOOD	GOOD

COMMON PLANT NAME	PLANT SYMBOL (NLSPN)	POTENTIAL NATIVE PLANT COMMUNITY		POTENTIAL NATIVE PLANT COMMUNITY	
		WETLANDS	WETLANDS	WETLANDS	WETLANDS

POTENTIAL PRODUCTION YEARS/AC. DRY YEAR	FAVORABLE YEARS	NORMAL YEARS	UNFAVORABLE YEARS

FOOTNOTES
 A ESTIMATES OF ENGINEERING PROPERTIES BASED ON TEST DATA OF 16 PEDONS FROM PENNSYLVANIA.
 B RATINGS BASED ON NSH, PART II, SECTION 403, 3-78.
 C RATINGS BASED ON SOILS MEAS 26, SEPT. 1967; OR 74, JAN. 1972.

2. Required: For this site, estimate the Topographic Factor
"LS"

Solution:

"LS" for Subarea "A" (11.6 acres)

Segment No.	Slope %	"LS" form Table A1-3	Adjustment Factor	Segment "LS"
1	1	0.21	0.71	0.15
2	2	0.33	1.29	0.43
Average LS:				0.29

Subarea A will have original slope

"LS" for Subarea "B" (27.0 acres)

Segment No.	Slope %	"LS" form Table A1-3	Adjustment Factor	Segment "LS"
1	1	0.27	0.45	0.12
2	2	0.41	0.82	0.34
3	0.2 *	0.17	1.06	0.18
4	0.2 **	0.17	1.25	0.21
5	5	1.70	1.42	2.41
Average LS:				0.65

$$\text{Weighted LS} = [(0.29)(11.6) + (0.65)(27.0)] / 38.6 = 0.54 \text{ (answer)}$$

Note:

Subarea B will be reshaped for construction. Assume that the building area is almost horizontal around 96-ft. elevation.

3. Required: Estimate the annual soil erosion rate from the construction site without any control measure. At what rate will this sediment be arriving at the Winding Creek?

Solution:

1. Using the Universal Soil Loss Equation $E = R K LS C P$

R: from Figure A1-1, R value in Hunterdon County is 175

Universal Soil Loss Equation

A1-17

1. (cont'd)

K: weighted K value previously calculated is 0.23 t/ac

LS: weighted LS factor previously calculated is 0.54

C: no cover, therefore C is 1.0

P: no control practices, P = 1.0

2. The estimated average soil loss from sheet erosion (E) in tons per acre per year is:

$$E = (175) (0.23) (0.54) (1.0) (1.0) \\ 22 \text{ tons/acre/year}$$

3. The erosion from the entire site (sediment yield)

$$22 \text{ tons/acre/year} \times 38.6 \text{ acres} = 849 \text{ tons/year}$$

4. Delivery Ratio (DR): The Winding Creek is about 600 feet downstream of the construction site. Based on the values given previously assume DR = 0.7

5. Sediment reaching the Winding Creek is:

$$0.7 \times 849 \text{ tons/year} = 594 \text{ tons/year (answer)}$$

4. Required: What would the soil erosion be for an extreme year of one in 20 years and for a major single storm of one in 20 years?

Solution:

1. Soil erosion for an extreme year of one in 20 years can be determined as follows:

a. Probability factor of one in 20 years (table A1-8) is 1.7

b. Soil erosion for this year is 1.7×849 tons/year or 1443 tons/year (answer)

2. Soil Erosion for a major storm of one in 20 years can be determined as follows:

- a. The factor in table A1-8 is 0.7, therefore the soil erosion for the storm is 0.7×849 tons/year or 594 tons/year (answer).

5. Required: What would the reduction of annual soil erosion be (in percent) if the slope length is divided into five equal slope lengths by using diversions? What would the reduction be if straw or hay mulch at a rate of 1.5 T/ac is properly used in each of the above slope length segments?

Solution:

1. Divide the slopes into five equal slope lengths (figure A1-2) and determine the effect of the slope length change:

Each slope-length will be 210 feet. "LS" factor, as well as the erosion rate, for each slope-length is computed individually.

Erosion from Subarea A

Segment No.	Slope (%)	"LS" from Table A1-3	Area A (acres)	Annual Soil Loss ARKLS (tons/year)
1	1	0.16	2.32	14.9
2	1	0.16	2.32	14.9
3	2	0.25	2.32	23.3
4	2	0.25	2.32	23.3
5	2	0.25	2.32	23.3

Total from Subarea A is 100 tons/year

Erosion from Subarea B

Segment No.	Slope (%)	"LS" from Table A1-3	Area B (acres)	Annual Soil Loss ARKLS (tons/year)
1	1	0.16	5.4	34.8
2	2	0.25	5.4	54.3
3	0.2	0.10	5.4	21.7
4	0.2	0.10	5.4	21.7
5	5	0.78	5.4	169.5

Total from Subarea B is 302 tons/year

Therefore the total soil loss is $100 + 302 = 402$ tons/year.
The percent reduction would therefore be $(849-402)/849 \times 100 = 53$ percent (answer)

2. The soil loss reduction from the slope length change and from adding mulch is as follows:

- a. From table A1-4 for slopes that are ≤ 5 percent and lengths less than 300 feet, the cropping management factor (C) is 0.12
- b. Soil loss with straw or hay mulch (1.5 tons/year) on the five equal segments is $402 \text{ tons/year} \times 0.12 = 48 \text{ tons/year}$
- c. Reduction of annual soil loss $(849-48)/849 \times 100$ or 94 percent (answer)

6. Required: Assume that the only control measure adopted in this site is a sediment basin which will be constructed at the downstream edge of the property. For what sediment volume will this basin be designed?

Solution:

1. Since the sediment basin will be built at the downstream edge of the site, $DR = 1.0$

2. The rate of sediment which will enter the basin is 849 tons/year.

3. The adjustment factor, M (table A1-6), for the 18 month construction period (April 1, 1986 to September 30, 1987):

April 1, 1986 to March 1, 1987: $M = 0.98$

March 1, 1987 to October 1, 1987 $M = 0.82$

Total $M = 1.80$

4. Total sediment which will arrive at the basin during the construction period is $E_t = 849 \text{ tons/year} \times 1.80$ or 1528 tons.

5. Using Table A1-7, the saturated sediment volume for which the sediment basin will be designed is:

$1528 \times .00077 = 1.18$ acre-feet

or

$1528 \times 1.24 = 1895$ cu. yd. (answer)

FIGURE A1-1

RAINFALL EROSION VALUES "R"
NEW JERSEY MAP

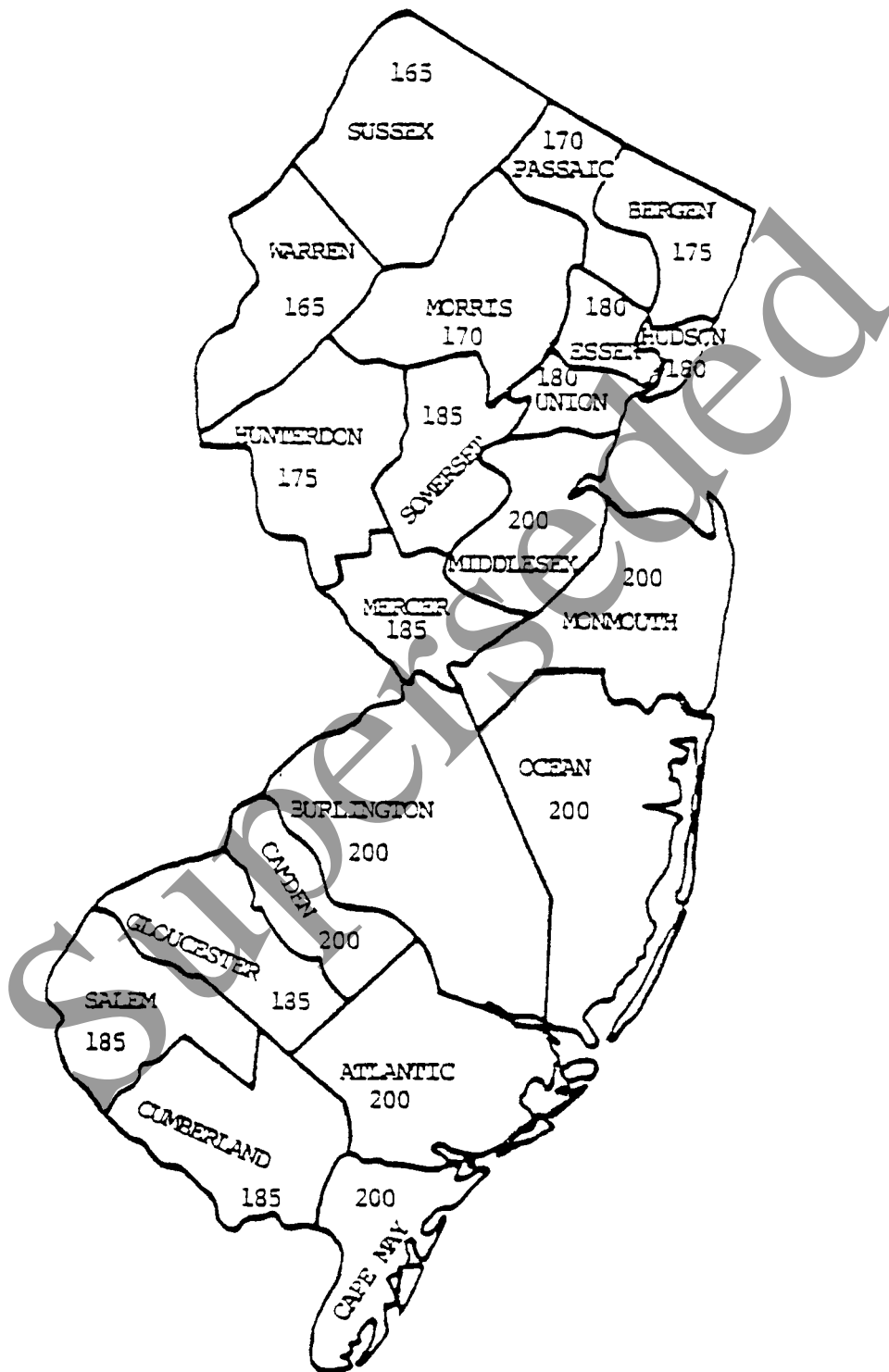

TABLE A1-1

USDA TEXTURE ABBREVIATIONS USED IN TABLE A1-2a, A1-2b, A1-2c

c	-	clay, clayey
ch	-	channery
co	-	coarse
e	-	extremely
f	-	fine
g	-	gravelly
k	-	cobbly
l	-	loam, loamy
m	-	muck
r	-	rocky
s	-	sand, sandy
sh	-	shaly
si	-	silt, silty
st	-	stony
v	-	very

SOIL-ERODIBILITY CLASSES

K	-	class
0.17 - 0.24	-	low
0.28 - 0.37	-	medium
0.43 - 0.49	-	high

TABLE A1-2a EROSION PROPERTIES OF SOILS IN NEW JERSEY
LAND RESOURCE AREA 144, R-175

<u>Soil Series</u> (Alpha Listing)	<u>Local</u> ^{1/} <u>Mapping</u> <u>No.</u>	<u>Typical</u> <u>Profile</u> (inches)	<u>USDA</u> <u>Texture</u> <u>Range</u>	<u>Unified</u> <u>System</u>	<u>K</u>	<u>KR</u>
Adrian		0-42	m	Pt	-	-
		42-60	ls	SP-SM, SM	0.2	35
Albia		0-16	gl, estl	GM, GC, SC	0.24	42
		16-40	gl (pan)	GM, GC, SC	0.4	70
		40-60	gl	GM, GC, SC	0.3	53
Asbury		0-30	sil	GL, ML	^{2/}	-
		30-60	ls, gls, vgl	SM, GM	-	-
Atherton		0-30	l	SM, SC, ML, CL	0.24	42
		30-60	scl	SM, SC	0.2	35
Bartley		0-11	l, g	ML, CL	0.32	56
		11-32	cl, l, scl	ML, CL	0.3	53
		32-42	sl, l	SM, SC	0.2	35
		42-60	sl, l, gsl, gl	SM, SC	0.2	35
Bath		0-28	l, sil	SM, SC	0.24	42
			gl, vstl	GM, GC	0.17	30
		28-48	l, sil	SM, SC	0.2	35
			gl, gsl	GM, GC	0.2	35
Beatty		0-25	l	CL, ML	^{2/}	-
		25-60	ls, gls	SM, GM	-	-
Biddeford		0-8	ml	Pt	-	-
		8-18	sil	ML, CL	-	-
		18-44	sicl, c, cl	CL, CH	-	-
		44-60	sil, cl, sicl	ML, CL	-	-
Boonton		0-6	gl, estl	ML	0.20	35
		6-30	fsl, l, sil,	ML, CL	0.2	35
			gfsl, gl, gsil			
		30-45	fsl, sil, gfsl, ML, CL, SM, SC		0.2	35
Braceville		45-60	gsil		0.2	35
			gsl	SM		
		0-24	gsl	SM, GM	0.24	42
		24-36	g or vg, l, sl	SM, SC, GM	0.3	53
Bridgeville		36-60	stratified	SM, SP, SP-SM, GP	0.2	35
			scg			
Burnham		0-30	sl, gl	SM	0.24	42
		30-60	gl, g, s	SM	0.2	35
Burnham		0-12	l, sil	ML, CL	0.32	26
		12-48	gl	ML, CL	0.3	53
		48-60	stone, g	SM, SC, GM, GC	0.2	35

^{1/} Mapping units may be inserted on the basis of the local county soil survey.
^{2/} Alluvial soil, unassigned.

TABLE A1-2a EROSION PROPERTIES OF SOILS IN NEW JERSEY
LAND RESOURCE AREA 144, R=175

Soil Series (Alpha Listing)	Local ^{1/} Mapping No.	Typical Profile (inches)	USDA Texture Range	Unified System	K	KR
Carlisle		0-60	m	Pt	-	-
Cattaraugus		0-20	fsl	SM,ML,CL	0.24	42
			gl	SM,ML,CL	0.17	30
		20-60	fsl (pan)	SM,ML,CL	0.3	53
Chatfield		0-28	l	ML,CL	0.17	30
		28+	gneiss bedrock			
Chenango		0-20	sl	SM	0.24	42
			gfsl,ksl	GM	0.17	30
		20-30	vgsl,gsl	SM,GM	0.2	35
		30-60	g,s,gl	GP-GM,GM	0.2	35
Chippewa		0-13	sil	ML,CL	0.32	56
			chsil,estl	ML,CL	0.24	42
		13-50	l,chsil (pan)	ML,CL,GM	0.4	70
Colden		0-8	sil	ML,CL	0.43	75
		8-45	sicl	ML	0.4	70
Colonie		0-16	lfs,ls	SM,SP-SM	0.24	42
		16-60	fs,ls,lfs	SM,SP-SM	0.2	35
Comly		0-11	sil	ML,CL	0.37	65
		11-20	sicl,l,sil	ML,CL,CH	0.4	70
		20-27	sicl (pan)	ML,CL,CH	0.5	88
		27-40	sil,l,sicl	ML,CL,CH	0.3	53
Coplay		0-10	sil	ML,CL	0.32	56
		10-60	sicl,cl	ML,CL	0.3	53
Cossayuna		0-24	l,vfsl	SM,ML,CL	0.24	42
			gl	SC,GM,GC	0.17	30
		24-48	g,gl (pan)	SC,GM,GC,SM,ML	0.3	53
		48-60	gsl	SM,GM	0.2	35
Crestmore		0-30	l,sil	ML,CL	0.32	56
		30+	bedrock			
Culvers		0-16	fsl	SM,ML,CL	0.28	49
			chsil	SM,ML,CL	0.20	35
		16-45	l	ML	0.3	53
			chsil	ML,CL,GM	0.3	53
Dutchess		0-60	sil,l,shl, shsil	GM,SM	0.20	35
Ellington		0-15	l,fsl	ML,SM	0.24	42
			gl,gsl	ML,SM	0.24	42
		15-38	l,sl	ML,SM	0.3	53
			gl,gsl	ML,SM	0.2	35
	38-60	s,gs	SM,SP-SM,GM	0.2	35	

^{1/} Mapping units may be inserted on the basis of the local county soil survey.

TABLE A1-2a EROSION PROPERTIES OF SOILS IN NEW JERSEY
LAND RESOURCE AREA 144, R=175

Soil Series (Alpha Listing)	Local ^{1/} Mapping No.	Typical Profile (inches)	USDA Texture Range	Unified System	K	KR
Fredon		0-7	l	ML,CL,SM	0.24	42
		7-30	sl,fsl	SM,ML,CL	0.3	53
			gsl,gfsl	SM,ML,CL	0.2	35
		30-60	s,g	GP-GM,SP-SM	0.2	35
Hackettstown		0-30	sl	SM	0.24	42
			gsl	SM,GM	0.17	30
		30-60	gls,gsl	SM,GM	0.2	35
Haledon		0-10	sil,gsil	ML,CL	0.32	56
		10-46	sil,l,fsl, gsil,gl,gfsl	ML,CL	0.3	53
			vfsl,sl,gvfsl	SM,SC	0.2	35
		46-60	gsl			
Halsey		0-24	l	ML,SM	0.24	42
		24-30	fsl,l,sl	SM	0.3	53
		30-60	g,gs,s & g	GP,GM,SM,SP	0.2	35
Hazen		0-12	gsl,gl	ML,CL	0.17	30
		12-32	gl	ML,CL	0.2	35
		32-60	g & s	SM	0.2	35
Hero		0-10	l	SM,ML,CL	0.24	42
		10-24	fsl,gsl	SM	0.2	35
		24-60	s,gs	SM,GM	0.2	35
Hibernia		0-25	l	ML,CL,SM,SC	0.37	65
			gl,sl,vstl	ML,CL,SM,SC	0.32	56
		25-36	l,scl,sl, gl,gscl,gsl	ML,CL,SM,SC	0.3	53
		36-72	gls,gsl,kls	SM,SC,GM,GC	0.3	53
Holyoke		0-17	rsil	ML,CL	0.24	42
		17+	Bedrock			
Hoosic		0-15	gl,gsl	SM,GM,ML,CL	0.17	30
		15-26	gsl,vgsl	GM,SM,ML,CL	0.2	35
		26-60	s & g	SW,GW,SM,GM, SP,GP	0.2	35
Kendaia		0-8	sil,l,fsl	ML	0.28	49
		8-20	sil,l	ML,ML-CL	0.4	70
			sil,l	ML-CL,ML,SM	0.4	70
		20-40		ML-CL,ML,SM GM-GC	0.3	53
Kistler		0-14	shsil	ML,CL	0.24	42
		14-24	vshsil	ML,CL,GM	0.2	35
		24+	slate bedrock			
Lackawana		0-26	l	ML,CL	0.24	42
			chsil	ML,CL	0.17	30
		26-52	chl(pan)	ML,CL	0.3	53

^{1/} Mapping units may be inserted on the basis of the local county soil survey.

TABLE A1-2a EROSION PROPERTIES OF SOILS IN NEW JERSEY
LAND RESOURCE AREA 144, R-175

<u>Soil Series</u> (Alpha Listing)	<u>Local 1/</u> <u>Mapping</u> <u>No.</u>	<u>Typical</u> <u>Profile</u> <u>(inches)</u>	<u>USDA</u> <u>Texture</u> <u>Range</u>	<u>Unified</u> <u>System</u>	<u>K</u>	<u>KR</u>
Livingston		0-10	si,sicl	ML,CL	0.49	86
		10-50	sic	ML,CL MH,CH	0.5	88
Lyons		0-9	vstsil	CL,ML,SM,SC	0.28	49
		9-18	sil,fsl,sicl	SM,SC,GM,GC, ML,CL	0.4	70
		18-40	fsl,cl	SM,SC,ML,CL	0.4	70
		40-60	gl	ML,CL,GM,GC	0.3	53
Marksboro		0-10	l	ML,CL	0.24	42
			gl	ML,CL,SM,SC	0.24	42
		10-40	l,gsl	SM,SC	0.4	70
Menlo		0-22	l	ML,CL	0.24	42
			gl	ML,CL	0.24	42
		22-40	gl(pan)	SM,SC	0.5	88
Middlebury		0-10	fsl	SM,SC,ML	0.24	42
		10-50	fsl,sil	SM,SC,ML	0.4	70
Minoa		0-30	sil,fsl	ML,CL,SC	0.28	49
		30-60	lfs,sil,lvfs	SM	0.2	35
Nassau		0-7	shsil, chsil,SM,GM		0.20	35
			vsil			
		7-16	chsil,vchsil	SM,SC,GM,GC	0.2	35
		16+	shsil,vshsil shale bedrock			
Netcong		0-60	gsl,sl	SM,SC	0.24	42
Norwich		0-6	sil	ML,CL	0.32	56
			vstsil	ML,CL	0.28	49
		6-30	chsicl	ML,CL	0.3	53
		30-60	vchsil	ML,CL	0.3	53
Oquaga		0-16	vstsl,estl	SM	0.20	35
		16-26	stsl	SM	0.3	53
		26+	Bedrock			
Otisville		0-10	sl,gsl,gl	SM,SP-SM,GP-GM	0.17	30
		10-60	gl,gs GP-GM	SM,SP-SM,GM,	0.2	35
Palmyra		0-18	sil,gfsl	ML,CL	0.24	42
		18-24	sil	ML,CL	0.2	35
		24-40	g & s	SM	0.2	35

1/ Mapping units may be inserted on the basis of the local county soil survey.

TABLE A1-2a EROSION PROPERTIES OF SOILS IN NEW JERSEY
LAND RESOURCE AREA 144, R=175

<u>Soil Series</u> (Alpha Listing)	<u>Local 1/</u> <u>Mapping</u> <u>No.</u>	<u>Typical</u> <u>Profile</u> (inches)	<u>USDA</u> <u>Texture</u> <u>Range</u>	<u>Unified</u> <u>System</u>	<u>K</u>	<u>KR</u>
Parsippany		0-7	sil	ML,CL	0.43	75
		7-34	cl,sicl,sic	ML,CL,CH	0.4	70
		34-60	sicl,cl,l	ML,CL,CH	0.4	70
Paulina		0-21	l,shl	ML,CL	0.28	49
		21-38	shl	ML,CL	0.2	35
Phelps		0-21	fsl	SM	0.24	42
		21-45	sl	SM	0.3	53
		45-50	g & s	SM	0.2	35
Pompton		0-28	sl,fsl	SM	0.24	42
		28-60	s & g	SM,GM	0.2	35
Preakness		0-12	sl,l	SM	0.28	49
		12-30	sl	SM	0.2	35
		30-60	ls,sl	SM,SP-SM	0.2	35
			gls	GM,SP-SM	0.2	35
Raynham		0-28	sil	ML,CL	0.49	86
		28-60	sil,vfsl	ML,CL	0.4	70
Red Hook		0-10	fsl	SM,SC	0.24	42
		10-35	sil	ML,CL	0.4	70
		35-60	ls	SM	0.4	70
Rhinebeck		0-12	sil,sicl	ML,CL,OL	0.49	86
		12-30	sicl,sic	CL,ML	0.4	70
		30-40	sicl,sil,vfsl	CL,ML	0.5	88
Ridgebury		0-16	sl,fsl,l	SM,ML,SC	0.24	42
			vstl,estl	SM,ML,SC	0.24	42
		16-40	gl,gsl	SM,SC	0.3	53
		40-60	gs,s	SM,GM	0.2	35
Riverhead		0-9	sl	SM,SC	0.28	49
			gsl	SM,SC	0.20	35
		9-34	fsl,slgsl,	SM,SC	0.3	53
		34-60	ls,s,gls,gs	SP-SM,SM,GP-GM GM	0.2	35
Rockaway		0-30	l	ML,SM,SC	0.24	42
			gsl,gl,vstl,	ML,SM,SC	0.17	30
			vstsl,estsl			
	30-60	gsl	SM,SC	0.2	35	
Rockport		0-10	shsil	ML,CL	0.20	35
		10-36	sicl,sic	ML,CL,MH CH	0.4	70
		Rock				
Roe		0-10	l	ML,CL	0.24	42
		10-36	l,sil	ML,CL	0.3	53
		36-60	fs	SM	0.2	35

1/ Mapping units may be inserted on the basis of the local county soil survey.

TABLE A1-2a EROSION PROPERTIES OF SOILS IN NEW JERSEY
LAND RESOURCE AREA 144, R=175

<u>Soil Series</u> (Alpha Listing)	<u>Local</u> <u>Mapping</u> <u>No.</u>	<u>1/</u>	<u>Typical</u> <u>Profile</u> <u>(Inches)</u>	<u>USDA</u> <u>Texture</u> <u>Range</u>	<u>Unified</u> <u>System</u>	<u>K</u>	<u>KR</u>
Scio			0-40	sil	ML,CL	0.49	86
			40-60	sl	SM	0.3	53
Sloan			0-45	sil,sicl	ML,CL	-	-
			45-60	gsl	SM		
Stephensburg			0-19	shl	ML	0.28	49
			19-26	vshl	GM,SM	0.2	35
			26+	shale bedrock		-	-
Swartswood			0-30	gfsl,gl,vstsl	SM,SC	0.17	30
			30-60	gfsl(pan)	SM,SC	0.3	53
Townsbury			0-13	l	SM,ML	0.24	42
				vstl	SM,ML	0.17	30
			13-36	l	SM,ML,SC	0.4	70
				gl	SM,ML,SC	0.2	53
			30-60	gsl	SM	0.2	35
Tunkhannock			0-18	gl,vgl	SM,GM,ML	0.17	30
			18-32	vgsl	GM,SM	0.2	35
			32-60	s,gs	SM,GMSP,GP	0.2	35
Unadilla			0-10	vfsl	ML,CL	0.49	86
			10-60	sil,vfsl	ML,CL	0.4	70
			60-70	g & s	SP-SM,GP-GM, GW-GM	0.3	53
Valois			0-60	shl	ML,CL	0.17	30
Wallkill			0-8	sil	OL,CL,ML,SM,SC	0.32	56
			8-23	sil	CL,ML,SM,SC	0.4	70
			23-60	muck & peak	OL,Pt	0.4	70
Washington			0-9	l,sil	ML,CL	0.32	56
				vstl	ML,CL	0.28	49
			9-60	l,sicl,cl	ML,CL	0.3	53
Jessaic			0-14	sil,l	ML,CL	0.32	56
				gl,gsl	SM,SC,GM,GC	0.24	42
			14-23	l,sl	SM,SC,ML,CL	0.3	53
				gsil	GM,GC	0.2	35
			23+	Bedrock			
Wayland			0-7	sil	OL-ML,CL	0.32	56
			7-38	sil	ML,CL	0.5	88
			38-50	stratified sil & fsl	ML,CL,SC,SM,GM, GC	0.4	70
Wellsboro			0-11	sil,fsl,l	SM,ML,CL	0.28	49
				chsil	SM,ML,CL	0.20	35
			11-22	l,sil	ML,CL	0.3	53
			22-60	fsl,sil,gl (pan)	SM,SC,ML,CL	0.3	53

1/ Mapping units may be inserted on the basis of the local county soil survey.

Universal Soil Loss Equation

TABLE A1-2a EROSION PROPERTIES OF SOILS IN NEW JERSEY
LAND RESOURCE AREA 144, R=175

<u>Soil Series</u> (Alpha Listing)	<u>Local</u> <u>Mapping</u> <u>No.</u>	<u>1/</u> <u>Typical</u> <u>Profile</u> <u>(Inches)</u>	<u>USDA</u> <u>Texture</u> <u>Range</u>	<u>Unified</u> <u>System</u>	<u>K</u>	<u>KR</u>	
Whippany		0-9	sil	ML,CL	0.43	75	
		9-60	sil,sicl,sic,c	ML,CL,CH	0.4	70	
Whitman		0-10	fsl,sl,lvfsl	OL,SM,ML	0.24	42	
			vstl,estsl		0.24	42	
		10-40	fsl,sl,l	SM,ML-CL	0.2	35	
		40-60	gsl	SM	0.2	35	
Woodglen		0-10	l	ML,CL	0.49	86	
		10-36	sicl,c	ML,CL,MH,CH	0.4	70	
		36-60	l,cl	ML,CL	0.4	70	
Wooster		0-32	l,sil,cl	ML,CL	0.32	56	
			gl,chl,gsil	ML,CL	0.3	53	
			chsil,gcl,chl				
		32-60	l,sil,chl	ML,CL,SM,SC	0.3	53	
Wurtsboro		0-18	fsl	SM,SC	0.24	42	
			gfsl	SM,SC	0.17	30	
		18-60	fsl(pan)	SM,SC	0.3	53	
			gfsl	SM,SC	0.2	35	

1/ Mapping units may be inserted on the basis of the local county soil survey.

TABLE A1-2b EROSION PROPERTIES OF SOILS IN NEW JERSEY
LAND RESOURCE AREA 148, R=175

<u>Soil Series</u> (Alpha Listing)	<u>Local</u> <u>Mapping</u> <u>No.</u>	<u>1/</u> <u>Typical</u> <u>Profile</u> <u>(Inches)</u>	<u>USDA</u> <u>Texture</u> <u>Range</u>	<u>Unified</u> <u>System</u>	<u>K</u>	<u>KR</u>
Abbottstown		0-20	sil	ML,CL	0.43	75
		20-38	sil(pan)	ML,CL	0.4	70
		38-48	shsil	ML,CL	0.4	70
			shl	SM,GM	0.3	53
Amwell		0-10	sil	ML,CL,SC	0.32	56
			gsil	ML,CL,SC	0.28	49
		10-23	sil,sicl,gsil	ML,CL	0.3	53
		23-41	gsicl,ksicl	ML,CL	0.3	53
			vgsil	GM,GC	-	-
		41-53	kfsl,gsil, vgsil	ML,CL,GC	0.3	53
Annandale		0-10	l	ML,SM	0.28	49
			gl	SM	0.24	42
		10-32	l,cl,scl	ML,CL	0.4	70
			gl,gcl,gscl	ML,CL	0.3	53
		32-44	same as 7-32 inches with pan		0.5	88
		44-60	sl	SM,ML	0.3	53
		gsl	SM,GM	0.2	35	
Athol		0-10	gl	SM	0.32	56
		10-38	sicl,cl	ML,CL	0.3	53
			gcl	SM,SC	0.3	53
		38-60	sicl,cl	ML,CL	0.3	53
			gsl,gcl	SM,SC,GM,GC	0.3	53
Bartley		0-11	l,g	ML,CL	0.32	56
		11-32	cl,l,scl	ML,CL	0.3	53
		32-42	sl,l	SM,SC	0.2	35
		42-60	sl,l,gsl,gcl	SM,SC	0.2	35
Bedington		0-9	shsil	ML,CL	0.32	56
		9-35	shsil,shl	ML,CL	0.2	35
			sil	ML,CL	0.3	53
		35-66	vshl,vshsil	ML	0.2	35
			shsil	CL	0.3	53
		66-72	wesh	GM	0.2	35
Rerks		0-8	shsil,chsil	GM,GC,ML	0.24	42
		8-20	sh to vshsil	SM,GM,GC	0.2	35
		20-30	vshsil	GM,GC,SM	0.2	35
		30+	shattered shale		0.2	35
Birdsboro		0-16	sil,l	ML,CL,SM	0.28	49
		16-48	sicl,cl	CL,ML,SM	0.3	53
		48-60	sl,s,g	GM,GC,SM,GW	0.2	35
			sicl,l	CL,ML	0.3	53
Bowmansville		0-8	sil	ML,CL	0.43	75
		8-32	sil,l,scl	ML,CL	0.4	70
		32-60	sil,scl,sl	ML,CL	0.4	70
			s,g		0.3	53

1/ Mapping units may be inserted on the basis of the local county soil survey.

TABLE A1-2b EROSION PROPERTIES OF SOILS IN NEW JERSEY
LAND RESOURCE AREA 148, R = 175

Soil Series (Alpha Listing)	Local Mapping No.	1/ Typical Profile (Inches)	USDA Texture Range	Unified System	K	KR
Bucks		0-21	sil	ML,CL	0.32	56
		21-36	sicl,sil	ML,CL,MH	0.4	70
		36-52	shsil,vshsil	ML,CL,GM,GC	0.2	35
Califon		0-10	l	ML,SM	0.28	49
			gl,gsil,vstl	SM	0.24	42
		10-32	l,cl,scl	ML,CL	0.4	70
			gl,gcl,gscl	ML,CL	0.3	53
		32-44	same as 10-32 but with pan		0.5	88
	44-60	sl	SM,ML	0.3	53	
		gsl	SM,GM	0.2	35	
Chalfont		0-18	sil	ML,CL	0.43	75
			vstsil	ML,CL	0.37	65
		18-50	sil,sicl	ML,CL	0.6	105
		50-60	shsil,shl	ML,GM	0.6	105
Cokesbury		0-15	l	ML,CL,SM	0.32	56
			gl,vstl,estl	SM,SC	0.24	42
		15-25	cl,sicl	ML,CL	0.4	70
		25-48	l,sl	ML,SM	0.5	88
		48-60	gl	SM,SC	0.4	70
Croton		0-18	sil	ML,CL	0.43	75
			vstsil	ML,CL	0.37	65
		18-36	sil,sicl	ML,CL,CH	0.5	88
		36-48	shsil,shsicl	ML,CL,SMSC	0.4	70
		48+	Shale bedrock			
Doylestown		0-20	sil	ML,CL	0.43	75
		60-48	sil	ML,CL	0.6	105
			shl	GM,GC	0.4	70
Duffield		0-10	sil	ML,CL	0.32	56
			vsil,vrsil	ML,CL	0.28	49
		10-36	sicl	ML,CL,MH,CH	0.3	53
		36-60	sicl	ML,CL	0.4	70
			shsil	ML,CL	0.3	53
Dunellen		0-15	l,sl	ML,SM	0.24	42
			gl,gsl	ML,SM	0.24	42
		15-38	l,sl	ML,SM	0.3	53
			gl,gsl	ML,SM	0.2	35
		38-60	s,gs	SM,SP-SM,GM	0.2	35
Edneyville		0-11	estl,gl,stl,	ML,SM	0.24	42
			vstl			
		11-39	sl,l,scl	ML,SM,SC	0.4	70
			gsl,gl,gscl	ML,SM,SC	0.3	53
	39-65	gsl	SM,GM	0.2	35	
Hazleton		0-9	chl,vstl	SM,GM	0.24	42
		9-40	chl	SM,GM	0.20	35
		40-50	vchl	GM	0.20	35

1/ Mapping units may be inserted on the basis of the local county soil survey.

TABLE A1-2b EROSION PROPERTIES OF SOILS IN NEW JERSEY
LAND RESOURCE AREA 148, R=175

<u>Soil Series</u> (Alpha Listing)	<u>Local Mapping No.</u>	<u>1/</u>	<u>Typical Profile (Inches)</u>	<u>USDA Texture Range</u>	<u>Unified System</u>	<u>K</u>	<u>KR</u>
Klinesville			0-13	shsil,shl,	GM,SM,SC,ML	0.20	35
			13-18	shsil,vshsil			
			18+	vshsil,vshsl	GM,GP	0.2	35
Lamington			0-10	Shale, Bedrock			
			10-23	sil	ML,CL	0.43	75
			23-45	sil,sicl	ML,CL	0.4	70
			45-60	cl,sil,l	ML,CL	0.4	70
Lansdale			0-14	s,sl,sil	SM,SP-SM,ML	0.3	53
				l,sl	SM,SC,ML,CL	0.28	49
				chl,vstl	SM,SC,ML,CL	0.24	42
			14-30	scl,sl	SM,SC	0.3	53
				l	ML,CL	0.4	70
			30-45	chsil,gsl	ML,CL	0.3	53
Lansdowne			45-60	chsl,gsl,fsl	SM,SC	0.2	35
			0-10	l,sil	ML,CL	0.43	75
			10-26	cl,sicl	CL,CH	0.4	70
			26-40	l,sicl	ML,CL	0.4	70
			40-60	shsicl	ML,CL	0.4	70
Lawrenceville			0-28	sil	ML,CL	0.49	86
			28-60	sil	ML,CL	0.6	105
				sl,vfsl	SM,SC	0.6	105
Legore			0-8	gl	SM,GM	0.20	35
			8-24	cl	ML,MH,CL	0.3	53
				gcl,gl,gsicl	SM,SC	0.2	35
			24-66	l,sil,sicl	ML,CL	0.3	53
				gl,vgl,gcl	SM-SC	0.2	35
Lehigh			0-14	sil	ML,CL	0.43	75
				chsil,vstsil	ML,CL	0.37	65
			14-30	chsicl	ML,CL	0.4	70
			30-41	chsicl,vchsil	ML,CL,GM	0.3	53
			41+	Shale Bedrock			
Meckesville			0-10	gl	ML,CL	0.28	49
			10-31	cl,l,scl,	ML,CL,SC	0.4	70
				sicl(g)			
			31-38	l	ML,CL	0.4	70
Mount Lucas			38-60	l,scl,(g,k)	ML,CL,SM,SC	0.3	53
			0-9	sil	ML,CL	0.32	56
				vstsil	ML,CL	0.28	49
			9-32	l,cl,scl,sicl	ML,CL	0.3	53
			32-60	l	ML	0.4	70
Neshaminy				sl	SM-SC	0.3	53
			0-14	sil	ML,CL	0.32	56
				vstsil,gsil	ML,CL	0.28	49
			14-54	sicl,cl	ML,CL	0.3	53
				scl,sl	SM,SC	0.3	53
		54+	Diabase Bedrock				

1/ Mapping units may be inserted on the basis of the local county soil survey.

TABLE A1-2b EROSION PROPERTIES OF SOILS IN NEW JERSEY
LAND RESOURCE AREA 148, R=175

Soil Series (Alpha Listing)	Local Mapping No.	<u>1/</u> Typical Profile (Inches)	USDA Texture Range	Unified System	K	KR
Nixon		0-12	sil,l,sl	ML,CL,SM	0.28	49
		12-45	sil,sicl,cl	ML,CL	0.4	70
		45-60	sl,sil,s	SM,ML	0.3	54
			gsil,gs	SM,ML	0.2	35
Norton		0-14	sil,l	ML	0.32	56
		14-63	sicl	ML,CL	0.4	70
		63-70	sil	ML	0.4	70
			vgl,shl	GM	0.3	53
Parker		0-40	vgl,vgs1,gs1, kl	SM,GM,GP	0.17	30
		40-60	estsp vst1,vst1s, stsl,stls	GM	0.20	35
Parsippany		0-9	l,sicl,sil	ML	0.43	75
		9-50	sicl,cl	ML,CL	0.5	88
		50-60	sicl,cl	ML,CL,CH	0.4	70
Pattenburg		0-7	l,gl,vgl	ML,SM,GM	0.32	56
		7-30	vgl,l,cl,scl	ML,GM,SM,SC	0.3	53
		30-60	gl,vgl,gs1, vgs1	GM,SM	0.2	35
Penn		0-8	l	ML	0.32	56
			shsil	ML,CL	0.28	49
		8-30	sil	ML,CL	0.4	70
		30+	shsil,sicl Shale Bedrock	SC-SM	0.3	53
Pope		0-12	fsl	SM	-	-
		12-46	fsl,l	SM,SC	-	-
		46-60	s,sl,gs,gs1, vgs,vgs1	SP-SM,SM,GP-GM,- GM		
Quakertown		0-16	sil	ML	0.32	56
			chsil	ML	0.28	49
		16-32	sicl	ML,CL	0.3	53
		32-48	chsil,cl	ML,CL	0.3	53
		48+	Sandstone Bedrock			
Karitan		0-14	sil	ML,CL	0.43	75
		14-43	cl,sicl	ML,CL,CH	0.3	53
		43-60	stratified	SM,SC	0.2	35
			s,fsl	SP,SM	0.2	35
			c,sil,l	ML,CL,CH	0.3	53
			g	GM	0.3	53

1/ Mapping units may be inserted on the basis of the local county soil survey

TABLE A1-2b EROSION PROPERTIES OF SOILS IN NEW JERSEY
LAND RESOURCE AREA 148, R=175

<u>Soil Series</u> (Alpha Listing)	<u>Local ^{1/}</u> <u>Mapping</u> <u>No.</u>	<u>Typical</u> <u>Profile</u> <u>(Inches)</u>	<u>USDA</u> <u>Texture</u> <u>Range</u>	<u>Unified</u> <u>System</u>	<u>K</u>	<u>KR</u>
Readington		0-12	sil	ML,CL	0.43	75
		12-40	sil,sicl	SM,SC,ML,CL	0.4	70
		40-50	sil	ML,CL	0.4	70
		50+	v,sh,sil Shale Bedrock	GM	0.3	53
Reaville		0-13	sil	ML,CL	0.43	75
			shsil	ML,CL	0.37	65
		13-23	shsil	ML,CL	0.3	53
		23+	Shale and Silstone Bedrock	GM,GC	0.3	53
Riverhead		0-9	sl	SM,SC	0.28	49
			gsl	SM,SC	0.20	35
		9-34	fsl,slgsl,gfsl	SM,SC	0.3	53
		34-60	ls,s,gl,gs	SP-SM,SM,GP-GM GM	0.2	35
Rowland		0-44	sil,l	ML,CL	0.43	75
			sicl	SM,SC	0.4	70
		44-60	stratified s & g	SM,GM	0.3	53
			sil	SP,GM ML	0.2 0.4	35 70
Tioga		0-9	fsl	ML,CL,SM	0.49	86
		9-24	sil,l,fsl	ML,CL,SM	0.4	70
		24-60	vqls	SM,GM	0.2	35
Turbotville		0-50	l,sil	ML,CL	0.43	75
		50-60	l,sl	ML,SM	0.3	53
Washington		0-9	l,sil	ML,CL	0.32	56
			vstsl	ML,CL	0.28	49
		9-60	l,sicl,cl	ML,CL	0.3	53
Watchung		0-9	sil	ML,CL	0.43	75
		9-46	c,cl,sicl	ML,CL,CH	0.4	70
		46-60	sil,sicl,l	ML,CL	0.4	70
Whippany		0-10	sil	ML,CL	0.43	75
		10-60	sic,c,sicl	ML,CL,CH,MH	0.5	88

^{1/} Mapping units may be inserted on the basis of the local county soil survey.

TABLE A1-2c EROSION PROPERTIES OF SOILS IN NEW JERSEY
LAND RESOURCE AREA 149 R =200

<u>Soil Series</u> (Alpna Listing)	<u>Local</u> <u>Mapping</u> <u>No.</u>	<u>1/</u>	<u>Typical</u> <u>Profile</u> <u>(Inches)</u>	<u>USDA</u> <u>Texture</u> <u>Range</u>	<u>Unified</u> <u>System</u>	<u>K</u>	<u>KR</u>
Adelphia			0-14	sl, fsl, l	ML, CL, SM, SC	0.32	64
			14-37	l, scl, fsl	SM, SC, ML, CL	0.4	80
			37-60	sl, ls	SM	0.2	40
Atsion			0-16	s, fs	SP, SP-SM	0.17	34
			16-60	s, ls	SP, SP-SM	0.2	40
Aura			0-13	sl, l	SM, ML, CL	0.43	86
				gl, gsl	SM, SC	0.32	60
				ls	SP-SM, SM	0.28	40
			13-59	scl	SM, SC	0.4	80
				gscl, gsi	GM, GC	0.3	60
			59-72	scl, sl	SM, SC	0.4	80
				gsl, gcl	SM, SC, GM, GC	0.3	60
	ls	SP-SM	0.2	40			
Barclay			0-14	fsl, lfs	SM	0.49	98
			14-40	vfsl, fsl	SM	0.4	80
			40-60	fs, lfs	SM, SP-SM	0.3	60
Bayboro			0-14	sl, l, sil	ML	0.37	74
			14-64	c, cl, sic	CH, CL, MH	0.2	40
Berryland			0-12	s, fs	SP, SP-SM	0.17	34
			12-72	s, ls, sl	SP, SP-SM	0.2	40
Bertie			0-14	sil, l	ML, CL	0.37	74
			14-40	sil, sicl, l	ML, CL	0.4	80
			40-60	stratified	SM, SC, ML	0.3	60
				sl, l, ls			
				gsl	SM	0.2	40
Bibb			0-28	sl to sicl	ML, CL, SM	0.32	64
			28-60	highly variable	SM, GM, CL	0.20	40
Chillum			0-28	sil	ML, CL	0.32	64
			28-60	gscl, gi	SM, SC	0.3	60
				gsl	GM	0.2	40
Colemantown			0-14	l	ML, CL, SM	0.43	86
			14-30	sc, scl	CL, CH, MI	0.4	80
			30-60	sl, cl, scl	SC, ML, CL	0.4	80
Collington			0-13	sl, fsl	SM, SC, ML	0.28	56
				ls	SM	0.20	40
			13-32	scl, cl, sl, l	SC, SM, ML, CL	0.4	80
			32-60	sl, ls	SM, SC	0.2	40
Colts Neck			0.14	sl	SM	0.28	56
				ls	SM	0.20	40
			14-34	scl, sl, l	SM, SC	0.4	80
			34-60	sl	SM	0.3	60

1/ Mapping units may be inserted on the basis of the local county soil survey.

TABLE A1-2c EROSION PROPERTIES OF SOILS IN NEW JERSEY
LAND RESOURCE AREA 149, R=200

<u>Soil Series</u> (Alpha Listing)	<u>Local</u> <u>Mapping</u> <u>No.</u>	<u>1/</u> <u>Typical</u> <u>Profile</u> <u>(Inches)</u>	<u>USDA</u> <u>Texture</u> <u>Range</u>	<u>Unified</u> <u>System</u>	<u>K</u>	<u>KR</u>
Donlonton		0-12	fsl	ML,CL,SM,SC	0.43	86
		12-40	sc,cl,sic	CH,CL,ML	0.4	80
		40-60	sc,sicl,cl,ls	SM,SC,ML,CL	0.3	60
Downer		0-16	sl	SM,SP-SM	0.28	56
			ls	SM	0.20	40
		16-30	sl	SM	0.3	60
		30-60	s,ls	SP,SP-SM	0.2	40
Dragston		0-14	fsl,sl,lfs	SM,SC,ML	0.28	56
		14-30	sl,scl	SM,SC,CL	0.3	60
		30-60	ls,lfs	SM	0.2	40
Elkton		0-10	sil,sl,l	ML,CL,SM	0.43	86
		10-36	sic,c	CH,CL,MH	0.4	80
		36-60	sic,sicl,scl,c	SC,SM,CL,CH,MH	0.4	80
Evesboro		0-60	ls,s,fs	SM,SP	0.17	34
Fallsington		0-14	sl,fsl,l	SM,SC,ML	0.28	56
		14-35	scl,sl	SM,SC,ML	0.3	60
		35-50	s,ls,sl	SM,SP-SM	0.2	40
Fort Mott		0-24	s,ls	SP-SM,SM	0.20	40
		24-40	sl	SM	0.3	60
		40-60	s	SP-SM,SM	0.2	40
Freehold		0-14	fsl,sl,l	SM,ML	0.28	56
			ls,lfs	SM	0.20	40
		14-32	sl,scl	SM,SC	0.4	80
		32-60	stratified ls,fsl	SM	0.2	40
Freneau		0-60	sl,l	SM,ML	0.28	56
Galestown		0-60	ls,s	SM,SP	0.17	34
Hammonton		0-18	sl	SM	0.28	56
			ls	SP-SM,SM	0.20	40
		18-36	sl	SM	0.3	60
		36-60	s,ls,gs,gl	SP-SM,SM	0.2	40
Holmdel		0-14	fsl,sl,l,lfs	SM,ML	0.28	56
		14-36	sl,scl,l	SM,SC	0.4	80
		36-60	ls,sl	SM	0.2	40
Howell		0-14	fsl,l	SM,ML,CL	0.43	86
		14-35	cl,sicl	CL	0.4	80
		35-60	c,sic,sicl	MH,ML,CL	0.3	60
Keansburg		0-30	sl,fsl,l	SM,ML,SC	0.28	56
		30-60	sl,l	SM	0.3	60

1/ Mapping units may be inserted on the basis of the local county soil survey.

TABLE A1-2c EROSION PROPERTIES OF SOILS IN NEW JERSEY
LAND RESOURCE AREA 149, R=200

<u>Soil Series</u> (Alpha Listing)	<u>Local</u> <u>Mapping</u> <u>No.</u>	<u>1/</u> <u>Typical</u> <u>Profile</u> <u>(Inches)</u>	<u>USDA</u> <u>Texture</u> <u>Range</u>	<u>Unified</u> <u>System</u>	<u>K</u>	<u>KR</u>
Keyport		0-10	sil,l,fsl,sl	SM,ML	0.43	86
		10-44	c,sic,cl	CL,CH,MH	0.4	80
		44-72	sicl,sic	CL,ML,MH	0.4	80
Sandy Substratum		44-72	scl,sl	SM,SC,ML,CL	0.3	60 <u>2/</u>
Klej		0-40	ls,fs	SM,SP-SM,SP	0.17	34
		40-60	ls,fs,lfs,sl	SM,SP-SM,SP	0.2	40
Kresson		0-10	l,sl,ls,fsl	ML,CL,SM,SP-SM	0.43	86
		10-45	sc,scl	ML,MH,CL,CH	0.4	80
		45-60	sl,l	SM,SC,ML,CL	0.3	60
Lakehurst		0-60	s,fs	SP,SP-SM	0.17	34
Lakeland		0-60	ls,lfs,s	SM,SP	0.17	34
Lakewood		0-60	s,fs	SP,SP-SM	0.17	34
Lenoir		0-10	sil,l,fsl	SM,ML	0.43	86
		10-60	sicl,c,sic,cl	CL,CH,ML,MH	0.4	80
Sandy Substratum		40-72	scl,sl	SM,SC,ML,CL	0.3	60 <u>2/</u>
Leon		0-16	s	SP,SP-SM	0.17	34
		16-60	s,ls	SP,SP-SM	0.2	40
Lenoir		0-10	l,sil	ML,CL	0.43	86
		10-40	c,sic,cl	CL,CH,MH	0.4	80
		40-60	cl,sicl	CL,MH,ML	0.4	80
Lincroft		0-60	ls,s	SM,SP-SM	0.17	34
Marlton		0-14	sl,fsl	SM,SC	0.43	86
		14-45	sc,scl	ML,CL,MH,CH	0.4	80
		45-60	sl,scl	SM,SC,CL,ML	0.4	80
Matapeake		0-16	sil,fsl,l	ML-SM,CL	0.32	64
		16-34	sil,sicl	ML,CL	0.4	80
		34-60	s,ls,sl,l gs	SM,SC,CL,ML	0.3	60
Matawan		0-20	sl,ls,fsl	SM,SC	0.32	64
		20-60	cl,scl,sc,sl	CL,SC,SM	0.4	80
Mattapex		0-14	sil,l	ML,CL	0.37	74
		14-40	sicl,sil,cl	ML,CL	0.4	80
		40-60	sl,ls,s,l gs	SM,SC,CL,ML	0.2	40
Matlock		0-10	l	ML,CL	0.43	86
		10-35	sc,scl	ML,CL,MH,CH	0.4	80
		35-60	sl,l	SM,SC,ML	0.3	60

1/ Mapping units may be inserted on the basis of the local county soil survey.
2/ Data for sandy substratum.

TABLE A1-2c EROSION PROPERTIES OF SOILS IN NEW JERSEY
LAND RESOURCE AREA 149, R=200

<u>Soil Series</u> (Alpha Listing)	<u>Local</u> <u>Mapping</u> <u>No.</u>	<u>1/</u> <u>Typical</u> <u>Profile</u> <u>(Inches)</u>	<u>USDA</u> <u>Texture</u> <u>Range</u>	<u>Unified</u> <u>System</u>	<u>K</u>	<u>KR</u>
Monmouth		0-11	fsl,l,lfs	SM,SC,ML,CL	0.43	86
		11-40	sc,scl	CL,SC	0.4	80
		40-60	sl,scl,sc	SM,SC	0.3	60
Nixonton		0-14	fsl,lfs	SM	0.49	98
		14-40	vfsl,fsl	SM	0.4	80
		40-60	lfs,ls	SM,SP-SM	0.2	40
Osier		0-60	s,fs,ls,lfs	SM,SP-SM	0.17	34
Othello		0-14	sil,l,fsl,sicl	ML,CL	0.37	74
		14-34	sicl,sil	ML,CL	0.4	80
		34-60	sl,ls,scl	SM,SC,CL	0.3	60
Pasquotank		0-30	vfsl,fsl	ML,SM	0.49	98
		30-60	vfsl,sl,ls	ML,SM	0.2	40
Pemberton		0-24	s,ls	SM,SP-SM	0.20	40
		24-34	sl	SM,SC	0.2	40
		34-60	s,ls	SM,SP-SM	0.2	40
Plummer		0-46	s,fs,ls,lfs	SM,SP-SM	0.17	34
		46-60	sl,scl	SM,SC	0.30	60
Pocomoke		0-28	sl,l,fsl,ls, lfs	SM,ML	0.28	56
		28-60	ls,s	SM,SP-SM	0.2	40
Portsmouth		0-26	sil	ML,CL	0.28	56
		26-60	fs,cos	SP,SP-SM	0.2	40
Rutlege		0-18	ls,lfs	SM,SP-SM	0.17	34
		18-60	s,fs,ls,lfs	SP-SM,SP,SM	0.2	40
St. Johns		0-12	s	SP,SP-SM	0.17	34
		12-72	s,ls,sl,gs	SP,SP-SM	0.2	40
Sassafras		0.14	fsl,l,sl	SM,ML	0.28	56
			ls,lfs	SM	0.20	40
			gsl	SM,SP	0.24	48
		14-36	scl,sl,l	SM,SC,CL,ML	0.3	60
		36-60	sl,ls,fsl	SM	0.2	40
		gsl,glg	SM,SP,SP-SM	-	-	
Shrewsbury		0-14	sl,fsl,l	SM,ML	0.28	56
		14-30	scl,sl	SC,SM,CL	0.3	60
		30-60	s,ls,sl	SM,SP-SM	0.2	40
Tinton		0-24	s,ls	SM,SP-SM	0.20	40
		24-60	s,ls	SM,SC,SP-SM	0.20	40
Weeksville		0-14	fsl	ML,SM	0.49	98
		14-44	sil,fsl	ML,SM	0.4	80
		44-60	vfsl,fsl,scl	ML,CL,SM	0.4	80

1/ Mapping units may be inserted on the basis of the local county soil survey.

TABLE A1-2c EROSION PROPERTIES OF SOILS IN NEW JERSEY
LAND RESOURCE AREA 149, R=200

<u>Soil Series (Alpha Listing)</u>	<u>Local Mapping No.</u>	<u>1/ Typical Profile (Inches)</u>	<u>USDA Texture Range</u>	<u>Unified System</u>	<u>K</u>	<u>KR</u>
Westphalia		0-14	fsl,lfs	SM,ML	0.49	98
		14-28	fsl,lfs, vfls	SC,SM,ML	0.4	80
		28-60	fs,lfs,fsl	SM,ML,SP-SM	0.3	60
Woodsmansie		0-17	s	SM,SP-SM	0.20	40
		17-30	sl	SM,SC	0.2	40
		30-60	s,ls,sl	SM,SP-SM	0.2	40
Woodstown		0-14	sl,fsl,l ls	SM,SC,ML SM	0.28 0.20	56 40
		14-36	scl,l,sl	SM,CL,SC,ML	0.4	80
		36-60	s,ls,sl	SM,SP-SM	0.2	40
			gsl,gl	SM,SP-SM		

1/ Mapping units may be inserted on the basis of the local county soil survey.

TABLE A1-3

VALUES OF THE TOPOGRAPHIC FACTOR "LS"

Length of Slope (L) ft.	Percent Slope (S)																					
	0.2	0.3	0.4	0.5	1.0	2.0	3.0	4.0	5.0	6.0	8.0	10.0	12.0	14.0	16.0	18.0	20.0	25.0	30.0	40.0	50.0	60.0
20	.05	.05	.06	.06	.08	.12	.18	.21	.24	.30	.44	.61	.81	1.0	1.3	1.6	1.8	2.6	4	6	8	10
40	.06	.07	.07	.08	.10	.15	.22	.28	.34	.43	.63	.87	1.2	1.4	1.8	2.2	2.6	3.5	5	8	11	15
60	.07	.08	.08	.09	.11	.17	.25	.33	.41	.52	.77	1.0	1.4	1.8	2.2	2.6	3.0	4.5	6	10	14	18
80	.08	.08	.09	.09	.12	.19	.27	.37	.45	.60	.89	1.2	1.6	2.1	2.6	3.0	3.6	5.5	7	11	16	21
100	.08	.09	.09	.10	.13	.20	.29	.40	.54	.67	.93	1.4	1.8	2.4	2.9	3.5	4.2	6.0	8	13	18	23
110	.08	.09	.10	.10	.13	.21	.30	.42	.56	.71	1.0	1.5	2.0	2.5	3.0	3.7	4.5	6	9	14	19	25
120	.09	.09	.10	.10	.14	.21	.30	.43	.59	.74	1.0	1.6	2.1	2.6	3.3	4.0	4.6	7	9	14	20	26
130	.09	.09	.10	.11	.14	.22	.31	.44	.61	.77	1.2	1.6	2.2	2.8	3.4	4.1	4.9	7	9	15	20	27
140	.09	.10	.10	.11	.14	.22	.32	.46	.63	.80	1.2	1.7	2.3	2.9	3.6	4.3	5.1	7	10	15	21	29
150	.09	.10	.11	.11	.15	.23	.32	.47	.66	.82	1.2	1.8	2.4	3.0	3.7	4.5	5.3	8	10	16	23	30
160	.09	.10	.11	.11	.15	.23	.33	.48	.68	.85	1.2	1.9	2.5	3.1	3.9	4.7	5.5	8	10	17	24	31
180	.10	.10	.11	.12	.15	.24	.34	.51	.72	.90	1.4	1.9	2.6	3.3	4.1	5.0	6.0	9	12	18	26	33
200	.10	.11	.11	.12	.16	.25	.35	.53	.76	.95	1.4	2.1	2.8	3.6	4.4	5.3	6.3	9	12	18	27	35
300	.11	.12	.13	.14	.18	.28	.40	.62	.93	1.2	1.8	2.7	3.6	4.5	5.6	6.8	8	12	16	25	35	45
400	.12	.13	.14	.15	.20	.31	.44	.70	1.0	1.4	2.0	3.2	4.2	5.4	6.7	8.0	10	14	19	30	42	54
500	.13	.14	.15	.16	.21	.33	.47	.76	1.2	1.6	2.2	3.7	4.9	6.2	7.6	9.2	11	16	21	34	47	61
600	.14	.15	.16	.17	.22	.34	.49	.82	1.4	1.8	2.4	4.1	5.4	6.9	8.5	10.3	12	16	24	38	53	68
700	.15	.16	.17	.18	.23	.36	.52	.87	1.4	1.8	2.6	4.5	5.0	7.5	9.3	11.3	13	18	26	41	58	75
800	.15	.16	.17	.18	.24	.38	.54	.92	1.6	2.0	2.8	4.9	6.4	8.2	10.1	12.2	14	20	28	45	64	81
900	.16	.17	.18	.19	.25	.39	.56	.96	1.6	2.0	3.0	5.2	6.9	9.3	10.8	13.1	16	22	30	48	67	87
1000	.16	.18	.19	.20	.26	.40	.57	1.0	1.6	2.2	3.0	5.6	7.4	9.3	11.6	14.0	17	24	32	51	72	93

When the length of slope exceeds 400 feet and (or) percent of slope exceeds 24 percent, soil loss estimates are speculative as these values are beyond the range of research data.

Table A1-4

C Values and Slope-Length Limits for Various Mulches \1

<u>Type</u>	<u>T/ac</u>	<u>Slope %</u>	<u>C Value</u>	<u>Max Length</u>	
1. No Mulch or Seeding	-	All	1.0	-	
2. Straw or Hay tied	1.0	<5	.20	200	
		6-10	.20	100	
	1.5	<5	.12	300	
		6-10	.12	150	
	2.0	<5	.06	400	
		6-10	.06	200	
		11-15	.07	150	
		16-20	.11	100	
		21-25	.14	75	
		26-33	.17	50	
	3. Crushed Stone (1/4"- 1 1/2")	135	<15	.05	200
			16-20	.05	150
21-33			.05	100	
34-50			.05	75	
240		<20	.02	300	
		21-33	.02	200	
		34-50	.02	150	
4. Woodchips		7	<15	.08	75
			16-20	.08	50
		12	<15	.05	150
	16-20		.05	100	
	21-33		.05	75	
	25	<15	.02	200	
		16-20	.02	150	
		21-33	.02	100	
		34-50	.02	75	

Table A1-4

C Values and Slope-Length Limits for Various Mulches \1

Type	T/ac	C Value	
		Through First 6 Weeks of Growing	After 6 Weeks of Growth
5. Temporary (grain or fast growing grass)	NONE	.70	.10
	Straw 1 T/ac	.20	.07
	Straw 1.5 T/ac	.12	.05
	Straw 2.0 T/ac	.06	.05
6. Permanent Seeding, 2nd Year		-	.01
7. Sod		.01	.01

\1 Based on research data and field experience; prepared at a workshop of personnel from USDA Agriculture Research Service, Soil Conservation Service and various Maryland State and local agencies

TABLE A1-5

PRACTICE FACTOR P_c FOR SURFACE CONDITION FOR CONSTRUCTION SITES

SURFACE CONDITION WITH NO COVER	FACTOR P_c^*
Compact and smooth, scraped with bulldozer or scraper up and down hill	1.3
Same condition, except raked with bulldozer root rake up and down hill	1.2
Compact and smooth, scraped with bulldozer or scraper across the slope	1.2
Same condition, except raked with bulldozer root rake across the slope	0.9
Loose as a disced plow layer	1.0
Rough irregular surface equipment, tracks in all directions	0.9
Loose with rough surface greater than 12" depth	0.8
Loose with smooth surface greater than 12" depth	0.9

*Values based on estimates

TABLE A1-6
ADJUSTMENT FACTOR M FOR ESTIMATING MONTHLY AND PORTIONS OF ANNUAL SOIL LOSS
FOR NEW JERSEY

Starting Months	ENDING MONTHS											
	Jan	Feb	Mar	Apr	May	June	July	Aug	Sept	Oct	Nov	Dec
Jan	0	0.02	0.04	0.06	0.10	0.20	0.35	0.55	0.76	0.86	0.93	0.97
Feb	0.98	0	0.02	0.04	0.08	0.18	0.33	0.53	0.74	0.84	0.91	0.95
Mar	0.96	0.98	0	0.02	0.06	0.16	0.31	0.51	0.72	0.82	0.89	0.93
Apr	0.94	0.96	0.98	0	0.04	0.14	0.29	0.49	0.70	0.80	0.87	0.91
May	0.90	0.92	0.94	0.96	0	0.10	0.25	0.45	0.66	0.76	0.83	0.87
June	0.80	0.82	0.84	0.86	0.90	0	0.15	0.35	0.56	0.66	0.73	0.77
July	0.65	0.67	0.69	0.71	0.75	0.85	0	0.20	0.41	0.51	0.58	0.62
Aug	0.45	0.47	0.49	0.51	0.55	0.65	0.80	0	0.21	0.31	0.38	0.42
Sept	0.24	0.26	0.28	0.30	0.34	0.44	0.59	0.79	0	0.10	0.17	0.21
Oct	0.14	0.16	0.18	0.20	0.24	0.34	0.49	0.69	0.90	0	0.07	0.11
Nov	0.07	0.09	0.11	0.13	0.17	0.27	0.42	0.62	0.83	0.93	0	0.04
Dec	0.03	0.05	0.07	0.09	0.13	0.23	0.38	0.58	0.79	0.89	0.96	0

All dates in the table are as of the 1st of each month, read from left to right.
M=1.0 for one full year.

Example: Given $KR=70$. (LS) = 1.2 What is soil loss for month of July?

$$E_t = 70 \times 1.2 = 84.0 \text{ tons per acre per year.}$$

$$E_t \text{ for July} = 84 \times 0.2 = 17 \text{ tons per acre for July on the average}$$

What is the soil loss if construction begins on the first of May and sod is established on disturbed areas by September 1st?

$$E_t \text{ May to September} = 84 \times 0.66 = 55 \text{ tons per acre.}$$

TABLE A1-7

APPROXIMATE WEIGHTS OF SOILS IN LBS. PER CUBIC FT. AND CONVERSION FACTORS

Soils	Volume Wt. lb./cu. ft.	Conversion Factors		Tons to Cu. Yds.
		Ac. Inches	Ac. Ft.	
Sands and loamy sands	110	0.005	0.00042	0.67
Sandy loam	105	0.0052	0.00044	0.71
Fine sandy loam	100	0.0055	0.00046	0.74
Loam	90	0.0061	0.00051	0.82
Silt loam	85	0.0065	0.00054	0.87
Silty clay loam	80	0.0069	0.00057	0.93
Clay loam	75	0.0073	0.00061	0.99
Silty, sandy clay and clay	70	0.0079	0.00066	1.06
<hr/>				
Aerated Sediment	80*	0.0069	0.00057	0.93
Saturated Sediment	60*	0.0092	0.00077	1.24

*These are the approximate aerated and saturated weights to be used at damage sites. (Streams or reservoirs)

TABLE A1-8

FACTORS FOR MODIFYING THE SOIL LOSS EQUATION TO OBTAIN ESTIMATES BASED ON PROBABILITY AND SINGLE STORM SOIL LOSS

Probability		Single Storm	
One Year In	Factor	Exceeded Once In (Years)	Factor
2	0.9	1	0.2
5	1.25	2	0.3
20	1.70	5	0.4
		10	0.5
		20	0.7

Example: The average annual soil loss from a critical sediment source area was computed to be 100 tons per acre per year.

One year in 5 this loss could be: $100 \times 1.25 = 125$ tons per acre, or one year in 20 the loss could be: $100 \times 1.7 = 170$ tons per acre.

A single storm that may take place once in 10 years could cause a soil loss of $100 \times 0.5 = 50$ tons per acre. If the single storm is one that occurs once in 2 years, the loss might be: $100 \times 0.3 = 30$ tons per acre.

APPENDIX A2

DIVERSION AND GRASSED WATERWAY EXAMPLE DESIGN PROBLEMS AND CHARTS

Diversion Example Problem:

A permanent diversion is to be constructed upslope of a house to divert runoff away from the house, and to protect it from surface water flooding. The diversion will outlet into a grassed waterway. The area upslope of the diversion is in woods which will be preserved. The diversion will be constructed on Rockaway gravelly sandy loam and will be seeded to a lawn grass mixture. It will be a part of the backyard of the house and is expected to be mowed. It will have a grade of 1 percent.

Solution:

The required capacity is the runoff from a 50 year storm. The required freeboard is 0.5 feet from page 2-2-2. Using the procedure in "Urban Hydrology for Small Watersheds, TR55," it was determined that the 50 year peak runoff rate from the watershed draining into the diversion is 20 cfs.

The grass will provide protection of the soil bed, thereby checking the erosion on the diversion. In comparison to a non-vegetated diversion, a grassed diversion will retard the flow of water. Manning's coefficient of roughness for a grassed diversion is related to the retardance. Retardance varies with the product of the mean velocity of flow and the hydraulic radius. The classification for the degree of retardance is based on the type of vegetation and condition of growth.

The maximum permissible velocity from page 2-2-4 for a clay loam soil with vegetation in the channel is 3.0 feet per second. In a back yard, vegetation in the diversion channel can be expected to be maintained.

The appropriate vegetative retardance factors are E & D. The height of the grass will range between 6 inches and less than 2 inches. Select side slopes of 5 to 1 for the channel and ridge so that the diversion can be mowed with a lawn mower. Failure to maintain the grass by periodic maintenance results in weeds and destruction of the grass cover leaving the channel bare in the winter.

During the period of establishing the grass, the diversion will gradually be stabilized under a condition of very low

retardance. The diversion will not reach its maximum capacity until the grass cover is fully developed and well established. Therefore, the hydraulic design of a grassed diversion consists of two stages.

The first stage is to design the cross-section of the diversion for stability under very low retardance (E). Stability of the diversion is based on allowable velocity for the soil type as shown in table 2-2-3.

The second stage is to design the diversion for capacity under a higher retardance (D). The design of the cross-section of the diversion is now based on the capacity of the diversion to take the design flow (Q).

We now have:

Grade of diversion = 1%
Design Capacity (Q) 20 cfs
Maximum allowable velocity = 3.0 fps
Vegetative retardance factors = E and D
Channel side slopes = 5 to 1

First, design for stability using retardance factor E. Enter Figure A2-4 with 3.0 fps and slope = 1.0%, find the maximum allowable R = 0.53.

The cross sectional flow area required is $Q/V = 20/3 = 6.7$ sq. ft.

Enter Figure A2-6 with A = 6.7 and R = 0.53, find bottom width equal 5 feet and depth equal 0.8 feet.

Second, design for capacity using retardance factor D. A trial and error procedure is necessary for a trapezoidal channel with 5:1 side slopes and 20 foot bottom width on a 1% grade with D retardance.

Trial #1

Try d = 1.0 feet, enter figure A2-6

find R = 0.62

A = 9

enter Figure A2-3

find V = 2

$Q = VA = (2) (9) = 18$ cfs

required 20 cfs capacity is larger.

Trial #2

Try d = 1.2 feet, repeat steps in 1st trial

find R = 0.76

A = 13

V = 2.8

Q = 36.4 cfs is larger than required.

Trial #3

Try $d=0.96$ feet,
find $R = 0.64$
 $A = 9.4$
 $V = 2.13$
 $Q = 20$ cfs

Design Flow Dimensions:

- a. Grade = 1%
- b. Side slopes = 5:1
- c. Bottom width = 5 feet
- d. Depth = 1.1 feet (required flow depth)

Constructed Diversion Dimensions:

- a. Grade = 1%
- b. Side slopes of channel is 5:1 both sides, back slope of ridge is 5:1 and, for maintenance reasons, ridge top width is 4 feet from the standard.
- c. Bottom width of the channel is 5 feet
- d. Depth from bottom of the channel to top of ridge is: 0.96 feet for flow depth plus 0.50 feet for freeboard plus 0.1 feet for settlement equals a constructed depth of 1.56 feet.

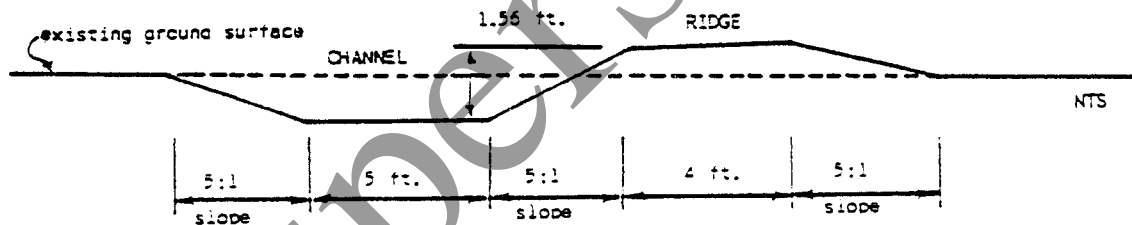

Waterway Example Problem:

A waterway is to be constructed to convey water through an apartment complex. It will be located in an area where the grass will be mowed at least once a year and needed fertilization and repairs will be made on an annual basis. From the soil survey report, the waterway will be constructed on Reaville silt loam. The waterway will have a grade of 0.5%. The peak flow from a 10 year frequency storm is 40 cfs.

Waterway Example Problem Solution:

The maximum permissible velocity from page 2-3-1 for a silt loam with a good stand of vegetation is 2.0 feet per second. The appropriate retardance factors are E and D, since during the year the height of the grass will vary between 2 inches immediately after cutting and 10 inches when it has not been cut. A good stand of vegetation will be maintained by annual fertilization and maintenance. Select a parabolic shape for the waterway to keep low flows from meandering and to provide a shape which is easy to mow and traverse with equipment.

We now have:

Grade of the Waterway = 0.5%
Design Capacity = 40 cfs
Maximum allowable velocity = 2.0 fps
Vegetative Retardance factors = E and D
Channel Shape = parabolic

First, design for stability using the retardance factor E. Enter Figure A2-4 with $V = 2.0$ fps and slope = 0.5%, find maximum allowable $R = 0.57$

The cross sectional flow area required is $Q/V = 40/2 = 20$ sq ft

Enter Figure A2-14 with $A = 20.0$ and $R = 0.57$, find top width (t) = 35.7 feet and depth (d) = 0.84 feet

Second, design for capacity using retardance factor D. A trial and error procedure is necessary for a parabolic channel with the channel shape determined by $d = 0.84$ feet and $t = 35.7$ feet. Enter Figure A2-15 and find a point on the pivot line. This point remains fixed for this channel.

After several iterations:

Try $d = 1.06$ feet for retardance factor D.

From Figure A2-15 using the fixed point on the pivot line for this channel and $d = 1.06$ feet, find $t = 40$ feet. From Figure A2-14 find $R = 0.70$ and $A = 28.2$. Enter Figure A2-3 with $R = 0.70$ and $S = 0.5\%$ and find $V = 1.42$ fps. Then $Q = VA = (1.42)(28.2) = 40$ cfs.

This meets the required Q of 40 cfs, therefore use these dimensions. The design channel dimensions are: Grade = 0.5% and Parabolic shape with a depth (d) = 1.06 feet and top width (t) = 40 feet.

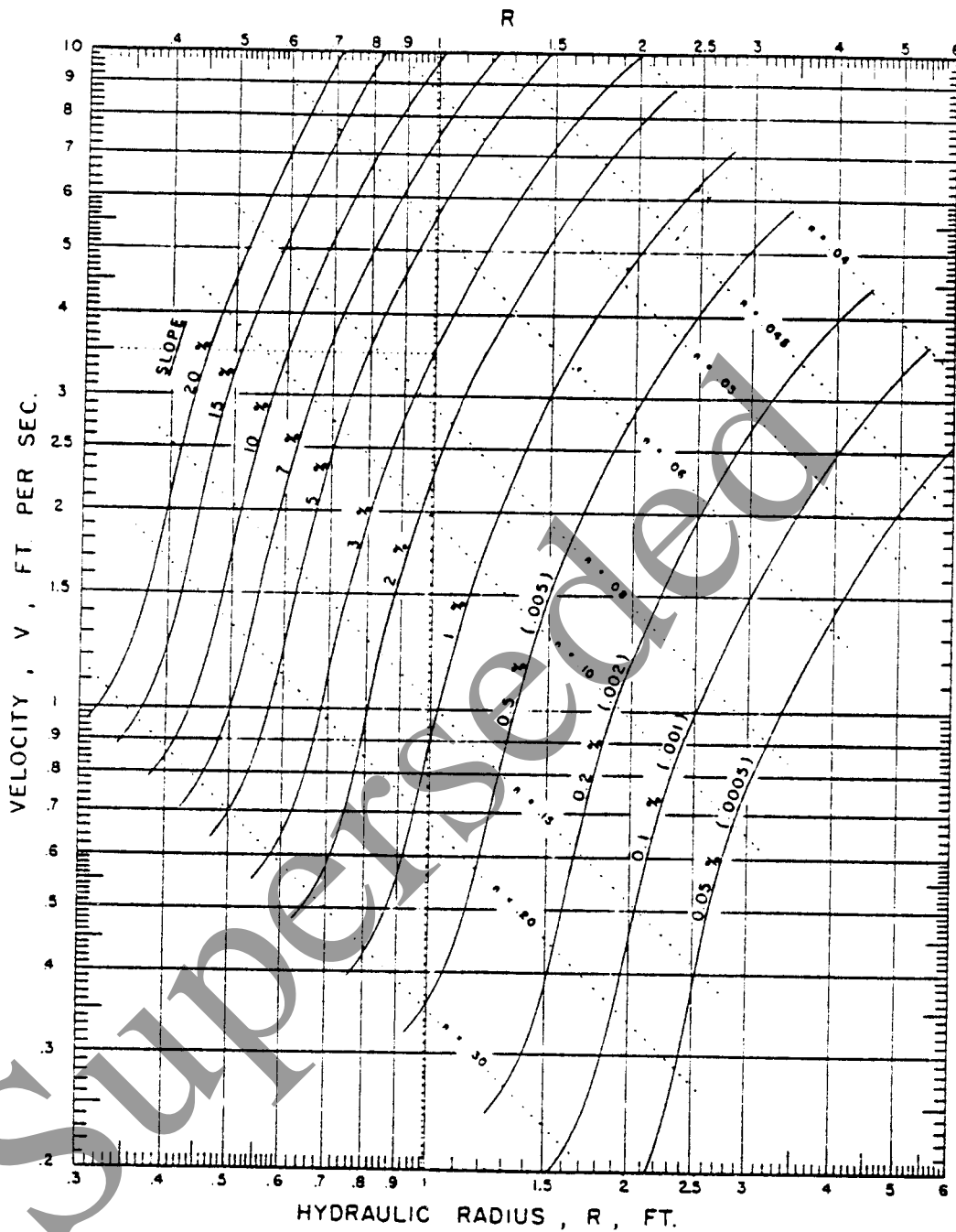

FIGURE A 2-1

SOLUTION OF THE MANNING FORMULA FOR RETARDANCE B (HIGH VEGETAL RETARDANCE)

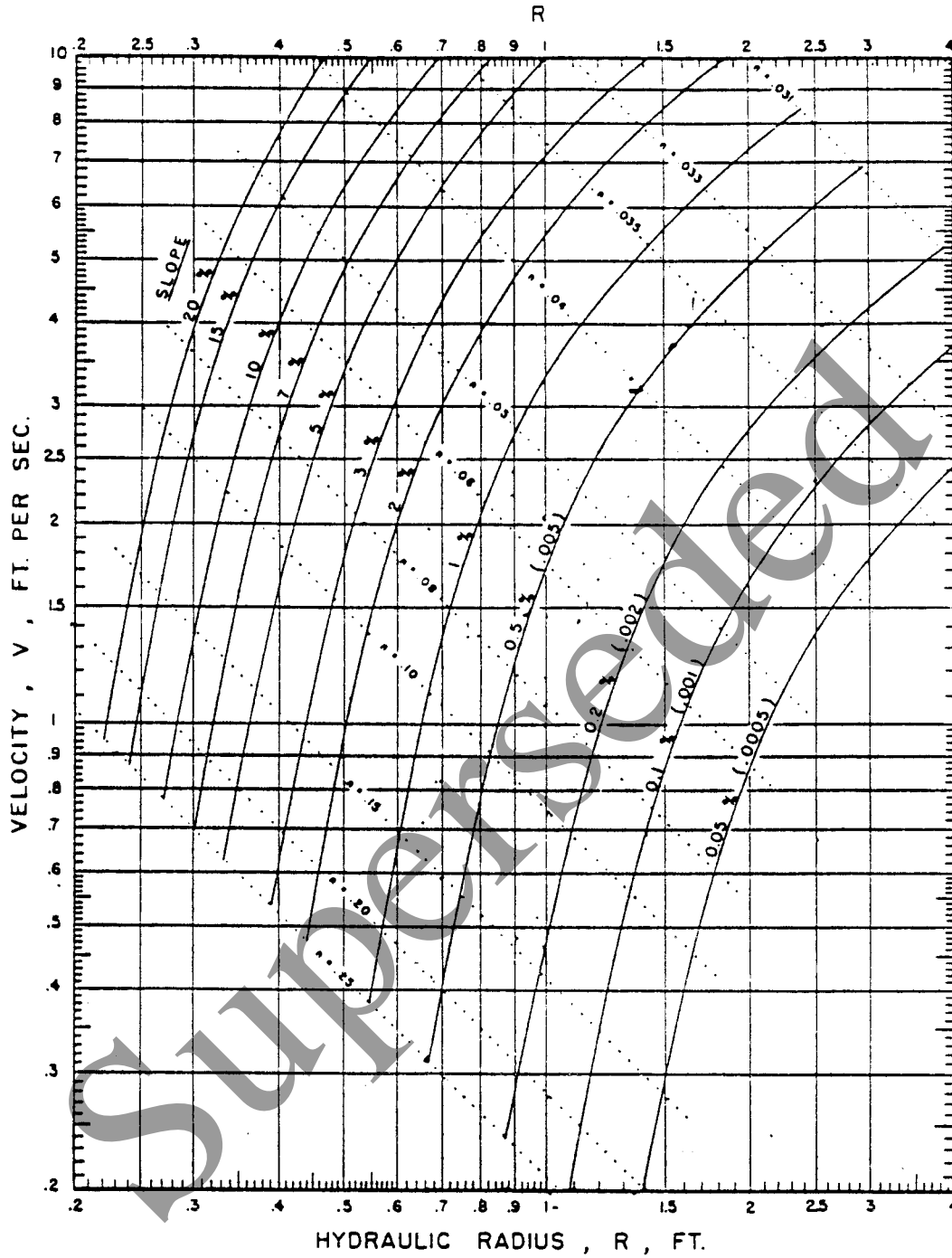

FIGURE A2-2

SOLUTION OF THE MANNING FORMULA FOR RETARDANCE C (MODERATE VEGETAL RETARDANCE)

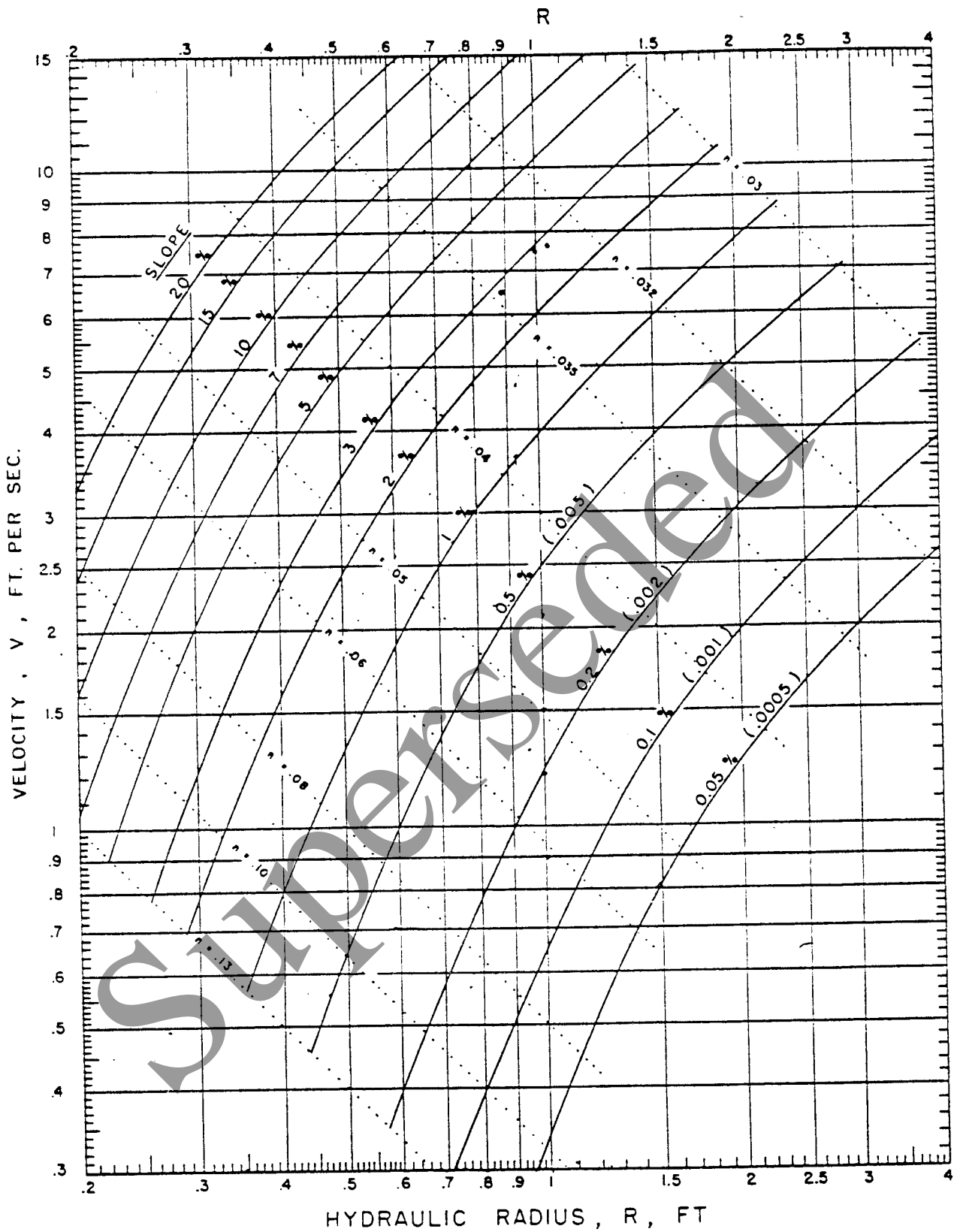

FIGURE A2-3

SOLUTION OF THE MANNING FORMULA FOR RETARDANCE D (LOW VEGETAL RETARDANCE)

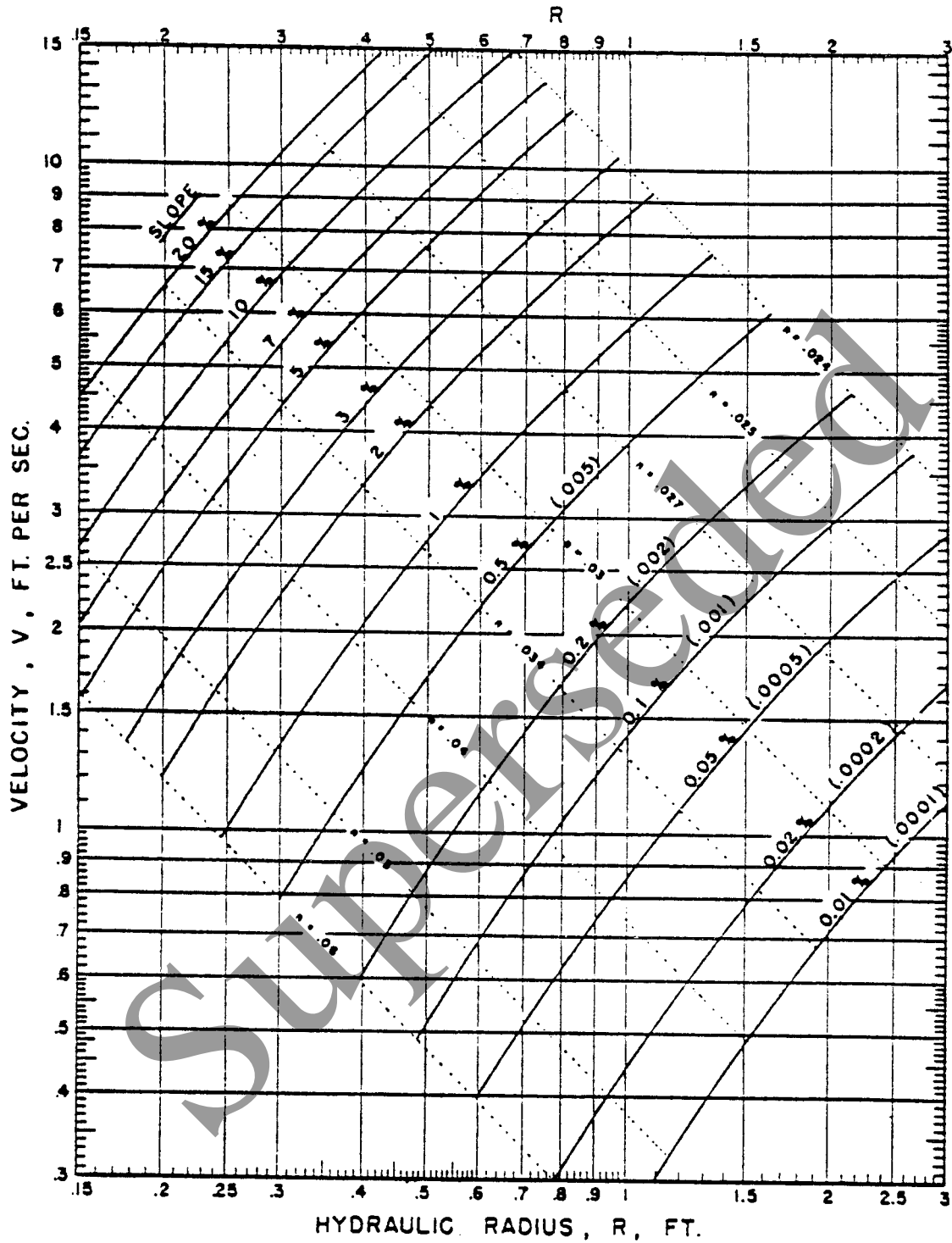

FIGURE A2-4

SOLUTION OF THE MANNING FORMULA FOR RETARDANCE E (VERY LOW VEGETAL RETARDANCE

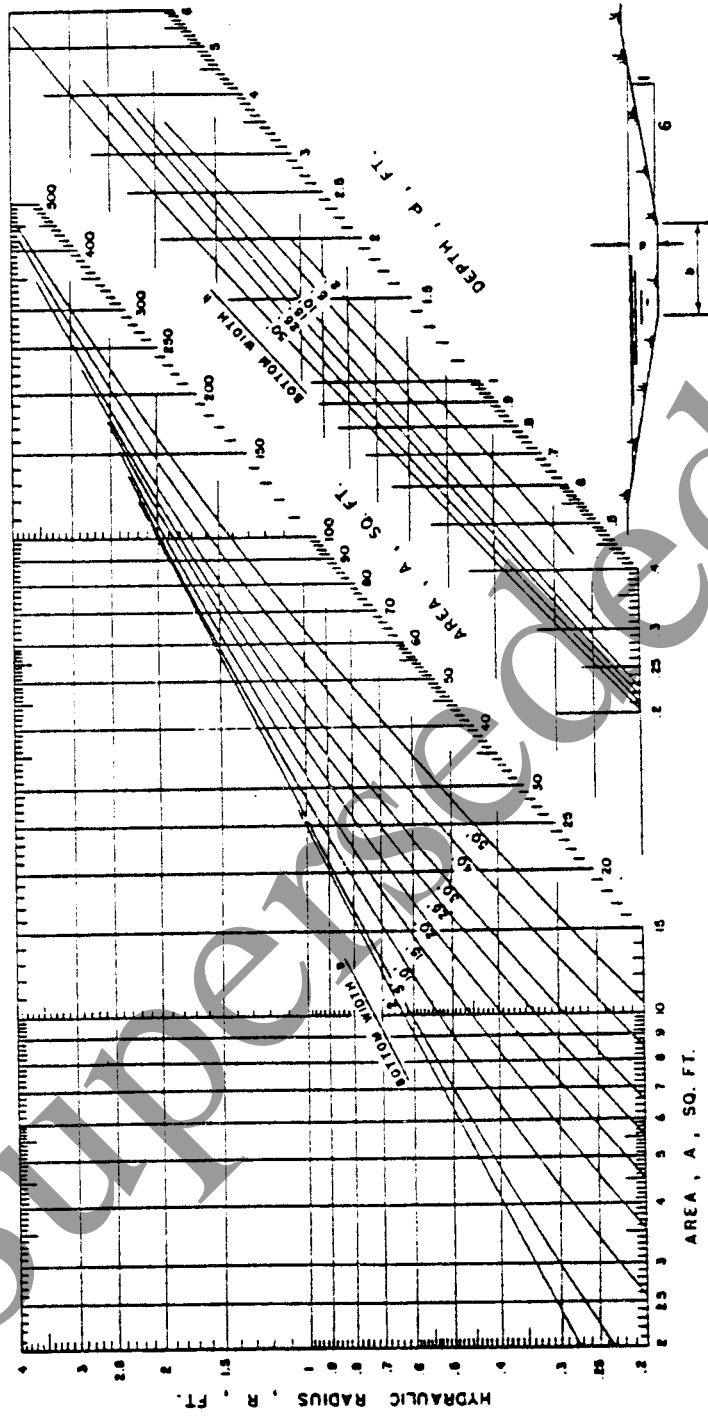

FIGURE A2-5
 DIMENSIONS OF TRAPEZIODAL CHANNELS WITH 6 TO 1 SIDE SLOPES

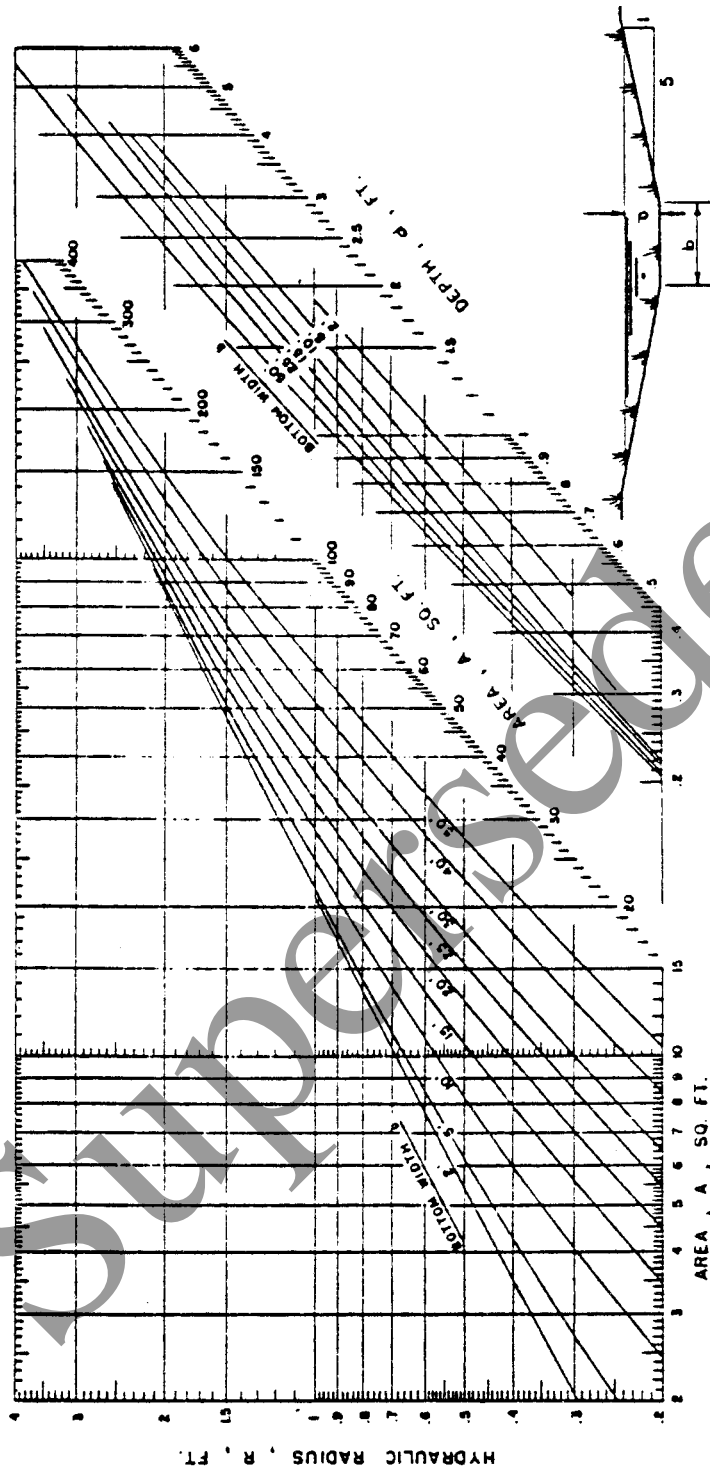

FIGURE A2-6
 DIMENSIONS OF TRAPEZOIDAL CHANNELS WITH 5 TO 1 SIDE SLOPES

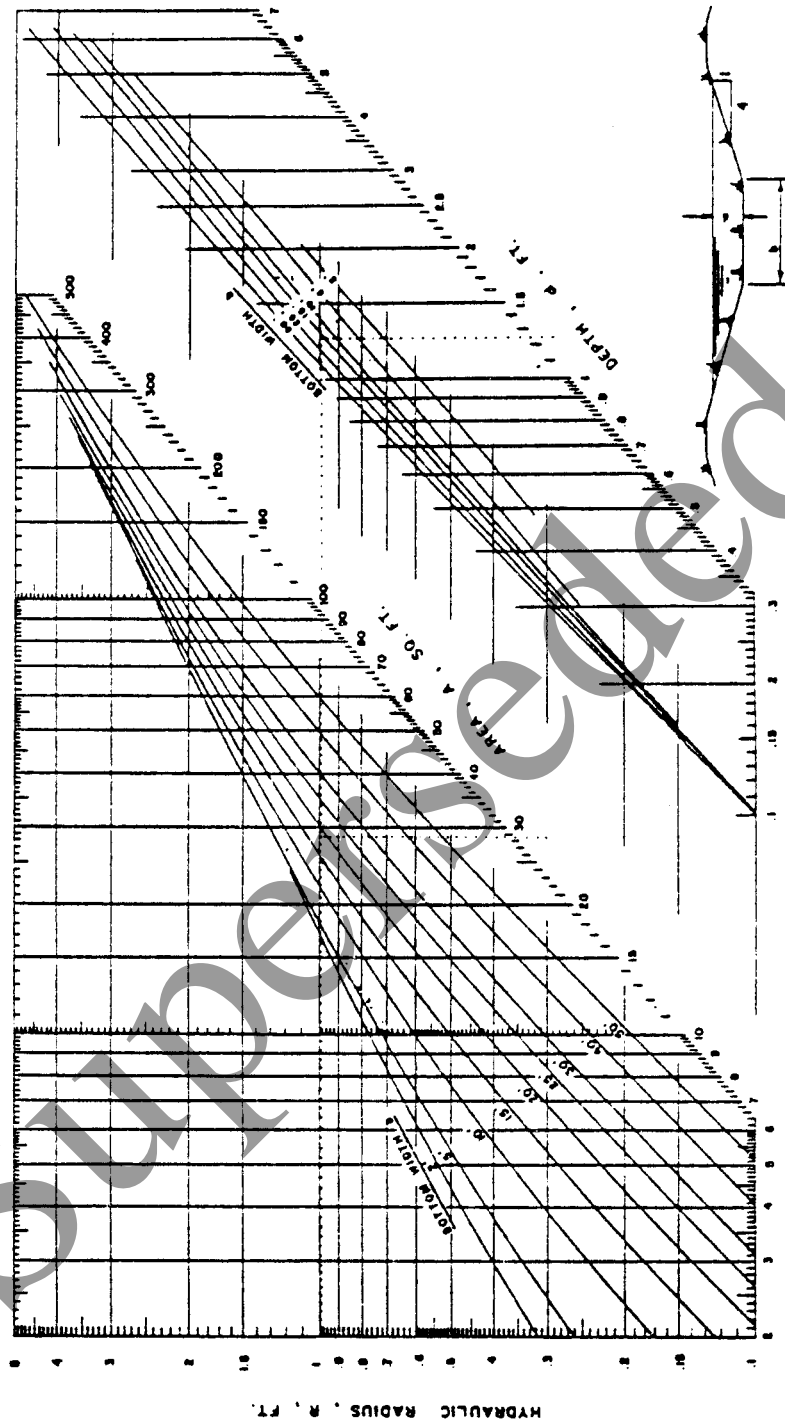

FIGURE A2-7
 DIMENSIONS OF TRAPEZOIDAL CHANNELS WITH 4 TO 1 SIDE SLOPES

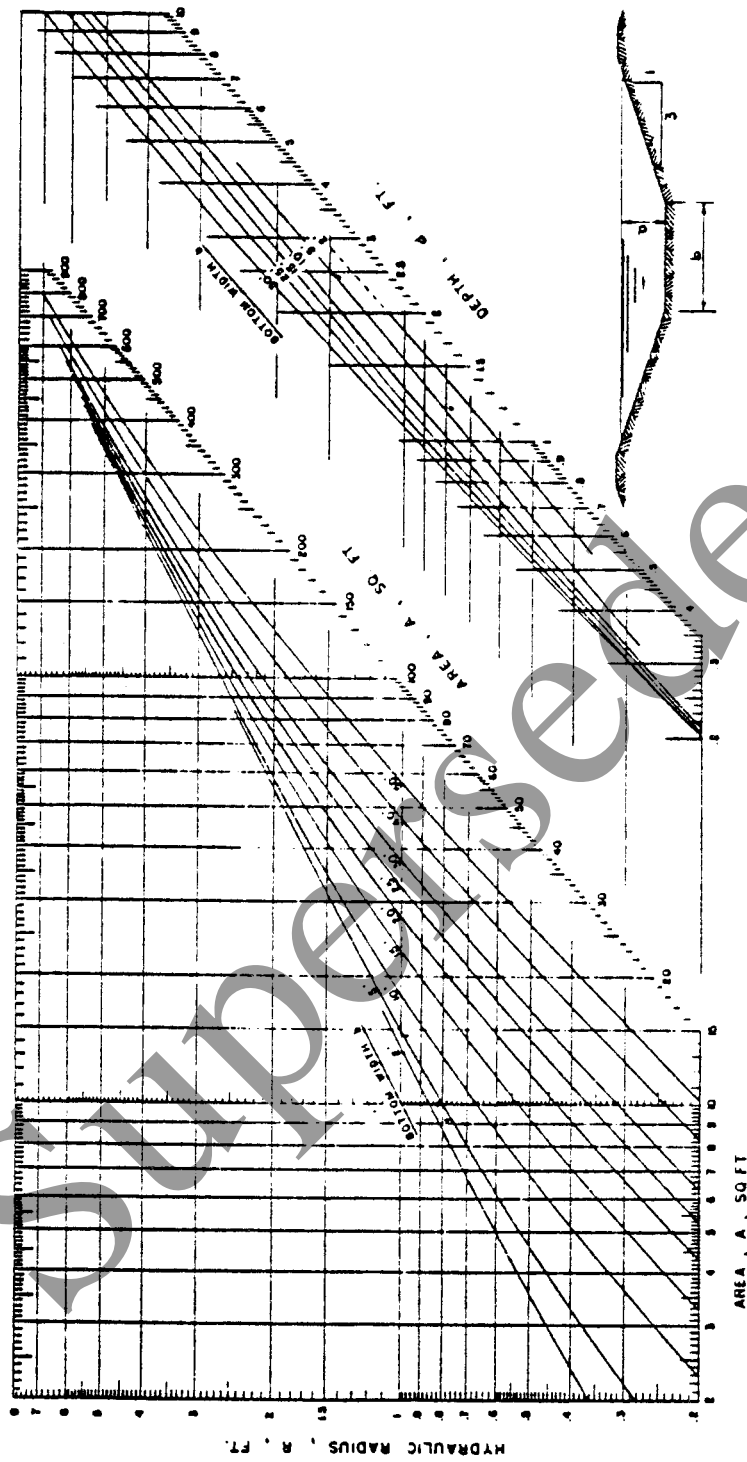

FIGURE A2-8

DIMENSIONS OF TRAPEZOIDAL CHANNELS WITH 3 TO 1 SIDE SLOPES

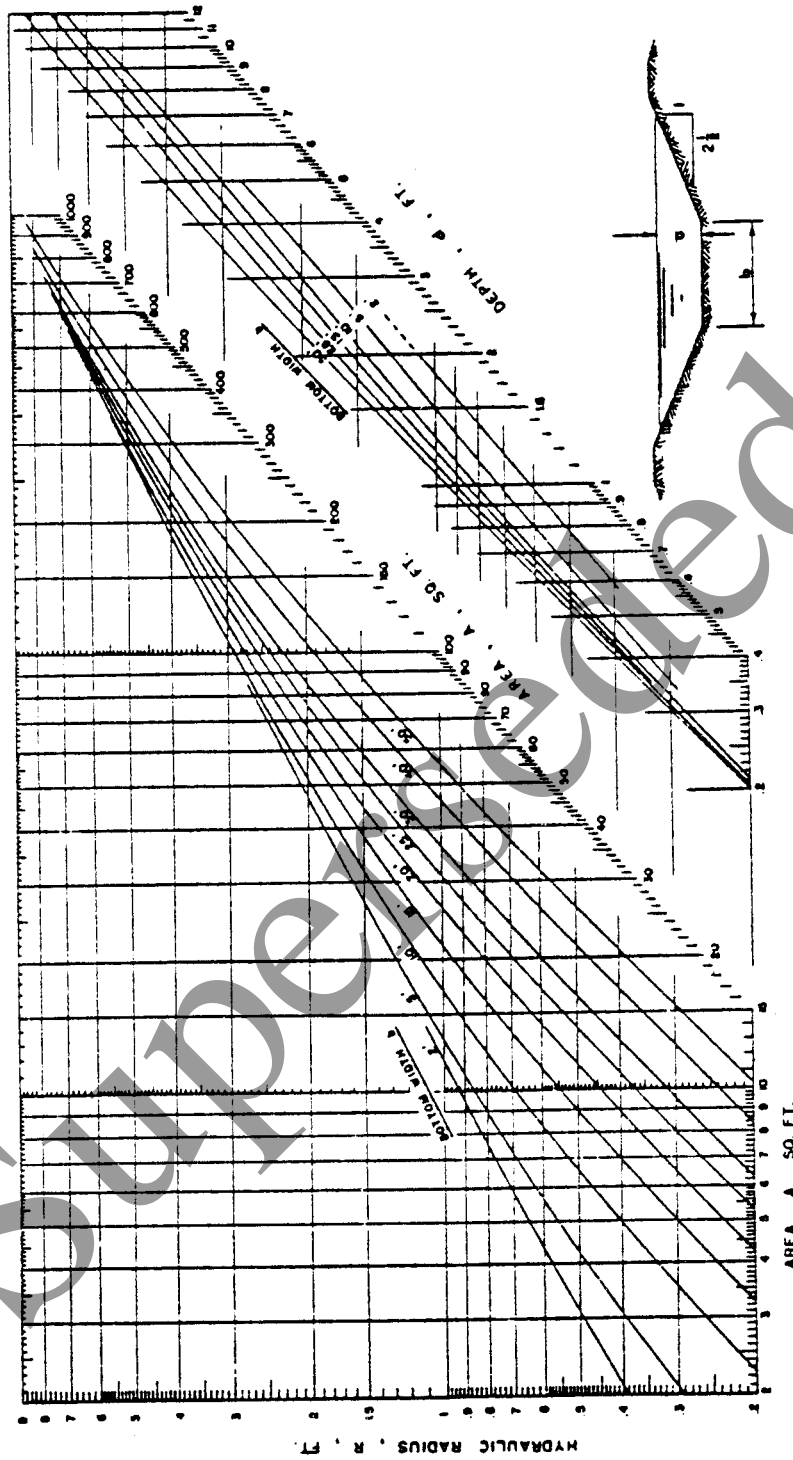

FIGURE A2-9
 DIMENSIONS OF TRAPEZOIDAL CHANNELS WITH 2-1/2 TO 1 SIDE SLOPES

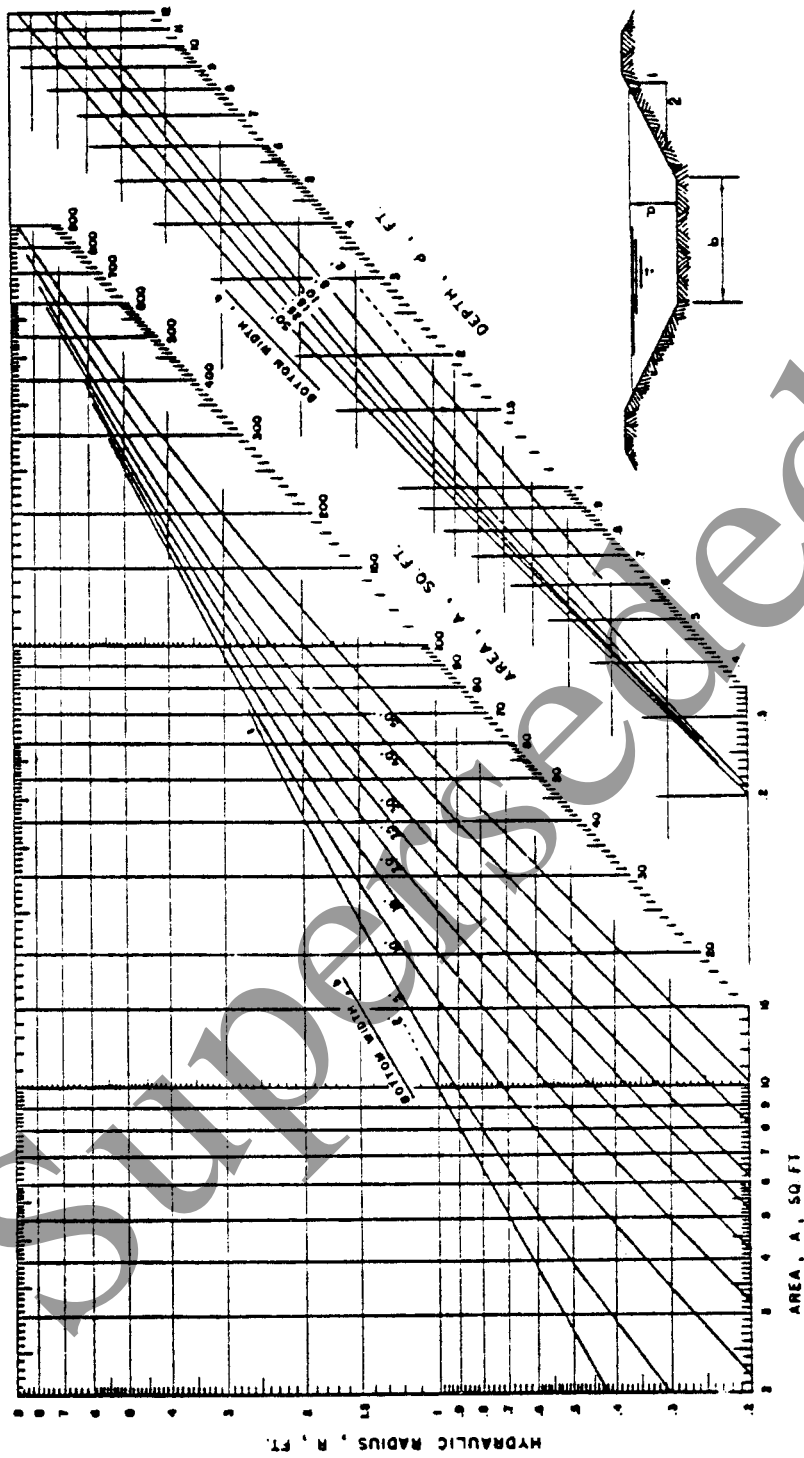

FIGURE A2-10
 DIMENSIONS OF TRAPEZOIDAL CHANNELS WITH 2 TO 1 SIDE SLOPES

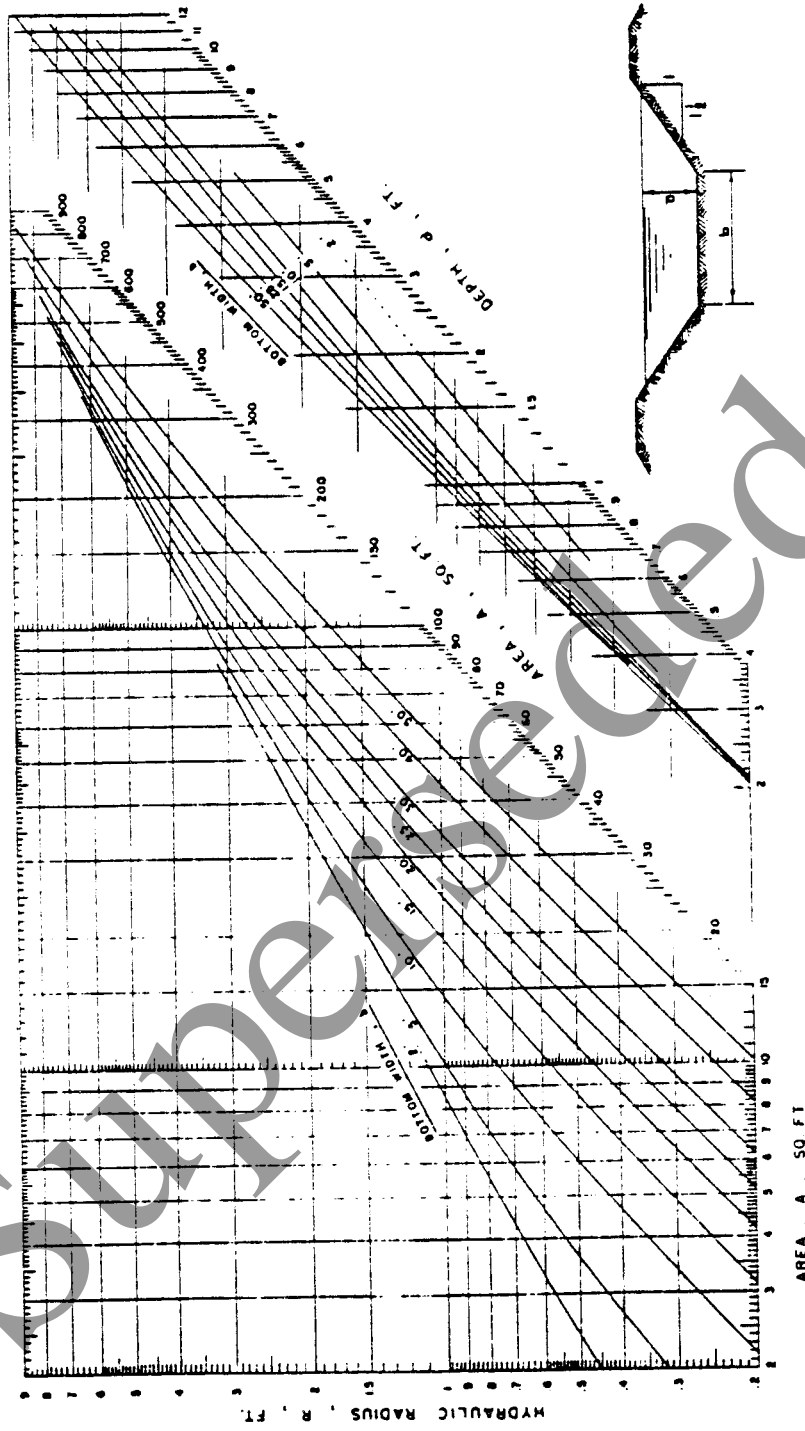

FIGURE A 2-11
 DIMENSIONS OF TRAPEZOIDAL CHANNELS WITH 1-1/2 TO 1 SIDE SLOPES

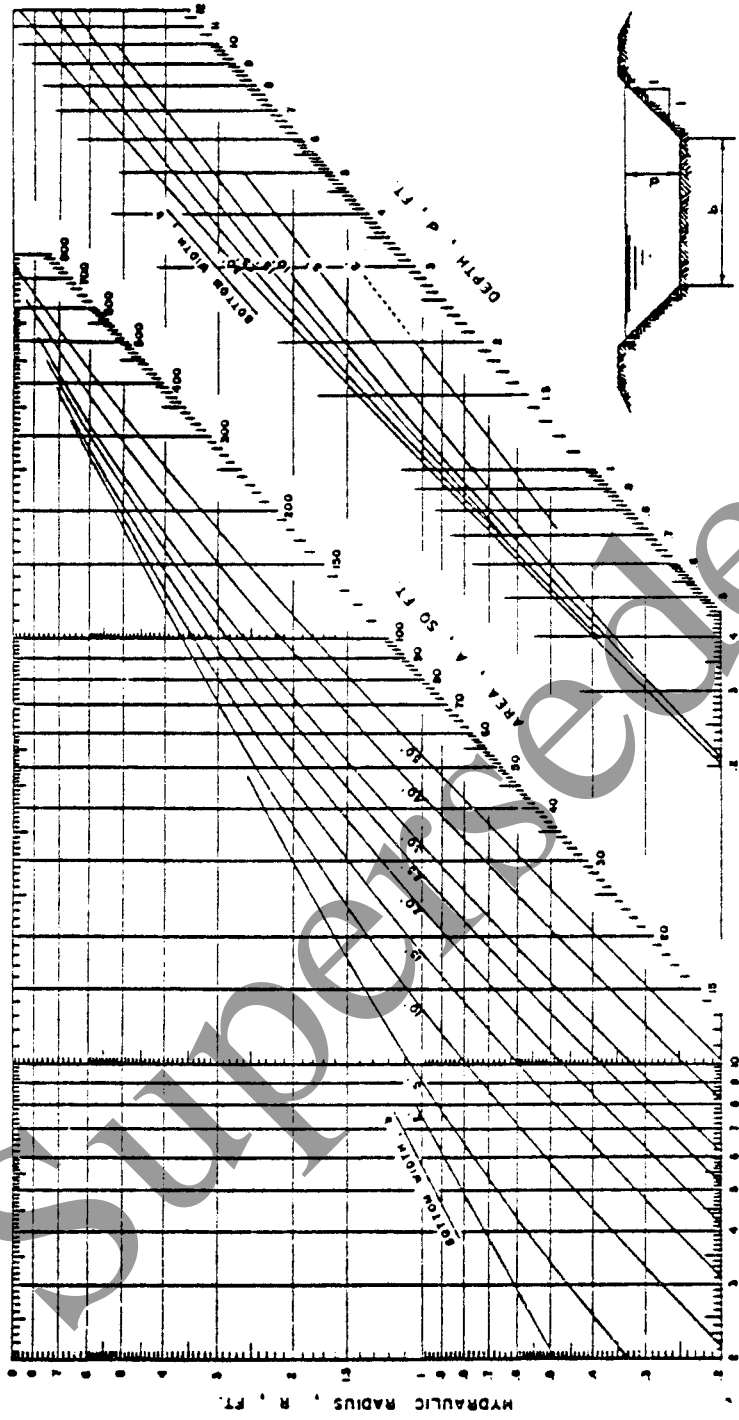

FIGURE A2-12
 DIMENSIONS OF TRAPEZOIDAL CHANNELS WITH 1 TO 1 SIDE SLOPES

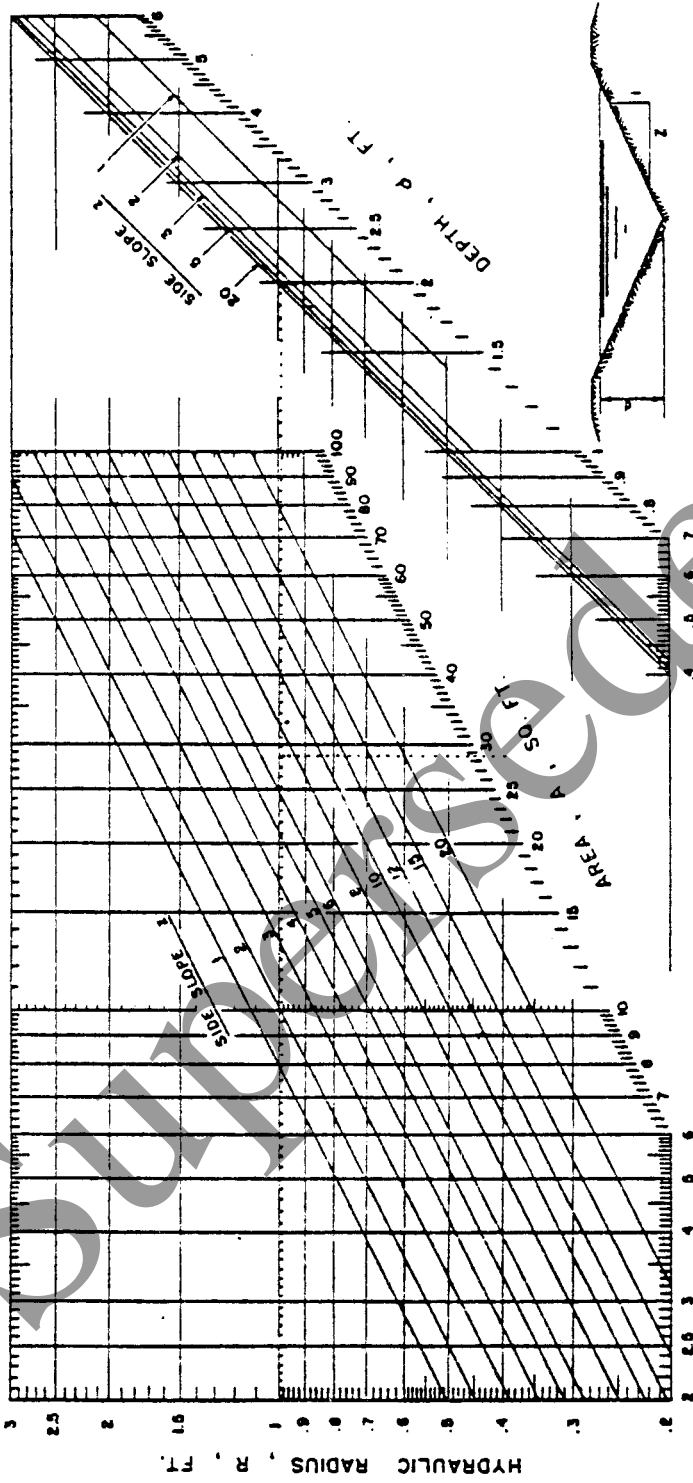
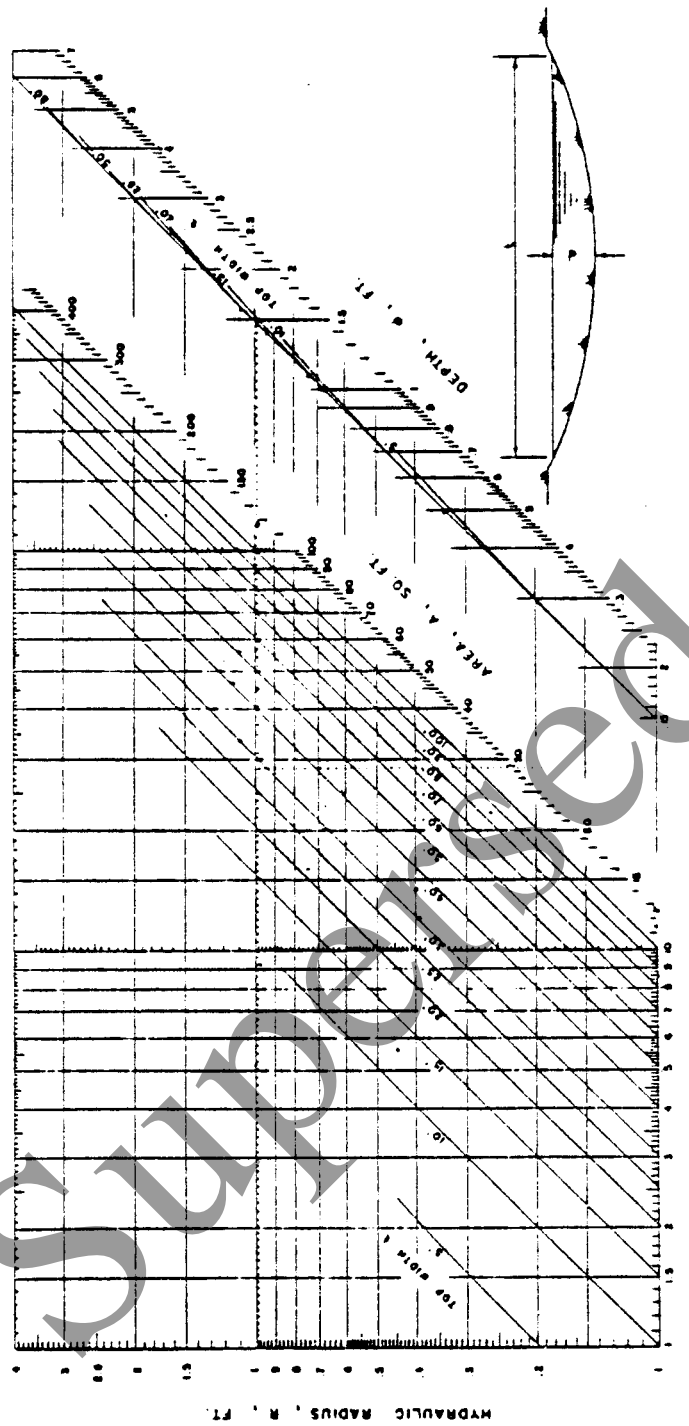

FIGURE A2-13
DIMENSIONS OF TRIANGULAR CHANNELS



NOTE: THIS CHART TO BE USED IN CONJUNCTION WITH THE NOMOGRAPHIC SOLUTION (FIG. A -15)

FIGURE A2 -14
DIMENSIONS OF PARABOLIC CHANNELS

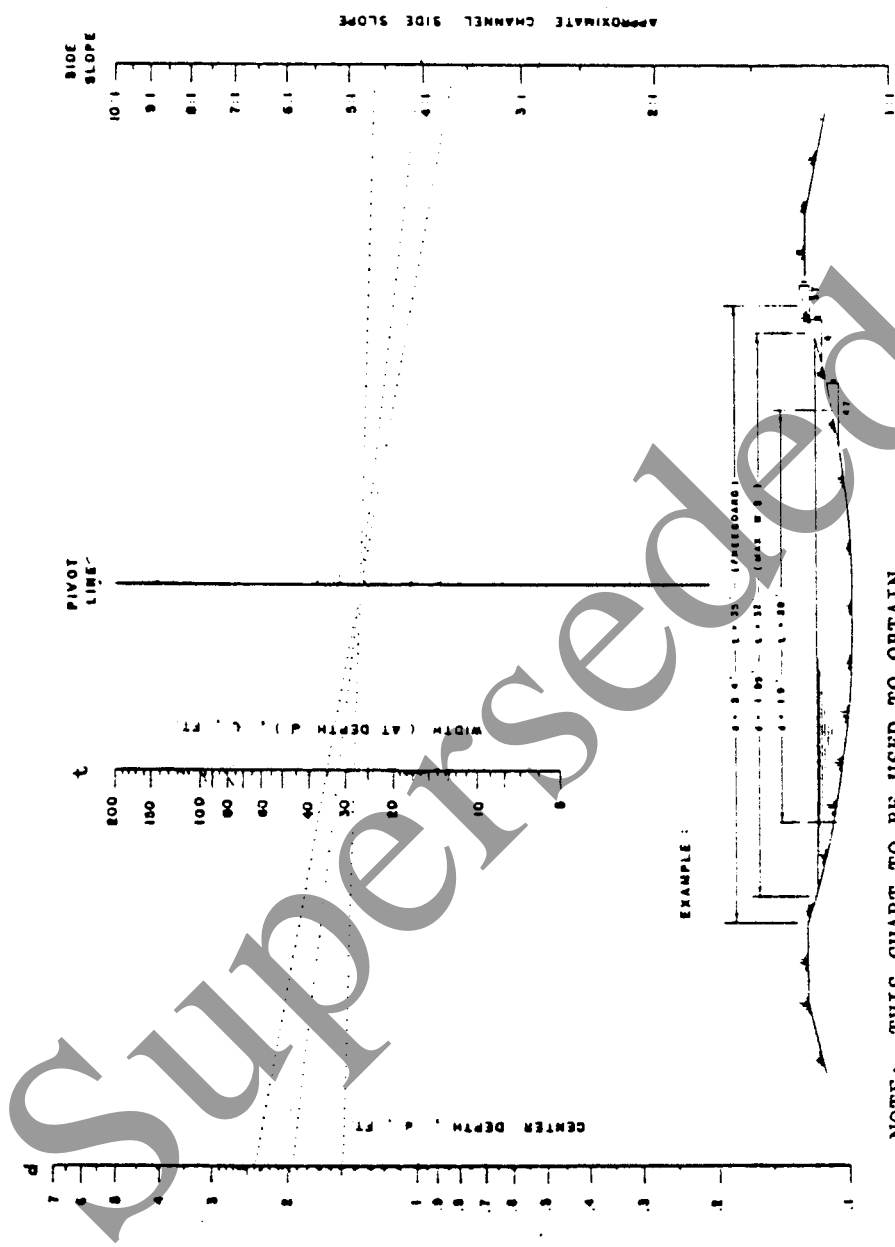

FIGURE A 2-15
SOLUTION FOR DIMENSIONS OF PARABOLIC CHANNELS

Superseded

APPENDIX A3

DETERMINING VOLUME IN A SEDIMENT BASIN TO MEET TRAP EFFICIENCY, SEDIMENT STORAGE AND TEMPORARY FLOODWATER STORAGE REQUIREMENTS

Sample Problem #1

At Toms River in Ocean County, 100 acres drains into a planned sediment basin. Failure of the sediment basin at the planned site will not result in loss of life or damage to buildings, roads, railroads or utilities. 10 acres are to be cleared and developed into houses. 90 acres are in woods and will not be disturbed during the life of the sediment basin. It is estimated it will take 18 months to develop the site. The sediment basin will be installed as the first item of construction and removed as the last item of construction. The owner estimates that the 10 acres to be developed will be bare for 12 months and under roofs, pavement, and sod for the last 6 months of construction. The soils are Woodmansie sand. The sediment pool will be normally dry.

- I. Determine minimum basin volume to meet the 70% trap efficiency requirement. Set trap efficiency at 75% to meet actual trap efficiency requirement of 70% for a dry sediment pool with coarse sediment, as required by the standard in the section on Trap Efficiency.

Enter Curve 2.4-1 with 75%. Find $C/I = 0.025$ using curve for coarse grained sediments. From Figure 2.4-1, average annual surface runoff for Toms River is 25 inches; $I = (25 \text{ in}) (1 \text{ ft}/12 \text{ in}) (100 \text{ ac})$
 $I = 208.3 \text{ Ac ft}$

$C = (208.3 \text{ ac. ft.}) (0.025)$

$C = 5.21 \text{ ac. ft.} =$ minimum volume in the sediment basin below emergency spillway elevation to obtain 70% trap efficiency with a dry pool.

- II. Determine minimum basin volume to meet the requirements for sediment storage and temporary floodwater storage.
 1. Determine volume for sediment storage using Method 2 in the standard under Sediment Storage Capacity.
 - a. Determine, DA and A, Drainage Area and Average Annual Erosion
1st year

Woods
 $(DA) (A) = 90 \text{ ac} \times 0.2 \text{ tons/ac/yr} = 18 \text{ tons/yr}$
Construction Area
 $(DA) (A) = 10 \text{ ac} \times 60 \text{ tons} = 600 \text{ tons/yr}$
 $(DA) (A) = 618 \text{ tons for the 1st year.}$

2nd year

Woods (DA) (A) = 90 ac x 0.2 tons/ac/yr = 18 tons/yr
Urban Area

(DA) (A) = 10 ac x 1.0 tons/ac/yr = 10 tons/yr

(DA) (A) = (18 + 10) (1/2) = 14 tons for 2nd year
for six month life.

(DA) (A) = 618 + 14 = 632 tons for the life of the basin.

- b. Determine DR, delivery ratio

$100/640 = 0.16$ sq mi from Figure 2.4-2 for a sandy soil,
DR = 24%

- c. Determine γ , density of the sediment. From Tabel 2.4-2 the density of aerated sand is 85-100 lbs/ cu ft., Use $\gamma = 90$ lbs/cu ft.

- d. Determine minimum volume for sediment storage for the planned life of the structure.

$V = (DA) (A) (DR) (TE) (1/\gamma) (2,000 \text{ lbs/ton})$
(1/43,560 sq. ft./ac.)

$V = (632) (0.24) (0.70) (1/90) (2,000) (1/43,560)$

$V = 0.054$ Ac. ft.

2. Determine minimum volume for temporary floodwater storage.

- a. The standard requires that we have at least 1 foot between the crest of the principal spillway and the crest of the emergency spillway and that the runoff from the 2 year frequency 24 hour duration storm not cause flow in the emergency spillway. See the sections in the standard on Sediment Basin Volume and Principal Spillway.

- b. The 2 year 24 hour rainfall is 3.5 inches and the hydrologic soil group for Woodmansie sand is B from reference #1.

- c. From reference #9, Urban Hyrdology for Small Watersheds, the runoff curve number is 58. The runoff is 0.45 watershed inches from a 2 yr 24 hr storm.

- d. The size of principal spillway pipe selected will have an effect on the volume of temporary floodwater storage required. For this site we selected a 18" CMP riser with a 12" CMP outlet. From the site survey and the preliminary layout of the principal spillway we found that the capacity of the spillway is approximately 5 cfs.

- e. Using the above principal spillway and the approximate flood routing methods in reference 1, we find that 0.2 watershed inches is required for temporary floodwater storage for the 2 yr 24 hr storm.

f. The minimum volume for temporary floodwater storage using the 12 inch CMP principal spillway is 0.2 watershed inches or converting to ac.ft. is 1.67 ac.ft.

3. The minimum basin volume to meet the requirement for sediment storage capacity and temporary floodwater storage is 0.054 ac.ft + 1.67 ac.ft = 1.72 ac. ft.

III. The standard under Sediment Basin Volume requires that we provide volume for the larger of the two values calculated above under I and II.

The volume for 70% trap efficiency is 5.21 ac. ft. The volume for sediment and temporary floodwater storage is 1.72 ac. ft. Therefore, we must provide below the crest of the emergency spillway at least 5.21 ac. ft. of volume.

Sample Problem #2

Same as sample problem #1, except location is Morristown and the soils are Parsippany silt loam.

- I. Determine minimum basin volume to meet the 70% trap efficiency requirement. Set trap efficiency at 80% to meet actual trap efficiency requirement of 70% for a dry sediment pool with fine sediment. From Curve 2.4-1, using curve for fine grained sediment, $C/I = 0.12$. From Figure 2.4-1, $I = 23\text{-}1/2$ inches for Morristown.
 $I = (23\text{-}1/2 \text{ in}) (1 \text{ ft}/12 \text{ in.}) (100 \text{ ac}) = 196 \text{ ac. ft.}$
 $C = 23.5 \text{ ac. ft.} = \text{minimum volume for 70\% trap efficiency.}$
- II. Determine minimum basin volume to meet the requirements for sediment storage and temporary flood water storage.
 1. Determine volume for sediment storage using Method 2 in the standard under Sediment Storage Capacity.
 - a. (DA) (A) same as in Sample Problem #1
(DA) (A) = 618 tons for the 1st year
(DA) (A) = 14 tons for the 2nd year
 - b. Determine, DR, delivery ratio.
The Parsippany soil is described in the soil survey report as a silt loam, clay loam or silty clay loam at different depths. Therefore, in Figure 2.4-2, use the curve for silty clay with 0.16 sq. mi. drainage area, DR = 72%.
 - c. Determine, γ , density of sediment. $\gamma = 80 \text{ lbs/cu ft}$, using Table 2.4-2 with clay-silt mixture with more silt than clay.
 - d. Determine minimum volume for sediment storage for the planned life of the structure.

$$V = (DA) (A) (DR) (TE) (1/\gamma) (2,000 \text{ lbs./ton})$$

$$(1/43,560 \text{ sq. ft./Ac.})$$

$$V = (618 + 14) (0.72) (0.70) (1/80) (2,000) (1/43,560)$$

$$V = 0.18 \text{ ac ft}$$

2. Determine minimum volume for temporary floodwater storage.

- a. The standard requires that we have at least 1 foot between the crest of the principal spillway and the crest of the emergency spillway and that the runoff from the 2 year frequency 24 hour duration storm not cause flow in the emergency spillway. See the sections in the standard on Sediment Basin Volume and Principal Spillway.
- b. The 2 year 24 hour rainfall is 3.3 inches and the hydrologic soil group for Parsippany silt loam is D, from reference #1.
- c. From reference #9, Urban Hydrology for Small Watershed, the runoff is 1.42 watershed inches from a 2 yr 24 hr storm.
- d. The size of principal spillway pipe selected will have an effect on the volume of temporary floodwater storage required. For this site we selected a 18" cmp riser with a 12" cmp outlet. From the site survey and the preliminary layout of the principal spillway we found that the capacity of this spillway is approximately 5 cfs.
- e. Using the above principal spillway and the approximate flood routing methods in reference 1, we find that 0.9 watershed inches is required for temporary floodwater storage for the 2 yr 24 hr storm.
- f. The minimum volume for temporary floodwater storage using the 12 inch cmp principal spillway is 0.9 watershed inches or converting to ac. ft. is 7.5 ac. ft.

3. The minimum basin volume to meet the requirement for sediment storage capacity and temporary floodwater storage is 0.18 ac. ft. + 7.5 ac. ft. = 7.68 ac. ft.

III. The standard under Sediment Basin Volume requires that we provide volume for the larger of the two values calculated above under I and II.

The volume for 70% trap efficiency is 23.5 ac. ft. The volume for sediment and temporary floodwater storage is 7.68 ac. ft. Therefore, we must provide below the crest of the emergency spillway at least 23.5 ac. ft. of volume.

Conclusions From Sample Problems

To have a reasonably sized sediment basin that is effective, two factors are critical. The total drainage area must be small and the sediment must be coarse textured, or the basin becomes excessively large.

The effect of sediment size is shown by the difference in basin size from sample problem #1 to #2. When changing from a sand typical of South Jersey to a silt-clay typical of North Jersey, the minimum basin volume goes from 5.21 ac. ft. to 23.5 ac. ft.

If the soils were silt and clay and the basin was located so that the only drainage area was the 10 disturbed acres, the minimum basin volume would be 2.3 ac. ft. With sand sediments and a 10 ac. drainage area, the minimum basin volume would be 0.5 ac. ft.

Superseded

METHODS OF DEWATERING SEDIMENT BASINS

The dewatering methods shown here are inexpensive and operate automatically.

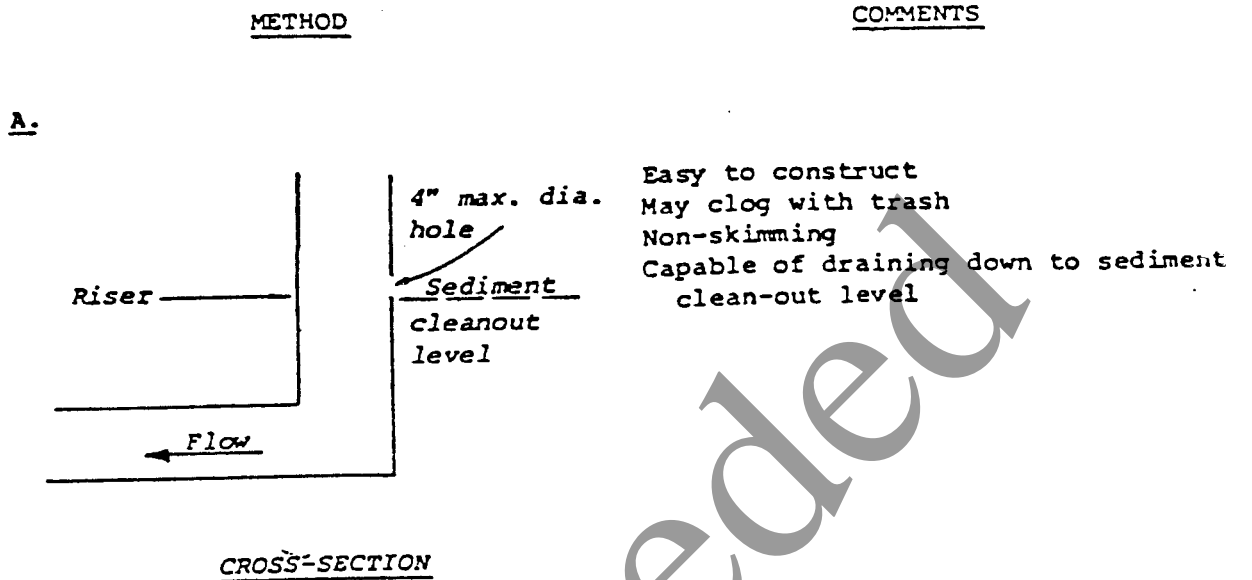

B. Same as "A" except for skimming device, detailed below:

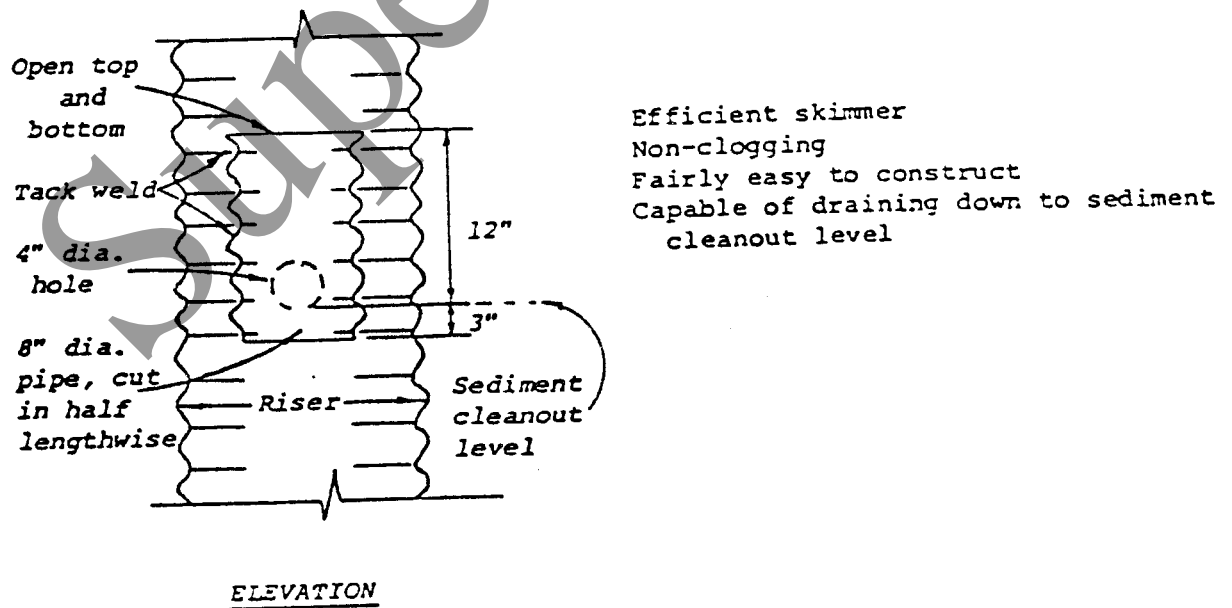

METHOD

COMMENTS

C.

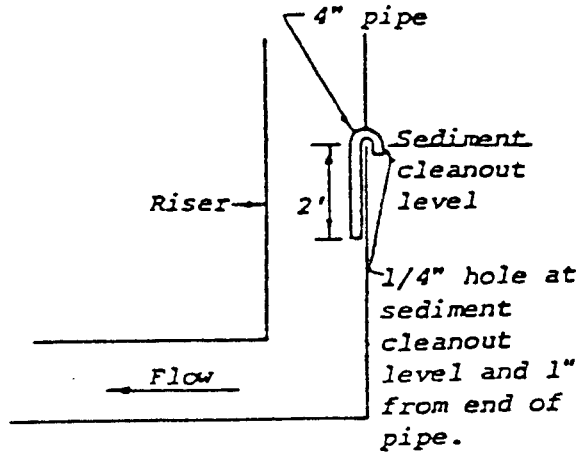

CROSS-SECTION

Efficient skimmer
Capable of always draining down to sediment cleanout level and below
Higher discharge rate than "A" or "B".

D.

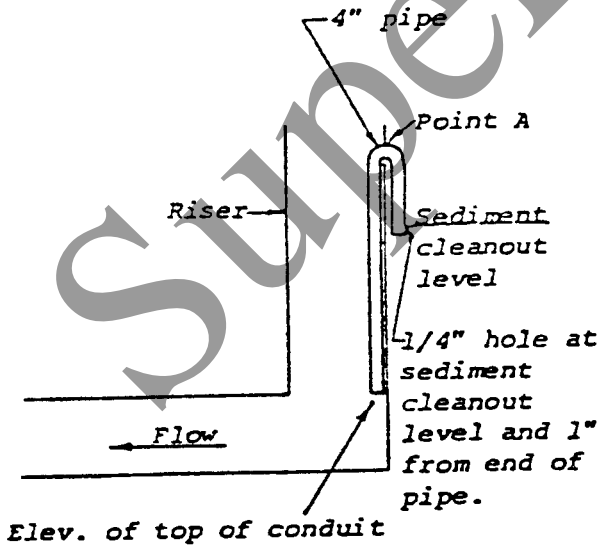

CROSS-SECTION

Efficient skimmer
Water must inundate point A to prime siphon. Therefore, small storms will not prime siphon and drain pool down to sediment cleanout level.

Higher discharge rate than "C"

DEWATERING SEDIMENT BASIN WITH SUBSURFACE DRAIN

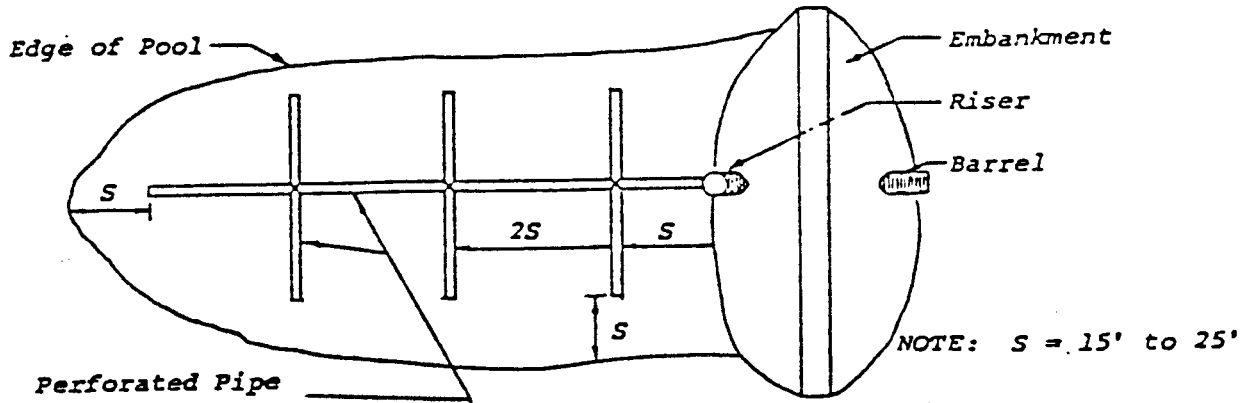

Perforated Pipe
in Trench

PLAN VIEW



PROFILE

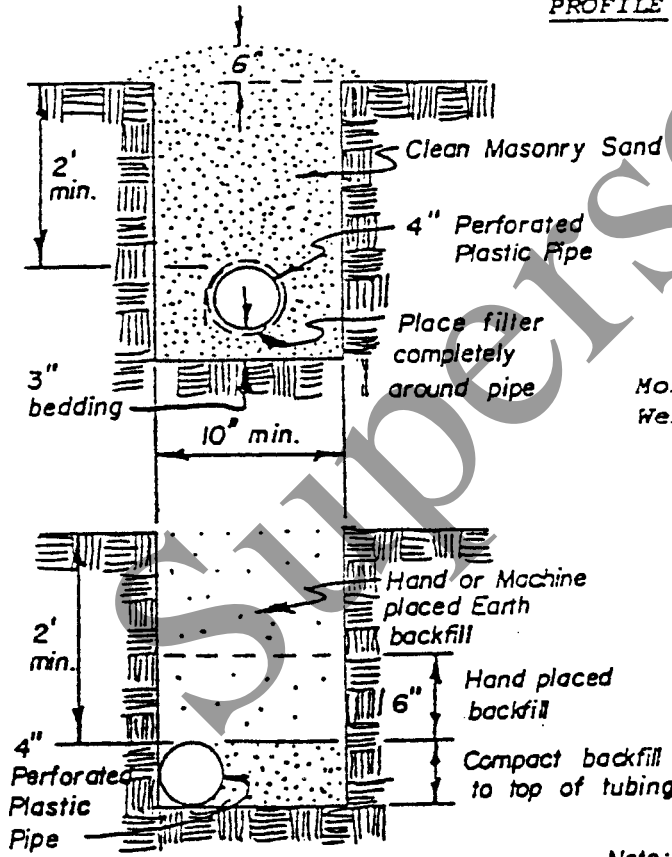

CROSS SECTIONS
DRAIN PIPE IN TRENCH

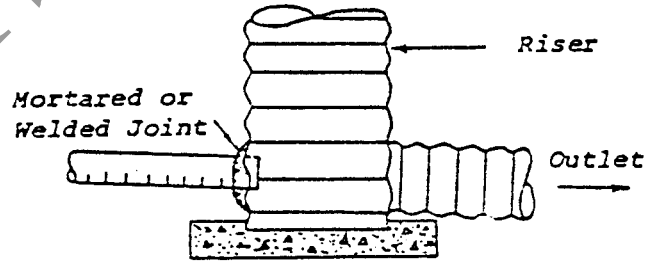

RISER CONNECTION

Note: For Rapid Dewatering use upper section;
When dewatering time is not important, earth
may be used for the backfill material as
shown in lower section.

APPENDIX A4

CHANNEL STABILITY ANALYSIS PROCEDURE

Introduction

The evaluation or design of any water conveyance system that includes earth channels requires knowledge of the relationships between flowing water and the earth materials forming the boundary of the channel, as well as an understanding of the expected stream response when structures, lining, vegetation, or other features are imposed. These relationships may be the controlling factors in determining channel alignment, grade, dimensioning of cross section and selection of design features to assure the operational requirements of the system.

The methods included herein to evaluate channel stability against the flow forces are for bare earth. The magnitude of the channel instability needs to be determined in order to evaluate whether or not structural measures are needed. Where such practices or measures are required, methods of analysis that appropriately evaluate the stream's response should be used.

All terms used in this appendix are defined in the glossary, see page A4.24.

Allowable Velocity Approach

General

This method of testing the erosion resistance of earth channels is based on data collected by several investigators.

Figure A4-1 shows "Allowable Velocities for Unprotected Earth Channels" developed chiefly from data by Fortier and Scobey al., Lane a2., by investigators in the U.S.S.R. a3, and others.

Stability is influenced by the concentration of fine material carried by the flow in suspension. There are two distinct types of flow depending on concentration of material in suspension.

1. Sediment free flow is defined as the condition in which fine material is carried in suspension by the flow at concentrations so low that it has no effect on channel stability. Flows with concentrations lower than 1,000 ppm by weight are treated as sediment free flows.
2. Sediment laden flow is the condition in which the flow carries fine material in suspension at moderate to high concentrations so that stability is enhanced either through replacement of dislodged particles or through formation of a protective cover as the result of settling. Flows in this class carry sediment in suspension at concentrations equal or larger than 20,000 ppm by weight.

Sediment transport rates are usually expressed in tons per day. To convert them into concentration use the equation:

$$C = 370 \frac{Q_s}{Q} \quad (\text{Eq. A4-1})$$

Depending on the type of soil, the effect of concentration of fine sediment (material smaller than 0.074 mm) in suspension on the allowable velocity is obtained from the curves on Figure A4-1.

If the suspended sediment concentration equals or exceeds 20,000 ppm by weight, use the sediment laden curve on Figure A4-1. If the suspended sediment concentration is 1,000 ppm or less by weight, use the sediment free curve on Figure A4-1. A linear interpolation may be made between these curves for suspended sediment concentrations between 1,000 ppm and 20,000 ppm.

Adjustment in the basic velocity to reflect the modifying effects of frequency of runoff, curvature in alignment, bank slopes, density of bed and bank materials, and depth of flow are made using the adjustment curves on Figure A4-1.

The alignment factor, A, and the depth factor, D, apply to all soil conditions. The bank slope factor, B, applies only to channels in soils that behave as discrete particles. The frequency correction, F, applies only to channels in soils that resist erosion as a coherent mass. The density correction factor, C_e , applies to all soil materials except clean sands and gravels (containing less than 5 percent material passing size #200).

Figure A4-1 gives the correction factors (F) for frequencies of occurrence lower than 10 percent. Channels designed for less frequent flows using this correction factor should be designed to be stable at the 10 percent chance frequency discharge as well as at the design discharge.

If the soils along the channel boundary behave as discrete particles with D_{75} larger than 0.4 mm for sediment laden flow or larger than 2.0 mm for sediment free flow, the allowable velocity is determined by adjusting the basic velocity read from the curves on Figure A4-1 for the effects of alignment, bank slope, and depth. If the soils behave as discrete particles and D_{75} is smaller than 0.4 mm for sediment laden flow or 2.0 mm for sediment free flow, the allowable velocity is 2.0 fps. For channels in these soils, no adjustments are to be made to the basic velocity of 2.0 fps.

In cases where the soils in the channel boundary resist erosion as a coherent mass, the allowable velocity is determined by adjusting the basic velocity from Figure A4-1 for the effects of depth, alignment, bank slope, frequency of occurrence of design flow, and for the density of the boundary soil materials.

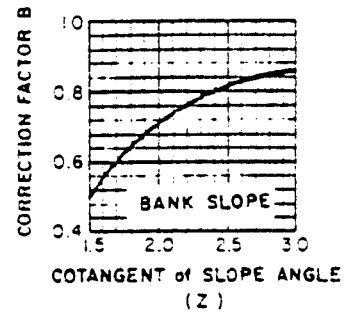
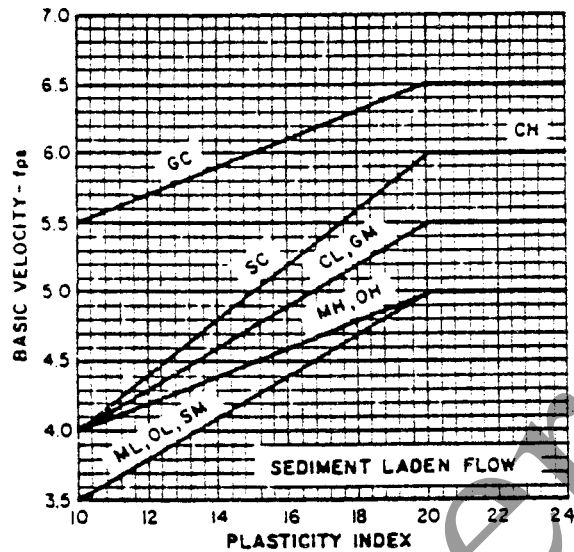
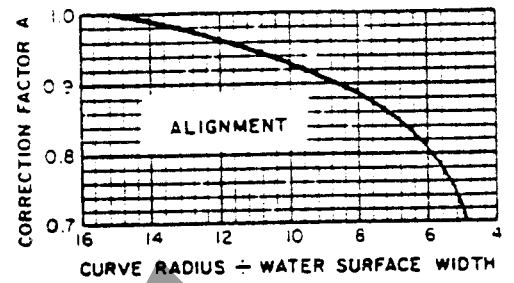
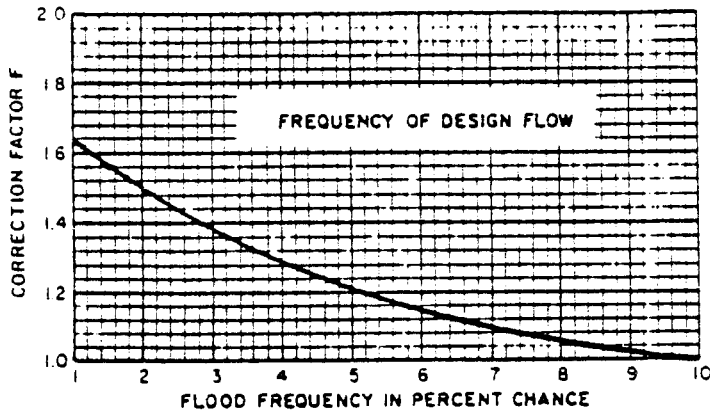

BASIC VELOCITIES FOR COHERENT EARTH MATERIALS (v_b)

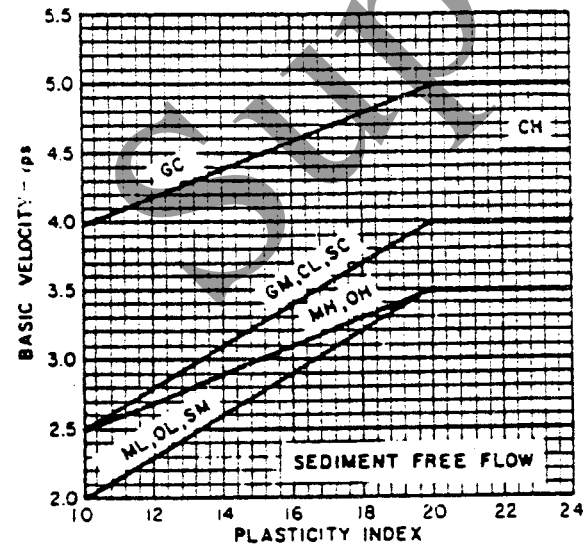

BASIC VELOCITIES FOR COHERENT EARTH MATERIALS (v_b)

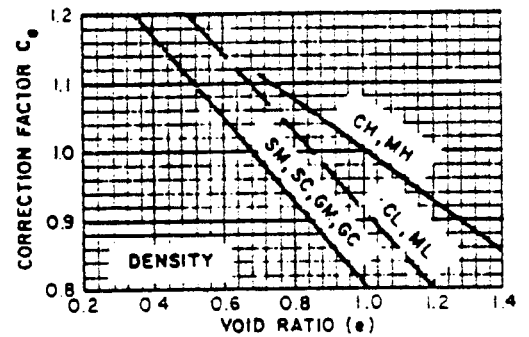

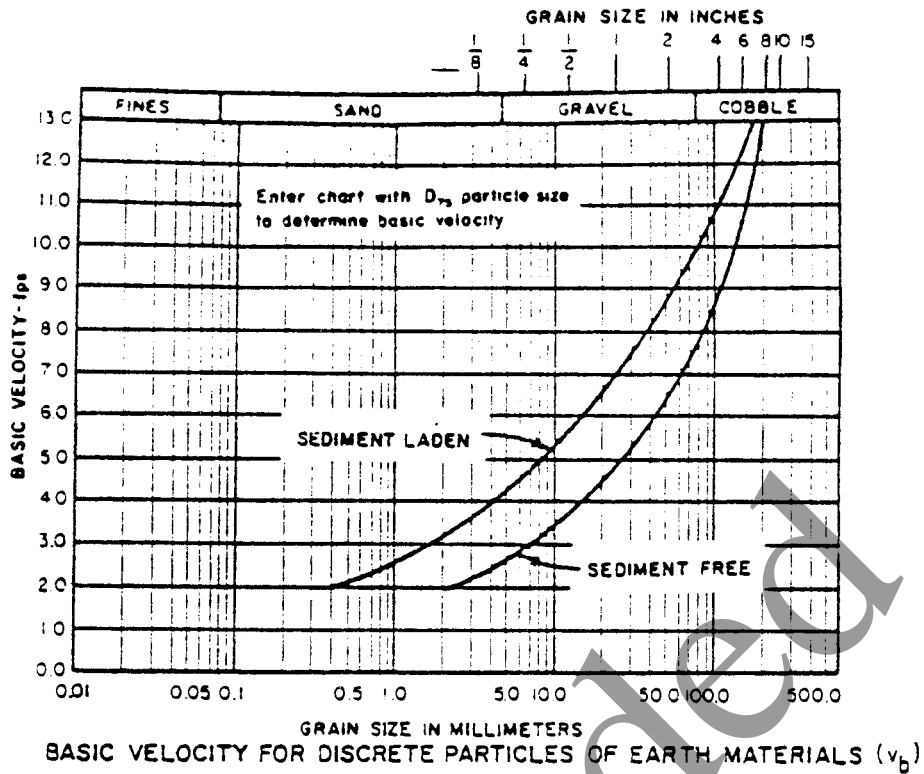

ALLOWABLE VELOCITIES FOR UNPROTECTED EARTH CHANNELS	
CHANNEL BOUNDARY MATERIALS	ALLOWABLE VELOCITY
DISCRETE PARTICLES	
Sediment Laden Flow	
$D_{75} > 0.4 \text{ mm}$	Basic velocity chart value $\times D \times A \times B$
$D_{75} < 0.4 \text{ mm}$	2.0 fps
Sediment Free Flow	
$D_{75} > 2.0 \text{ mm}$	Basic velocity chart value $\times D \times A \times B$
$D_{75} < 2.0 \text{ mm}$	2.0 fps
COHERENT EARTH MATERIALS	
$P_i > 10$	Basic velocity chart value $\times D \times A \times F \times C_e$
$P_i < 10$	2.0 fps

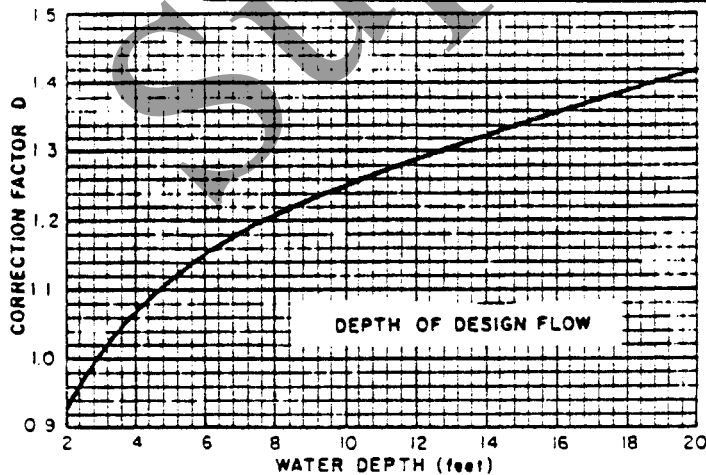

NOTES:

1. In no case should the allowable velocity be exceeded when the 10% chance discharge occurs, regardless of the design flow frequency.
2. The maximum permissible velocity for bare sand channels is 1.75 fps.

FIGURE A4-1
ALLOWABLE VELOCITIES
FOR UNPROTECTED EARTH CHANNELS

Design Procedure for Allowable Velocity Approach

The use of the allowable velocity approach in checking the stability of earth channels involves the following steps:

1. Determine the hydraulics of the system. This includes hydrologic determinations as well as the stage-discharge relationships for the channel considered.
2. Determine the properties of the earth materials forming the banks and bed of the design reach and of the channel upstream.
3. Determine sediment yield to attain and calculate sediment concentration for design flow. In most cases, sediment free conditions exist and should be used unless the designer can prove otherwise.
4. Check to see if the allowable velocity procedure is applicable.
5. Compare the design velocities with the allowable velocities from Figure A4-1 for the materials forming the channel boundary.

Examples of Allowable Velocity Approach

Example 1

Given: A channel is to be constructed to convey the flow from a 2 percent chance flood. The hydraulics of the system indicate that a trapezoidal channel with 2:1 side slopes and a 40 foot bottom width will carry the design flow at a depth of 8.7 feet and a velocity of 5.45 fps. Soil investigations reveal that the channel will be excavated in a moderately rounded clean sandy gravel with a D75 size of 2.25 inches. Sampling of soils in the drainage area and estimate of erosion and sediment yield indicate that, on an average annual basis, approximately 1000 tons of sediment finer than 1.0 mm. and 20 tons of material coarser than 1.0 mm are available for transport in channel. The amount of abrasion resulting from the transporting of this small amount of sediment coarser than 1.0mm is considered insignificant. Sediment transport computations indicate all of the sediment supplied to the channel will be transported through the reach. The sediment transport and hydrologic evaluations indicate the design flow will transport the available sediment at a concentration of about 500 ppm. The channel is straight except for one curve with a radius of 600 feet.

Determine:

1. The allowable velocity, V_a , and
2. The stability of the reach.

Solution: Determine basic velocity from Figure A4-1, sediment free curve because sediment concentration of 500 ppm is less than 1,000 ppm.

$$V_b = 6.7 \text{ fps.}$$

Depth correction factor, $D = 1.22$ (from Figure A4-1).

Bank slope correction, $B = 0.72$ (from Figure A4-1).

Alignment correction A,

$$\frac{\text{curve radius}}{\text{water surface width}} = \frac{600}{74.8} = 8.02$$

$A = 0.89$ (from Figure A4-1).

Density correction, C_e , does not apply.

Frequency correction, F , does not apply.

$$V_a \text{ (straight reaches)} = V_b DB = (6.7) (1.22) (0.72) = 5.88 \text{ fps}$$

$$V_a \text{ (curved reaches)} = V_b DBA = (6.7) (1.22) (0.72) (0.89) = 5.24 \text{ fps}$$

The proposed design velocity of 5.45 fps is less than $V_a = 5.88$ fps in the straight reaches but greater than $V_a = 5.24$ fps in the curved reaches. Either the channel alignment or geometry needs to be altered or the curve needs structural protection.

Example 2

Given: A channel is to be constructed to convey the flow from a 2 percent chance flood. The hydraulics of the system indicate that a trapezoidal channel with 2:1 side slopes and a 40 foot bottom width will carry the design flow at a depth of 8.7 feet and a velocity of 5.45 fps. The channel is to be excavated into a silty clay (CL) soil with a Plasticity Index of 18, a dry density of 92 pcf, and a specific gravity of 2.71. Sediment transport evaluations indicate the design flow will have a fairly stable sediment concentration of about 500 ppm with essentially no bed material load larger than 1.0 mm. The channel is straight except for one curve with a radius of 600 feet. The 10 percent chance flood results in a depth of flow of 7.4 feet and a velocity of 4.93 fps.

Determine:

1. The allowable velocity, V_a , and
2. The stability of the reach.

Solution: Sediment concentration of 500 ppm is less than 1,000 ppm, therefore it is classed as sediment free flow.

$$V_b = 3.7 \text{ fps (from Figure A4-1)} \\ \text{for the 2 percent chance flood.}$$

Depth correction, $D = 1.22$ (from Figure A4-1).

Density correction, compute e;

$$e = G \frac{\gamma_w}{\gamma_d} - 1 = \frac{(2.71)(62.4)}{92} - 1 = 0.83$$

Ce = 1.0 (from Figure A4-1).

Alignment correction A,

$$\frac{\text{Curve radius}}{\text{water surface width}} = \frac{600}{74.8} = 8.02$$

A = 0.89 (from Figure A4-1).

$$V_a \text{ (Straight reach)} = V_b D C_e F = (3.7)(1.22)(1.0)(1.5) = 6.77 \text{ fps.}$$

$$V_a \text{ (Curved reach)} = V_b D C_e F A = (3.7)(1.22)(1.0)(1.5)(0.89) = 6.03 \text{ fps.}$$

The design velocity is less than the allowable velocity for the 2 percent chance flow. Check the 10 percent chance flow velocity with no frequency correction against the allowable velocity for the 10 percent chance flow.

$$V_a \text{ (Straight reaches)} = V_b D C_e = (3.7)(1.19)(1.0) = 4.40 \text{ fps.}$$

$$V_a \text{ (Curved reaches)} = V_b D C_e A = (3.7)(1.19)(1.0)(0.90) = 3.96 \text{ fps.}$$

The allowable velocity with no frequency correction is exceeded by the 10 percent chance flow velocity. Channel alignment, slope or geometry must be altered or the channel must be protected.

Tractive Stress Approach

General

The tractive force is the tangential pull of flowing water on the wetted channel boundary; it is equal to the total friction force that resists flow but acts in the opposite direction. Tractive stress is the tractive force per unit area of the boundary. The tractive force is expressed in units of pounds, while tractive stress is expressed in units of pounds per square foot. The tractive force in a prismatic channel reach is equal to the weight of the fluid prism multiplied by the energy gradient.

The tractive stress approach to channel stability analysis provides a method to evaluate the stress at the interface between flowing water and the materials in the channel boundary.

The method for obtaining the actual tractive stress acting on the bed or sides of a channel and the allowable tractive stress depends on the D₇₅ size of the materials involved. When coarse grained discrete particle soils are involved, Lane's a₂ method is used. When fine grained soils are involved, a method derived from the work of Keulegan and modified by Einstein a₄., and Vanoni and Brooks, a₅., is used. The separation size for this determination is D₇₅ - 1/4 inch.

Coarse-grained Discrete Particle Soils - $D_{75} > 1/4$ inch - Lane's Method

A. Determination of Actual Tractive Stress

1. Actual tractive stress in an infinitely wide channel.

Generally, Manning's roughness coefficient "n" reflects the overall impedance to flow including grain roughness, form roughness, vegetation, curved alignment, etc. Lane's a2 work showed that for soils with a D_{75} size between 0.25" (6.35 mm) and 5.0" (127mm) the value of Manning's coefficient "n" resulting from the roughness of the soil particles is determined by:

$$n_t = \frac{D_{75}^{1/6}}{39} \quad \text{with } D_{75} \text{ expressed in inches (Eq. A4-2)}$$

The value of n_t determined by the equation above represents the retardance to flow caused by roughness of the soil grains.

The value of n_t can be used to compute s_t , the friction gradient associated with the particular boundary material being considered.

(Eq. A4-3)

$$s_t = \left(\frac{n_t}{n} \right)^2 s_e$$

The tractive stress acting on the soil grains in an infinitely wide channel is found by:

$$\tau_{\infty} = \gamma_w d s_t \quad \text{(Eq. A4-4)}$$

where the terms are as defined in the glossary.

2. Distribution of the tractive stress along the channel perimeter:

In open channels the tractive stresses are not distributed uniformly along the perimeter. Laboratory experiments and field observations have indicated that in trapezoidal channels the stresses are very small near the water surface and near the corners of the channel and assume their maximum value near the center of the bed. The maximum value on the banks occurs near the lower third point.

Figure A4-2 and A4-3 give the maximum tractive stresses in a trapezoidal channel in relation to the tractive stress in an infinitely wide channel having the same depth of flow and value of s_t .

3. Tractive stresses on curved reaches:

Curves in channels cause the maximum tractive stresses to increase above those in straight channels. The maximum tractive stresses in a channel with a single curve occur on the inside bank in the upstream portion of the curve and near the outer bank downstream from the curve. Compounding of curves in a channel complicates the flow pattern and causes a compounding of the maximum tractive stresses.

Figure A4-4 gives values of maximum tractive stresses based on judgment coupled with very limited experimental data. It does not show the effect of depth of flow and length of curve and its use is only justified until more accurate information is obtained. Figure A4-5, with a similar degree of accuracy, gives the maximum tractive stresses at various distances downstream from the curve.

B. Allowable Tractive Stress

The allowable tractive stress for channel beds, τ_{Lb} , composed of soil particles with discrete, single grain behavior with a given D_{75} is:

$$\tau_{Lb} = 0.4 D_{75}$$

When $0.25 \text{ in} < D_{75} < 5.0 \text{ in}$. (Eq. A4-5)

The allowable tractive stress for channel sides, τ_{Ls} is less than that of the same material in the bed of the channel because the gravity force aids the tractive stress in moving the materials. The allowable tractive stress for channel sides composed of soil particles behaving as discrete single grain materials, considering the effect of the side slope z and the angle of repose ϕ_R with the horizontal is

$$\tau_{Ls} = 0.4 K D_{75} \dots 0.25 \text{ in} < D_{75} < 5.0 \text{ in}. \quad (\text{Eq. A4-6})$$

Where: $K = \sqrt{\frac{z^2 - \cot^2 \phi_R}{1 + z^2}} \dots \quad (\text{Eq. A4-7})$

Figure A4-6 gives an evaluation of the angles of repose corresponding to the degree of angularity of the material. Figure A4-7 gives values of K from Equation A4-7.

When the unit weight γ_s of the constituents of the material having a grain size larger than the D_{75} size is significantly different than 160 lb/ft^3 , the limiting tractive stress τ_{Lb} and τ_{Ls} as given by Equations (A4-5) and (A4-6) should be multiplied by the factor.

$$T = \frac{\gamma_s - \gamma_w}{97.6} \quad (\text{Eq. A4-8})$$

Fine Grained Soils - $D_{75} < 1/4 \text{ inch}$

A. Determination of Actual Tractive Stress

1. Reference tractive stress -

The expression for reference tractive stress is:

$$\tau = \gamma_w R_t s_e \quad (\text{Eq. A4-9})$$

In a given situation V and s_e are known so that the only unknown is R_t . The value of R_t can be determined from the logarithmic frictional formula developed by Keulegan and modified by Einstein a4.

$$\frac{V}{\sqrt{g R_t s_e}} = 5.75 \log \left(12.27 \frac{R_t x}{k_s} \right) \quad (\text{Eq. A4-10})$$

where: k_s is the D_{65} size in ft.

The factor x in Equation A4-10 describes the effect on the frictional resistance of the ratio of the characteristic roughness length k_s to the thickness of the laminar sublayer δ . This thickness is determined from the equation:

$$\delta = \frac{11.6 \nu}{\sqrt{g R_t s_e}} \quad (\text{Eq. A4-11})$$

A relationship between x and k_s/δ has been developed empirically by Einstein a4., and represented by a curve. With the help of this curve and equations A4-10 and A4-11, the value of R_t can be determined provided that V , s_e , k_s and the temperature of the water are known. The computational solution for R_t follows an iterative procedure which is rather involved. A simpler graphical solution has been developed by Vanoni and Brooks a5, and the basic family of curves that constitute it is shown in Figure A4-8. Figure A4-9 shows the extension of the curves outside the region covered in the original publication.

Figure A4-10 gives curves from which values of density ρ and kinematic viscosity of the water ν can be obtained.

The computation of reference tractive stress (τ) is facilitated by following the procedure on page A4.20.

2. Distribution of the tractive stress along the channel perimeter:

In open channels the tractive stresses are not distributed uniformly along the perimeter. Laboratory experiments and field observations have indicated that in trapezoidal channels the

REFERENCE:
 Bureau of Reclamation "Progress Report
 on Results of Studies on Design of Stable
 Channels" Hyd-352

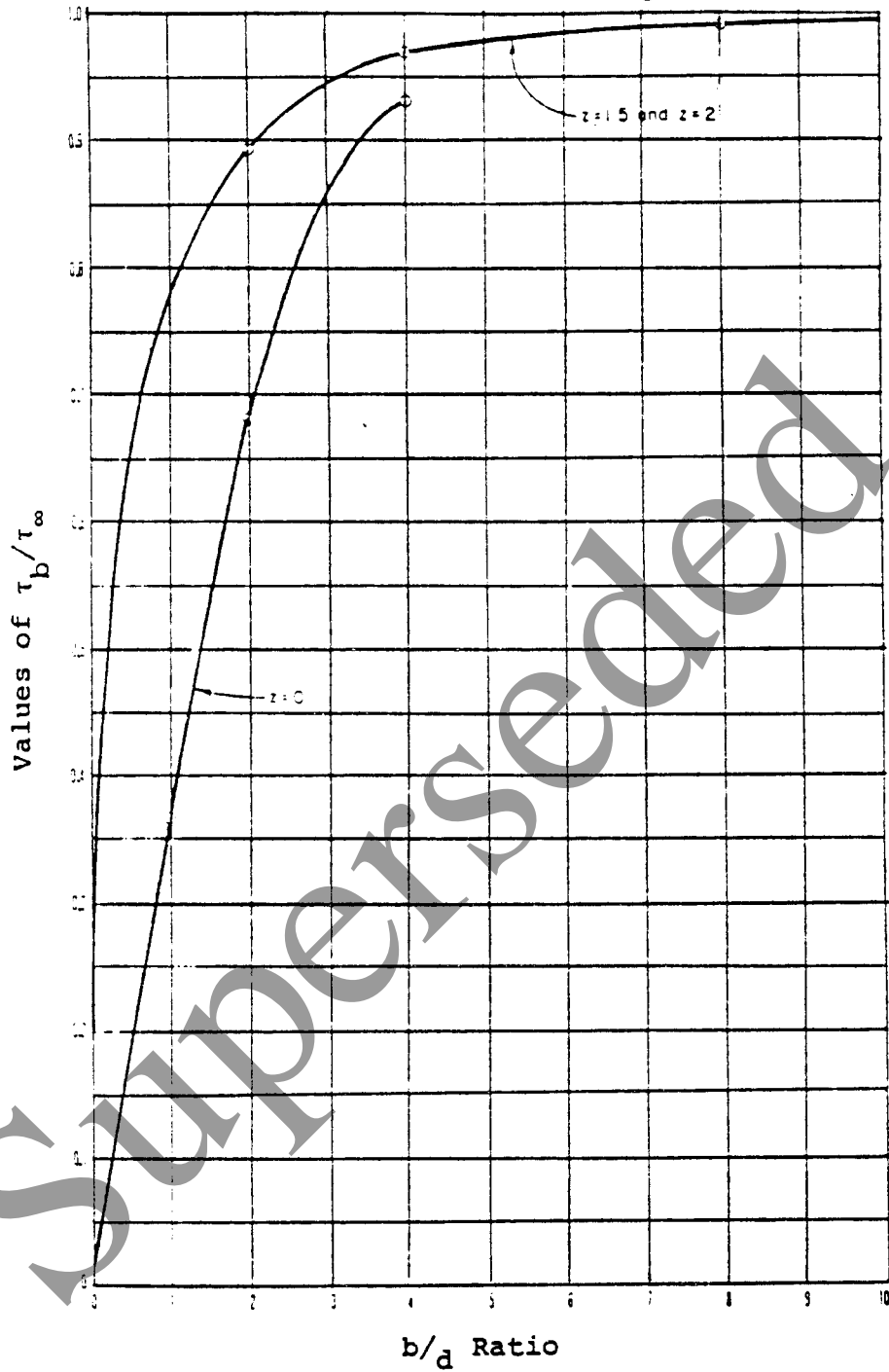

FIGURE A4-2

CHANNEL STABILITY: ACTUAL MAXIMUM TRACTIVE STRESS, τ_b , ON BED OF STRAIGHT TRAPEZOIDAL CHANNELS

REFERENCE

Bureau of Reclamation "Progress Report
of Results of Studies on Design of
Stable Channels" Hyd-352

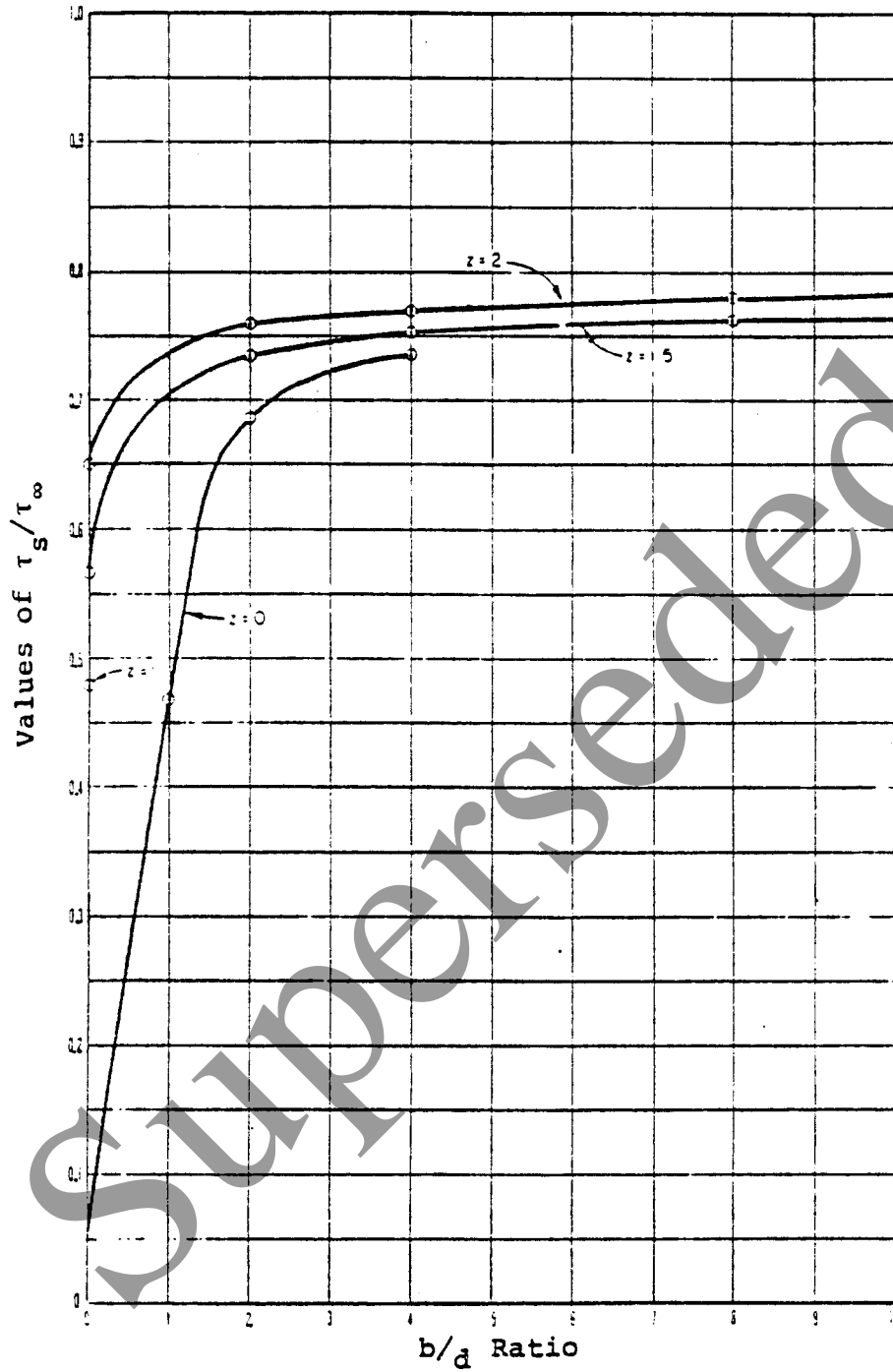

FIGURE A-4-3

CHANNEL STABILITY; ACTUAL MAXIMUM TRACTIVE STRESS, τ_s , ON SIDES
OF STRAIGHT TRAPEZOIDAL CHANNELS

REFERENCE:

Lane, Emory W., Design of Stable Channels
Transaction, A S C E, vol. 120, 1955

Nece, R.E., Givler, G.A., and Drinker, P.A.,
Measurement of Boundary Shear Stress in an
Open Curve Channel with a Surface Pitot Tube:
M.I.T. Tech. note (no. 6), Aug. 1959

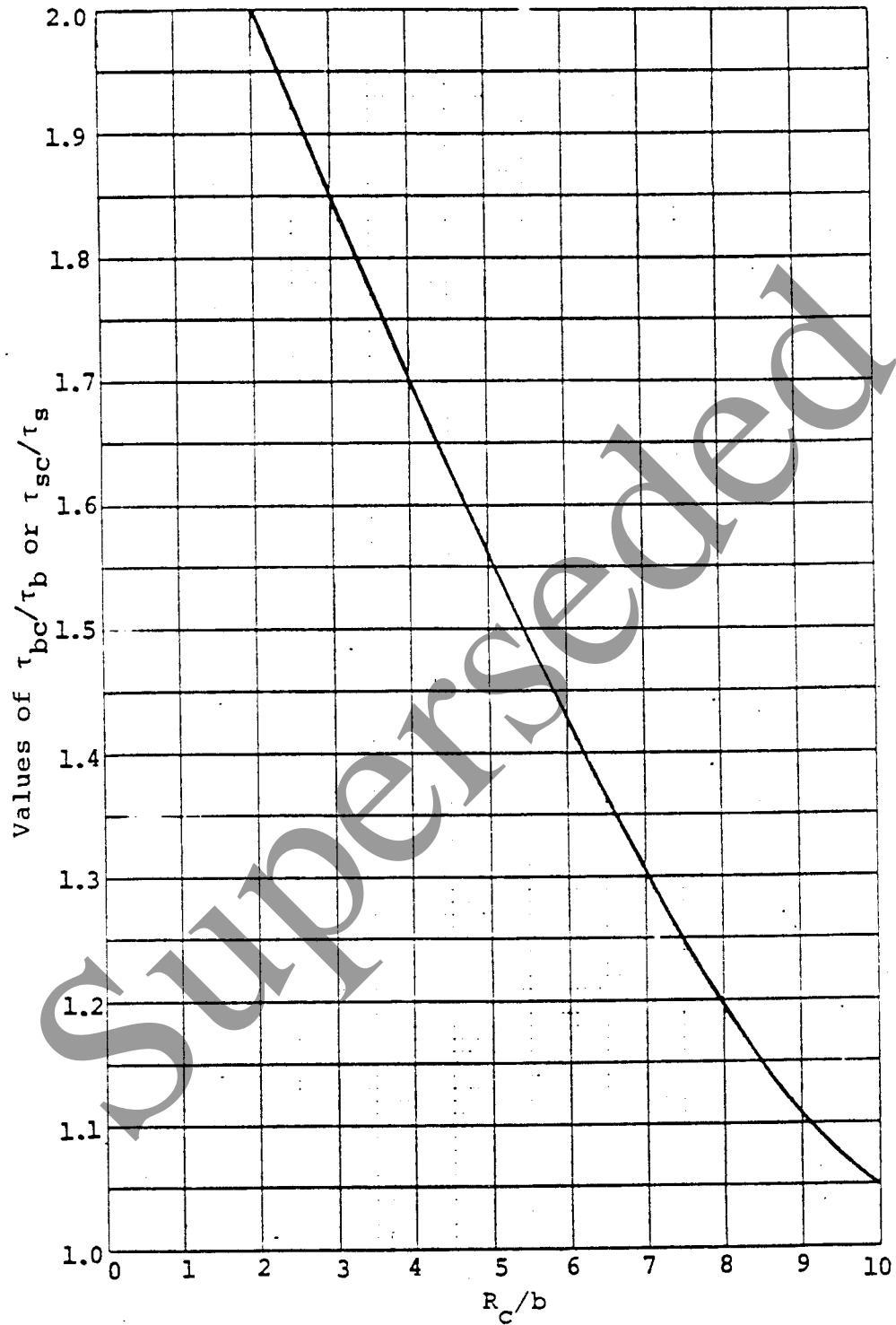

FIGURE A-4

CHANNEL STABILITY; ACTUAL MAXIMUM TRACTIVE STRESS, τ_{bc} AND τ_{sc} ,
ON BED AND SIDES OF TRAPEZOIDAL CHANNELS WITHIN A CURVED REACH

REFERENCE
 Nece, R.E., Givler, G.A., and Drinker, P.A.,
 Measurement of Boundary Shear Stress in an
 Open Curve Channel with a Surface Pitot
 Tube: M.I.T. Tech notes (no.6), Aug. 1959

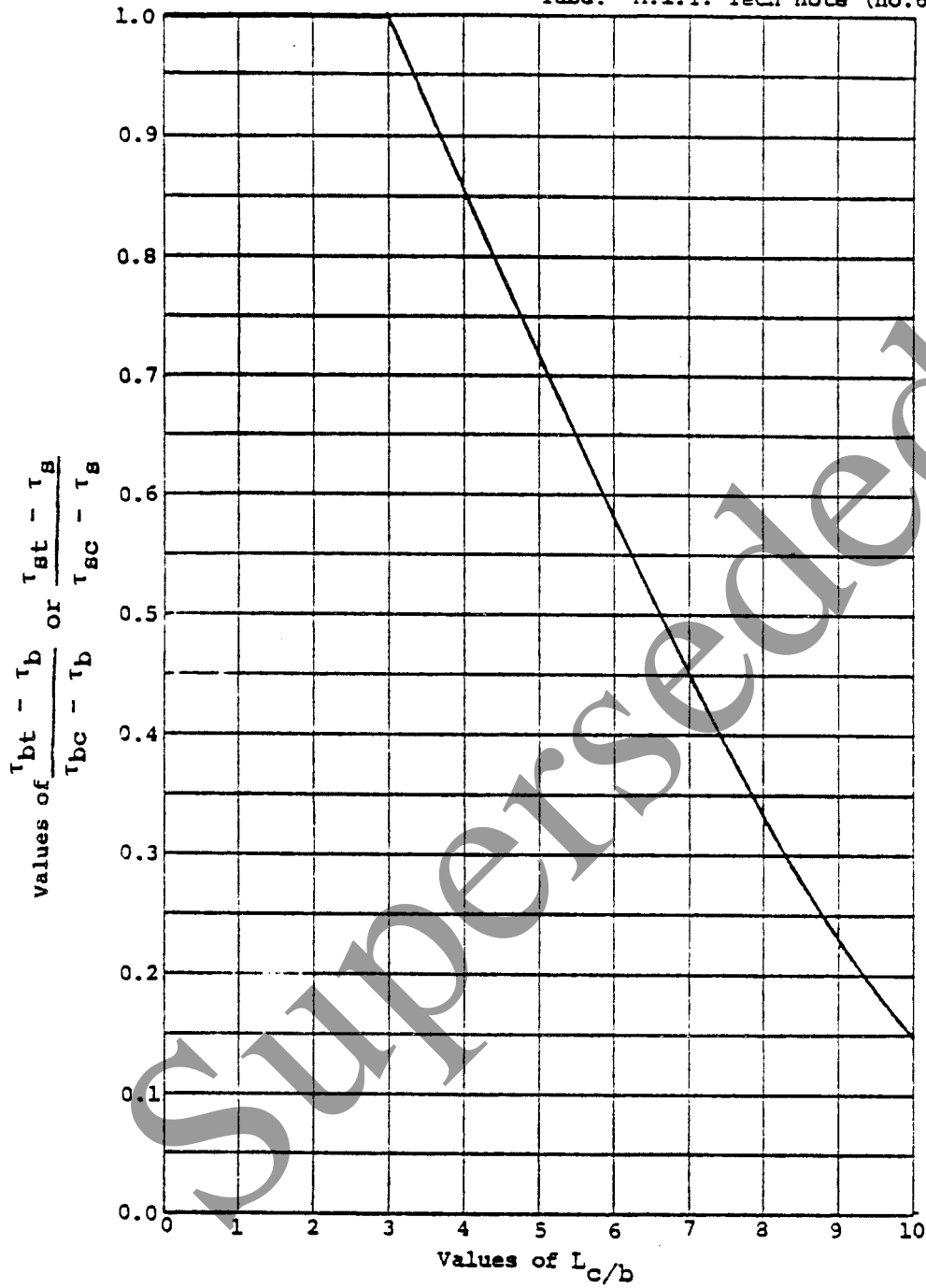

FIGURE A4-5

CHANNEL STABILITY; ACTUAL MAXIMUM TRACTIVE STRESSES τ_{bt} AND τ_{st} ,
 ON BED AND SIDES OF TRAPEZOIDAL CHANNELS IN STRAIGHT REACHES
 IMMEDIATELY DOWNSTREAM FROM CURVED REACHES

REFERENCE
 Bureau of Reclamation Progress Report of
 Results of Studies on Design of Stable
 Channels
 Hyd-352

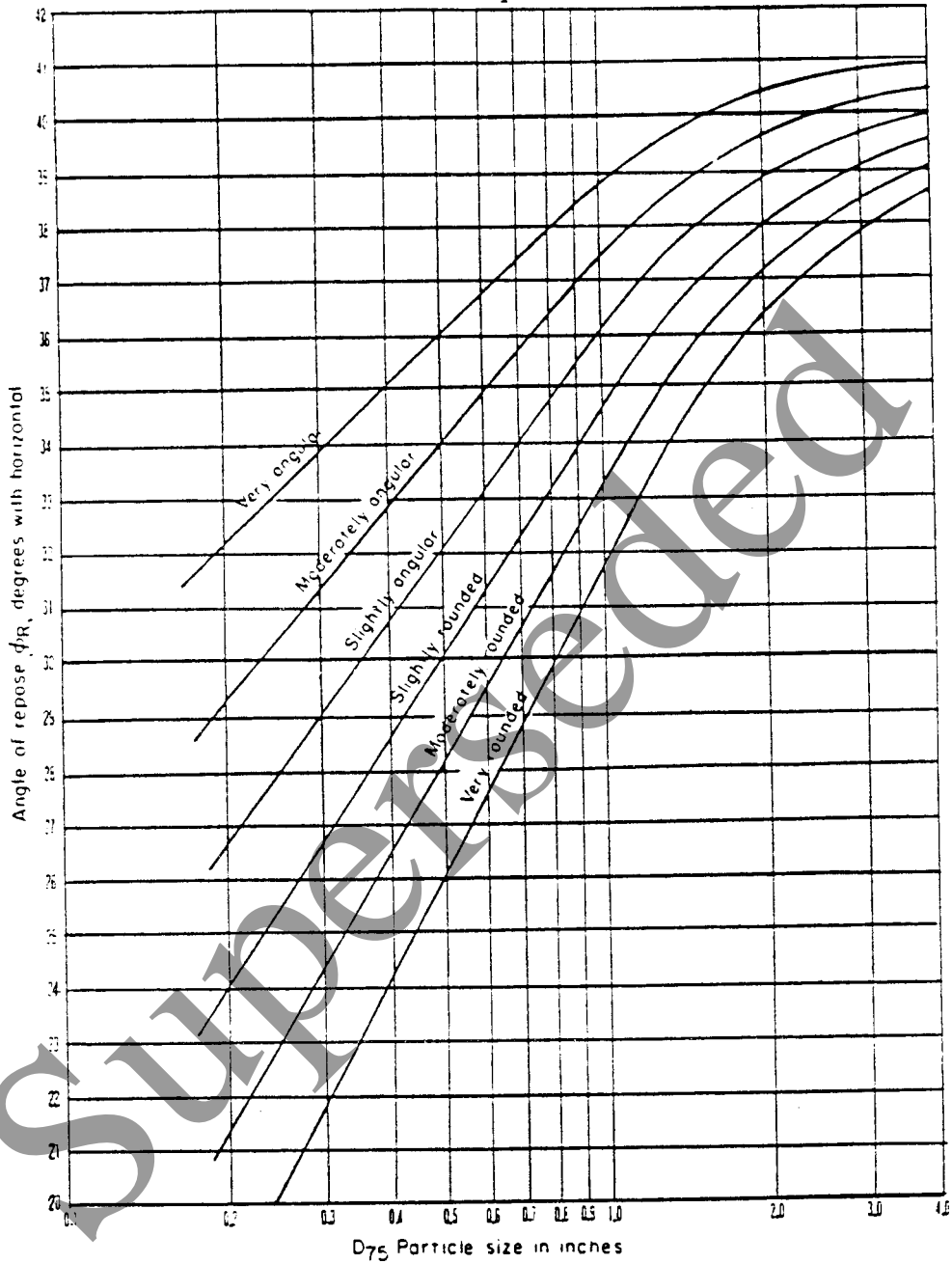

FIGURE A4-6

CHANNEL STABILITY; ANGLE OF RESPOSE, ϕ_R , FOR NON-COHESIVE MATERIALS

REFERENCE:

Bureau of Reclamation "Progress Report
on Results of Studies on Design of
Stable Channels"
Hyd-352

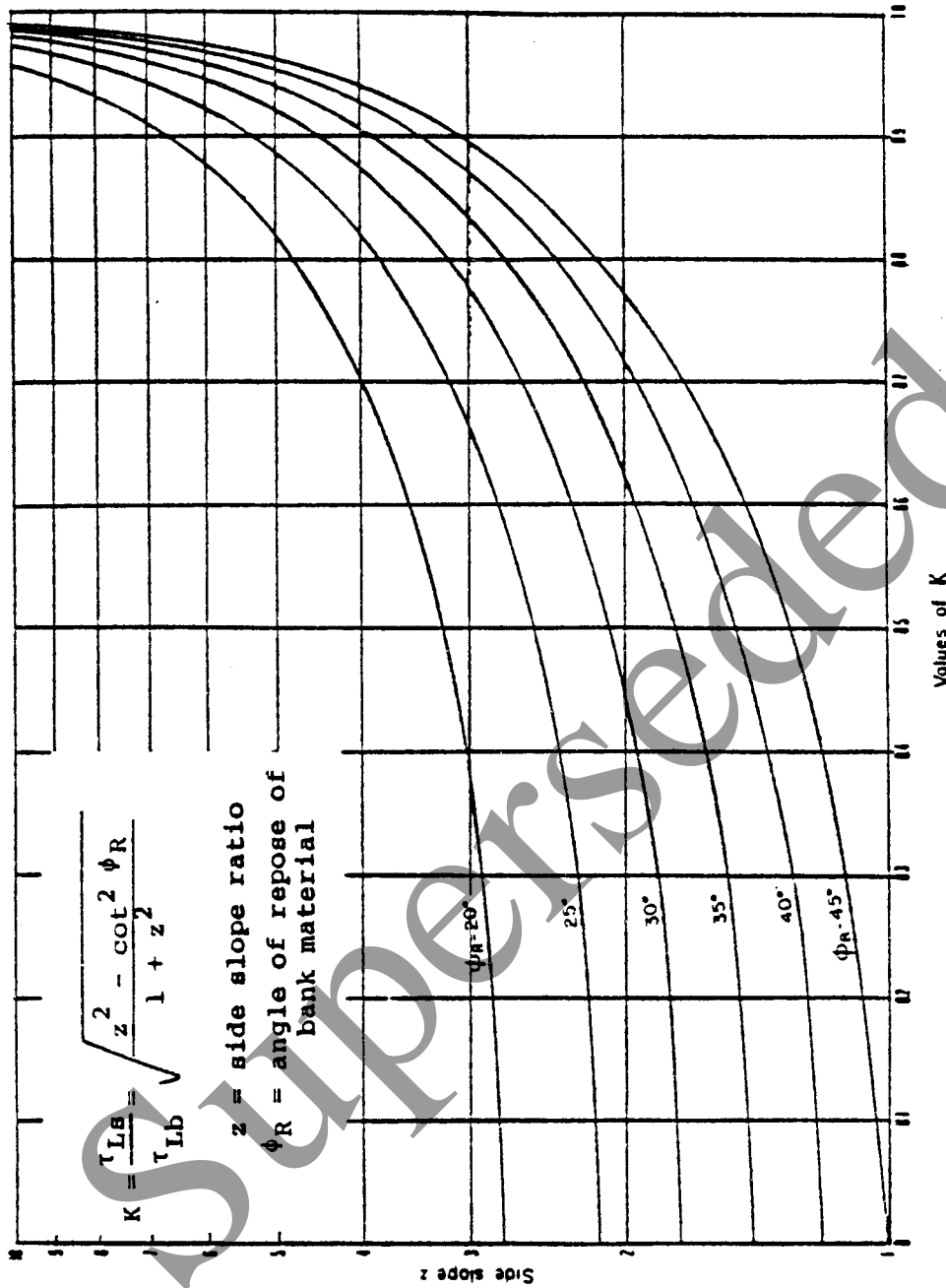

FIGURE A4-7

CHANNEL STABILITY; LIMITING TRACTIVE STRESS τ_{Ls} FOR SIDES OF
TRAPEZOIDAL CHANNELS HAVING NON-COHESIVE MATERIALS

stresses are very small near the water surface and near the corners of the channel and assume their maximum value near the center of the bed. The maximum value on the banks occurs near the lower third point.

The graphs in Figures A4-11 and A4-12 may be used to evaluate maximum stress values on the banks and the bed respectively. These figures are to be used along with τ , the reference tractive stress, to obtain values for the maximum tractive stress on the sides and bed of trapezoidal channels in fine grained soils.

3. Tractive stresses in curved reaches:

Figures A4-4 and A4-5, used to determine the maximum tractive stresses in curved reaches for coarse grained soils, may also be used to obtain these values for fine grained soils. The values for the maximum tractive stresses on the beds and sides, as determined above, are used in conjunction with these charts to obtain values for curved reaches.

B. Allowable Tractive Stresses - Fine grained soils

The stability of channels in fine grained soils ($D_{75} < 0.25"$) may be checked using the curves in Figure A4-13. These curves were developed by Lane a2. The curves relate the median grain size of the soils to the allowable tractive stress. Curve 1 is to be used when the stream under consideration carries a load of 20,000 ppm by weight or more of fine suspended sediment. Curve 2 is to be used for streams carrying up to 2,000 ppm by weight of fine suspended sediment. Curve 3 is for sediment free flows (less than 1,000 ppm).

When the value of D_{50} for fine grained soils is greater than 5 mm, use the allowable tractive stress values shown on the chart for 5mm.

For values of D_{50} less than those shown on the chart (0.1mm), use the allowable tractive stress values for 0.1 mm. However, if this is done, 0.1 mm should be used as the D_{65} size in obtaining the reference tractive stress.

Procedure - Tractive Stress Approach

The use of tractive stress to check the ability of earth channels to resist erosive stresses involves the following steps:

1. Determine the hydraulics of the channel. This includes hydrologic determinations as well as the stage-discharge relationships for the channel being considered.
2. Determine sediment yield to reach and calculate sediment concentration for design flow, or assume sediment free water.
3. Determine the properties of the earth materials in the boundary of the channel.

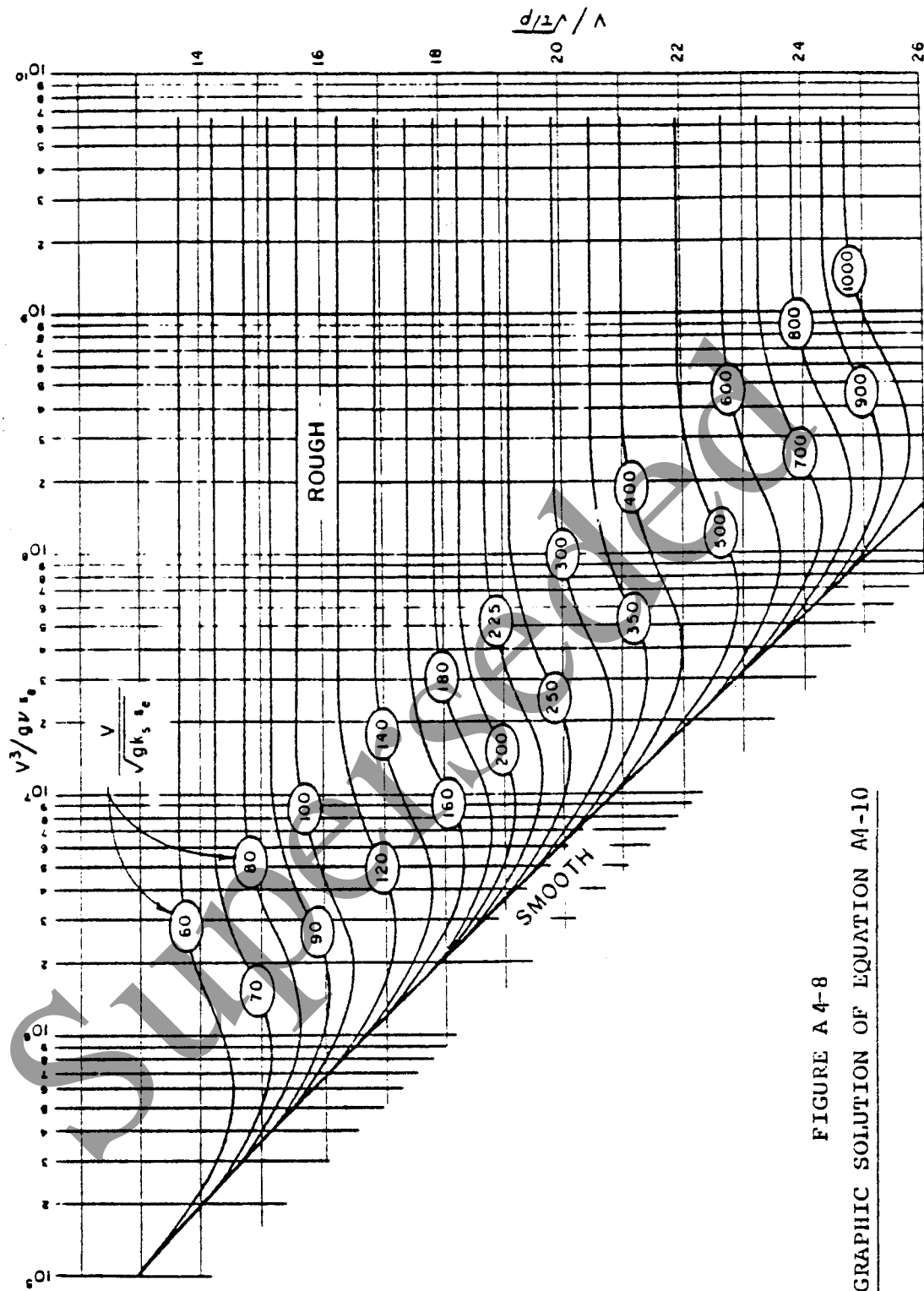

FIGURE A 4-8
 GRAPHIC SOLUTION OF EQUATION A4-10

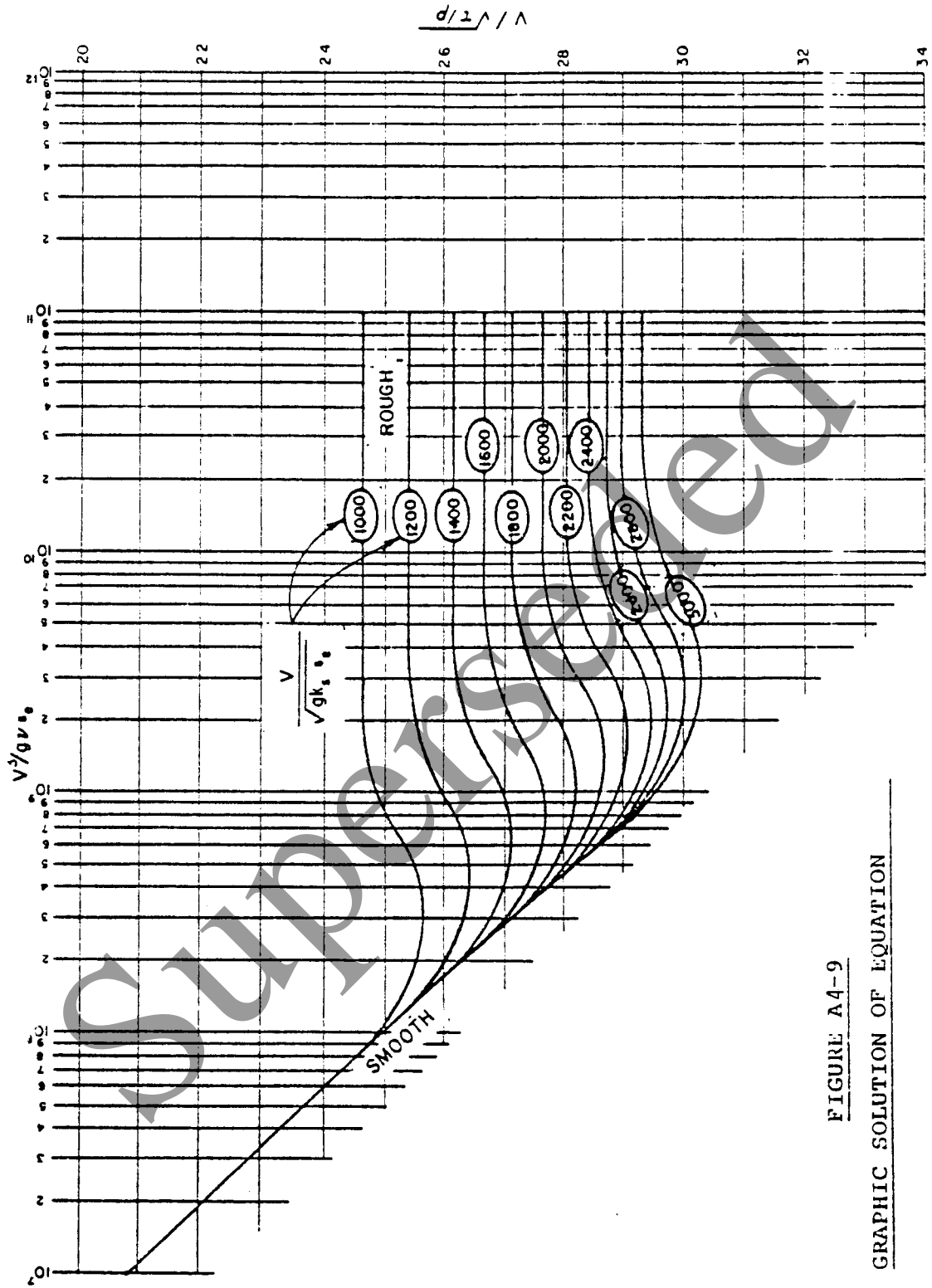

FIGURE A4-9
GRAPHIC SOLUTION OF EQUATION

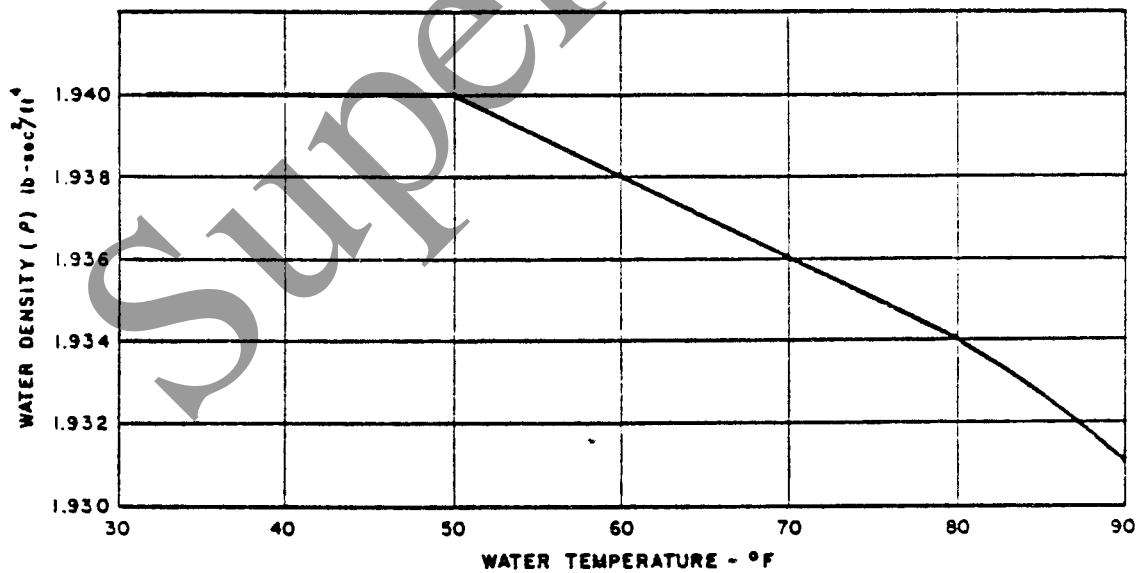
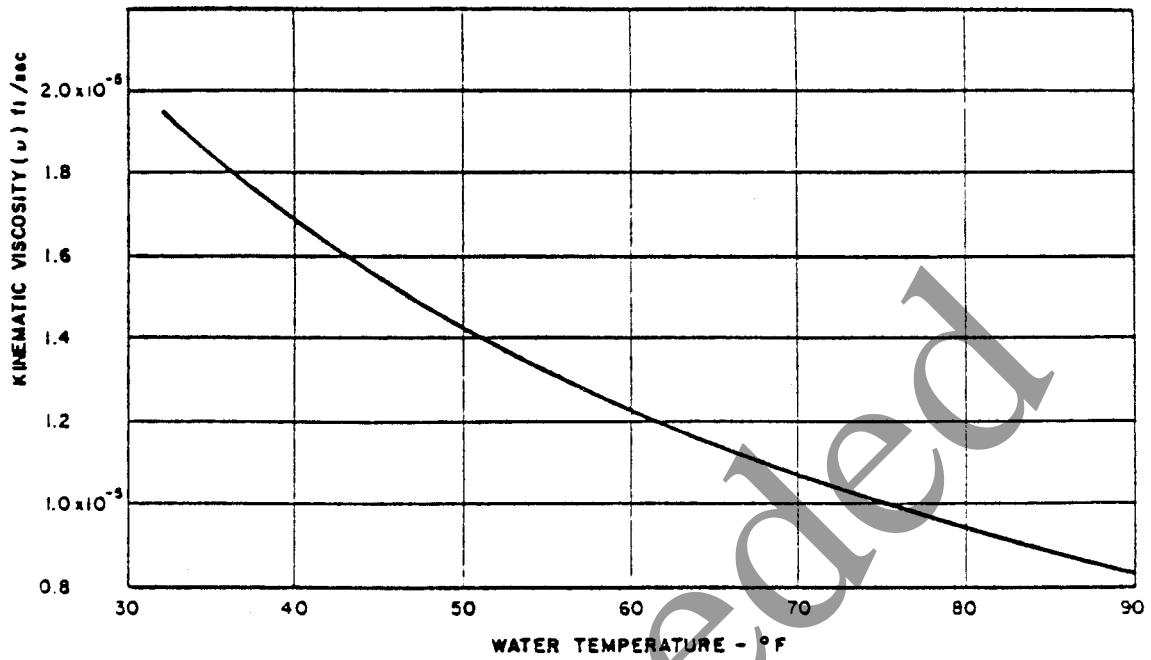

FIGURE A 4-10

VALUES OF ρ AND ν FOR VARIOUS WATER TEMPERATURES

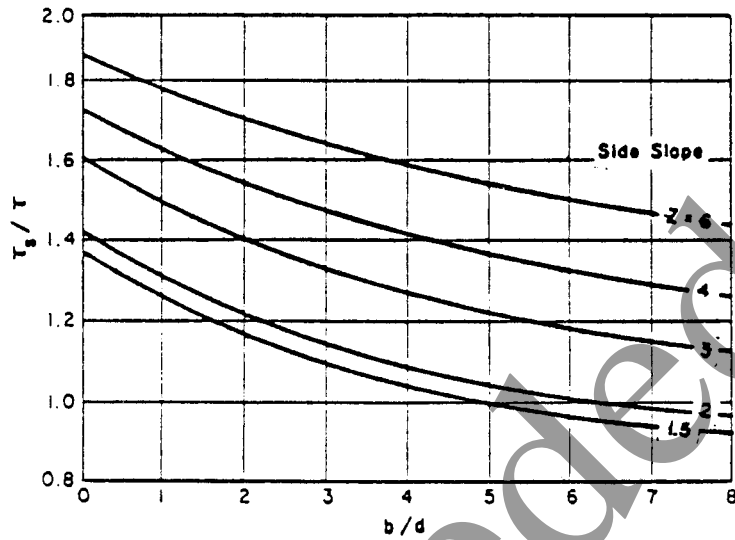

FIGURE A 4-11
APPLIED MAXIMUM TRACTIVE STRESS, τ_s ,
ON SIDES OF STRAIGHT TRAPEZOIDAL CHANNELS

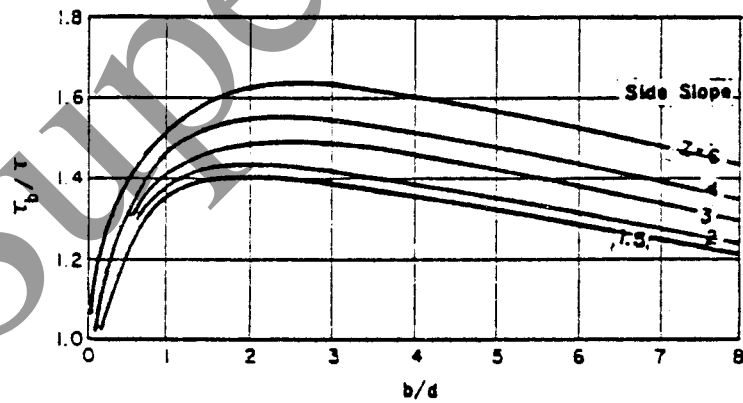

FIGURE A 4-12
APPLIED MAXIMUM TRACTIVE STRESS, τ_b ,
ON BED OF STRAIGHT TRAPEZOIDAL CHANNELS

Curves reproduced from "Tentative Design Procedure for Riprap Lined Channels" National Cooperative Highway Research Program Report No. 108

4. Check to see if the tractive stress approach is applicable.
5. Compute the tractive stresses exerted by the flowing water on the boundary of the channel being studied. Use the proper procedure as established by the D₇₅ size of the materials.
6. Check the ability of the soil materials forming the channel to resist the computed tractive stresses.

The computation for the reference tractive stress for fine grained soils is facilitated by using the following procedure:

1. Determine s_e and V : Evaluate Manning's "n" by the method described in Supplement A.
2. Enter the graphs in Figure A4-10 with the value of temperature in °F and read the density ρ and the kinematic viscosity of the water ν .
3. Compute $\frac{v^3}{g\nu s_e}$.
4. Compute $\frac{v}{\sqrt{g\kappa_s s_e}}$.
5. Enter the graph in Figure A4-8 (or Figure A4-9) with the computed values in steps 2 and 3 above and read the value of $\frac{v}{\sqrt{\tau/\rho}}$.
6. Compute τ from $\frac{v}{\sqrt{\tau/\rho}}$, v and ρ .

$$\tau = \frac{v^2 \rho}{\left(\frac{v}{\sqrt{\tau/\rho}} \right)^2}$$

where the terms are defined in the glossary

Examples - Tractive Stress Approach

Example 3

Given: The bottom width of the trapezoidal channel is 18 feet with side slopes of 1 1/2:1. The design flow is 262 cfs at a depth of 3.5 feet and a velocity of 3.23 fps. The slope of the energy grade line is 0.0026. There is one curve in the reach, with a radius of 150 feet. The aged "n" value is estimated to be 0.045. The channel will be excavated in GM soil that is nonplastic, with D₇₅ = 0.90 inches (22.0 mm). The gravel is very angular.

Determine: The actual and allowable tractive stress.

Solution: Since D₇₅ > 1/4 inch use the Lane method.

$$n_t = (0.90)^{1/6/39} = 0.0252 \quad (\text{Eq. A8-1}).$$

$$\text{From Equation A4-3: } s_t - (n_t/n)^2 s_e = (0.025/0.045)^2 0.0026 = 0.00082.$$

$$\text{actual } \tau_\infty = \gamma_w d s_t = (62.4) (3.5) (0.00082) = 0.179 \text{ psf.}$$

$$b/d \text{ (ratio of bottom width to depth)} = 18/3.5 = 5.14.$$

$$\text{from Figure A4-2 and A4-3 } \tau_s/\tau_\infty = 0.76; \tau_b/\tau_\infty = 0.98.$$

$$R_c/b = \text{(radius of curve/bottom width)} = 150/18 = 8.33.$$

$$\tau_{bc}/\tau_b = \tau_{sc}/\tau_s = 1.17 \text{ (Figure A4-4).}$$

$$\text{Actual } \tau_b = (0.179) (0.98) = 0.175 \text{ psf;}$$

$$\text{actual } \tau_s = (0.179) (0.76) = 0.136 \text{ psf}$$

$$\text{Actual } \tau_{bc} = (0.175) (1.17) = 0.205 \text{ psf;}$$

$$\text{actual } \tau_{sc} = (0.136) (1.17) = 0.159 \text{ psf}$$

Solving for allowable tractive stress -

$$\phi_R = 38.4^\circ \text{ (Figure A4-6). } K = 0.45 \text{ (Figure A4-7).}$$

$$\text{allowable: } \tau_{Lb} = (0.4) (D_{75}) = (0.4) (0.90) = 0.36$$

$$\text{allowable: } \tau_{Ls} = 0.4 K D_{75} = (0.4) (0.45) (0.90) = 0.162$$

Comparing actual with allowable, the channel will be stable in straight and curved sections.

Example 4

Given: Bottom width of the trapezoidal section is 18 feet, side slopes are 1-1/2:1. Design flow is 262 cfs, with a depth of 3.5 feet at a velocity of 3.23 fps. Slope of the hydraulic grade line is 0.0026. The design temperature is 50°F. The channel will be cut in nonplastic SM soil, with a D₇₅ size of 0.035 inches, a D₆₅ size of 0.01075 inches (0.273 mm) and a D₅₀ of 0.127 mm. The "n" value for the channel is 0.045. There are no curves in the reach. Sediment load is quite light in this locality, in the range of clear water criteria.

Determine: The actual tractive stress and the allowable tractive stress.

Solution: Since the D₇₅ size is less than 1/4 inch, use the reference tractive stress method.

$$v = 1.42 \times 10^{-5} \text{ ft}^2/\text{sec.}, \rho = 1.940 \text{ lb sec}^2/\text{ft}^4 \quad (\text{Figure A4-10}).$$

$$V^3/gv_s e = 3.23^3 / (32.2) (1.42 \times 10^{-5}) (0.0026) = 2.83 \times 10^7.$$

$$V/\sqrt{gk_s e} = 3.23 / \sqrt{(32.2) (0.01075/12) (0.0026)} = 373$$

$$V/\sqrt{\tau/\rho} = 21.6 \quad (\text{From Figure A4.8}).$$

$$\tau = v^2 \rho / (V/\sqrt{\tau/\rho})^2 = (3.23^2) 1.94 / (21.6)^2 = 0.0434 \text{ psf.}$$

$$b/d \text{ (ratio of bottom width to depth)} = 18/3.5 = 5.14$$

$$\tau_s/\tau = 1.0; \tau_b/\tau = 1.31 \quad (\text{from Figure A4-11 and A4-12}).$$

Actual Tractive Stresses:

$$\tau_s = (0.0434) (1.0) = 0.0434 \text{ psf}; \tau_b = (0.0434) (1.31) = 0.0569 \text{ psf}$$

Allowable Tractive Stresses:

$D_{50} = 0.127 \text{ mm}$; from Figure A4-13 and assuming clear water flow (curve No.3) the allowable tractive force is 0.025 psf. Both the bed and the banks of the channel are unstable.

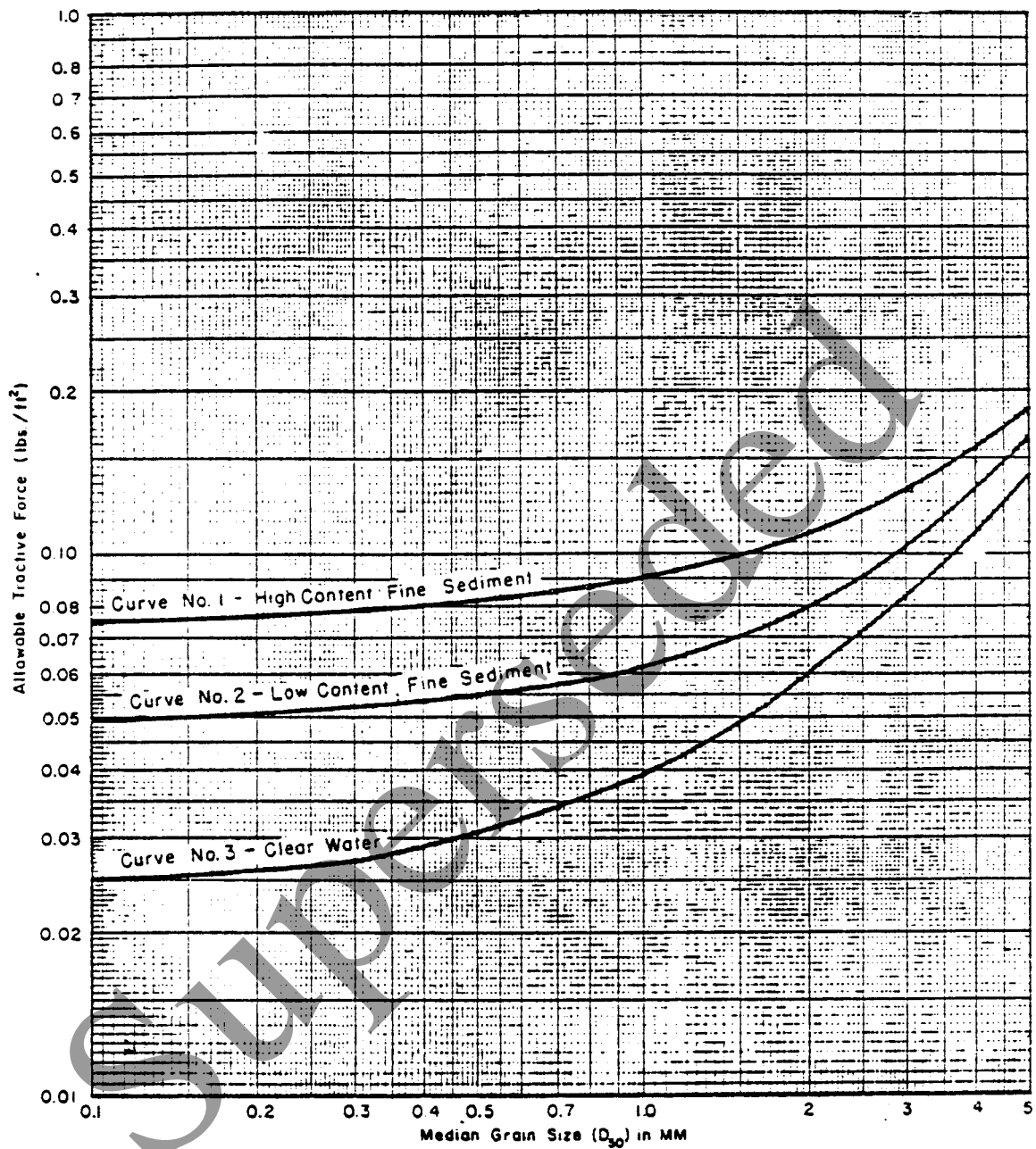

FIGURE A4-13

ALLOWABLE TRACTIVE STRESS -- NON-COHESIVE SOILS, $D_{75} < 0.25"$

REFERENCE: LANE, E. W., "DESIGN OF STABLE CHANNELS", TRANSACTIONS ASCE, VOLUME 120

GLOSSARY OF SYMBOLS

- A - alignment factor to adjust the basic velocity because of the effects of curvature of the channel.
- A - area of flow. (ft²)
- b - bottom width of a channel (feet).
- b_T - water surface width (feet).
- B - bank slope factor to adjust the basic velocity because of the effects of different bank slopes.
- C - sediment concentration in parts per million by weight.
- C₁, C₂, C₃, C₄, C₅ - coefficients used to determine channel proportions and slope when using the modified regime equations.
- C_e - Density factor to adjust the basic velocity because of variations in the density of soil materials in the channel boundary.
- C_m - cohesion intercept at natural moisture (psf).
- d - depth of flow (feet).
- d_c - critical depth of flow (feet).
- d_m - mean depth of flow (feet).
- D - depth factor to adjust basic velocity because of the effects of the depth flow.
- D_s - the particle diameter of which s% of the sample is smaller.
- F - frequency factor to adjust the basic velocity because of the effect of infrequent flood flows.
- F - Froude number =
$$\frac{v}{\sqrt{gd_m}}$$
- g - acceleration due to gravity (fps²).
- G - specific gravity.
- H_c - depth of tension crack (feet).
- k_s - characteristic length of roughness element, for granular material; k_s = D₆₅ size in feet.
- K - coefficient modifying tractive force for gravitational forces on coarse, noncohesive materials on channel sides.

- n - Manning's coefficient.
- n_t - Manning's coefficient for roughness of soil grains.
- P - wetted perimeter.
- PI - Plasticity index.
- q_u - unconfined compressive strength.
- Q - discharge (cfs).
- Q_s - Sediment transport rate (tons/day)
- R - hydraulic radius - feet.
- R_c - radius of curvature of central section of compound curve.
- R_t - hydraulic radius associated with grain roughness of the soil.
- s_o - slope of channel bottom.
- s_c - critical slope.
- s_e - energy gradient
- s_t - rate of friction head loss because of tractive stress acting on bed and side materials.
- V - average velocity (fps).
- V_a - allowable velocity (fps).
- V_b - basic velocity (fps).
- V_c - critical velocity (fps).
- W_T - top width of flow - ft.
- x - factor describing effect of ratio $\frac{k_s}{d}$ on flow resistance.
- z - cotangent of side slope angle.
- T - factor to correct allowable tractive force for materials with $D_{75} > 0.25"$ for unit weights different than 160 pcf.
- γ - unit weight of water (pcf).
- γ_d - dry unit weight (pcf).
- γ_m - moist unit weight (pcf).

- unit weight of particles larger than 0.25" (pcf).
- unit weight of water (62.4 pcf).
- thickness of laminar sublayer = $\frac{11.6v}{9R_t s_e}$
- angle of shearing resistance.
- m - angle of shearing resistance at natural moisture content.
- r - angle of repose of coarse noncohesive materials.
- kinematic viscosity of water (ft²/sec).
- p - water density (lb-sec²/ft⁴).
- reference tractive stress (psf).
- tractive stress in an infinitely wide channel (psf).
- b - maximum tractive stress on the channel bed (psf).
- s - maximum tractive stress on the channel sides (psf).
- bc - maximum tractive stress on the bed in a curved reach (psf).
- sc - maximum tractive stress on the sides in a curved reach (psf).
- Lb - allowable tractive stress along the bed. (psf)
- Ls - allowable tractive stress along the sides (psf).

SUPPLEMENT A

Method for Estimating Manning's n

This supplement describes a method for estimating the roughness coefficient "n" for use in hydraulic computations associated with natural streams, floodways and similar streams. The procedure proposed applies to the estimation of n in Manning's formula. This formula is now widely used, it is simpler to apply than other widely recognized formulas and has been shown to be reliable.

Manning's formula is empirical. The roughness coefficient n is used to quantitatively express the degree of retardation of flow. The value of n indicates not only the roughness of the sides and bottom of the channel, but also other types of irregularities of the channel and profile. In short, n is used to indicate the net effect of all factors causing retardation of flow in a reach of channel under consideration.

There seems to have developed a tendency to regard the selection of n for natural channels as either an arbitrary or an intuitive process. This probably results from the rather cursory treatment of the roughness coefficient in most of the more widely used hydraulic textbooks and handbooks. The fact is that the estimation of n requires the exercise of critical judgment in the evaluation of the surfaces of the channel sides and bottom; variations in shape and size of cross sections; obstructions; vegetation; and meandering of the channel.

The need for realistic estimates of n justifies the adoption of a systematic procedure for making the estimates.

Procedure for estimating n. The general procedure for estimating n involves; first, the selection of a basic value of n for a straight, uniform, smooth channel in the natural materials involved; then, through critical consideration of the factors listed above, the selection of a modifying value associated with each factor. The modifying values are added to the basic value to obtain n for the channel under consideration.

In the selection of the modifying values associated with the 5 primary factors, it is important that each factor be examined and considered independently. In considering each factor, it should be kept in mind that represents a quantitative expression of retardation of flow. Turbulence of flow can, in a sense, be visualized as a measure or indicator of retardance. Therefore, in each case, more critical judgment may be exercised if it is recognized that as conditions associated with any factor change so as to induce greater turbulence, there should be an increase in the modifying value. A discussion and tabulated guide to the selection of modifying values for each factor is given under the following procedural steps.

1st step. Selection of basic n value. This step requires the selection of a basic n value for a straight, uniform, smooth channel in the natural materials involved. The selection involves consideration of what may be regarded as a hypothetical channel. The conditions of straight alignment, uniform cross section, and smooth side and bottom surfaces without vegetation should be kept in mind. Thus, the basic n will be visualized as varying only with the materials forming the sides and bottom of the channel. The minimum values of n shown by reported test results for the best channels in earth are in the range from 0.016 to 0.018. Practical limitations associated with maintaining smooth and uniform channels in earth for any appreciable period indicated that 0.02 is a realistic basic n. The basic n, as it is intended for use in this procedure, for natural or excavated channels, may be selected from the table below. Where the bottom and sides of a channel are of different materials, this fact may be recognized in selecting the basic n.

<u>CHARACTER OF CHANNEL</u>	<u>BASIC n</u>
Channels in earth	0.02
Channels cut into rock	0.025
Channels in fine gravel	0.024
Channels in coarse gravel	0.028

2nd step. Selection of modifying value for surface irregularity. The selection is to be based on the degree of roughness or irregularity of the surfaces of channel sides and bottom. Consider the actual surface irregularity: first, in relation to the degree of surface smoothness obtainable with the natural materials involved, and second, in relation to the depths of flow under consideration. Actual surface irregularity comparable to the best surface to be expected of the natural materials involved calls for a modifying value of zero. Higher degrees of irregularity induce turbulence and call for increased modifying values. The table below may be used as a guide to the selection.

<u>DEGREE OF IRREGULARITY</u>	<u>SURFACES COMPARABLE TO</u>	<u>MODIFYING VALUE</u>
Smooth	The best obtainable for the materials involved.	0.000
Minor	Good dredge channels; slightly eroded or scoured side slopes of canals or drainage channels.	0.005
Moderate	Fair to poor dredged channels; moderately sloughed or eroded side slopes of canals or drainage channels.	0.010

Severe

Badly sloughed banks of natural channels; badly eroded or sloughed sides of canals or drainage channels; unshaped, jagged and irregular surfaces of channels excavated in rock.

0.020

3rd step. Selection of modifying value for variations in shape and size of cross sections. In considering changes in size of cross sections, judge the approximate magnitude of increase and decrease in successive cross sections as compared to the average. Changes of considerable magnitude, if they are gradual and uniform, do not cause significant turbulence. The greater turbulence is associated with alternating large and small sections where the changes are abrupt. The degree of effect of size changes may be best visualized by considering it as depending primarily on the frequency with which large and small sections alternate, and secondarily on the magnitude of the changes.

In the case of shape variations, consider the degree to which the changes cause the greatest depth of flow to move from side to side of the channel. Shape changes causing the greatest turbulence are those for which shifts of the main flow from side to side occur in distances short enough to produce eddies and upstream currents in the shallower portions of those sections where the maximum depth of flow is near either side. Selection of modifying values may be based on the following guide:

<u>CHARACTER OR VARIATIONS IN SIZE AND SHAPE OF CROSS SECTIONS</u>	<u>MODIFYING VALUE</u>
Changes in size or shape occurring gradually	0.000
Large and small sections alternating occasionally or shape changes causing occasional shifting of main flow from side to side	0.005
Large and small sections alternating frequently or shape changes causing frequent shifting of main flow from side to side	0.010 to 0.015

4th step. Selection of modifying value for obstructions. The selection is to be based on the presence and characteristics of obstructions such as debris deposits, stumps, exposed roots, boulders and fallen and lodged logs. Care should be taken that conditions considered in other steps are not re-evaluated or double-counted by this step.

In judging the relative effect of obstructions, consider: the degree to which the obstructions occupy or reduce the average cross sectional area at various stages; the character of obstructions (sharp-edged or angular objects induce greater turbulence than curved, smooth-surfaced objects); the position and spacing of obstructions transversely and longitudinally in the reach under consideration. The following table may be used as a guide to the selection.

<u>RELATIVE EFFECT OF OBSTRUCTIONS</u>	<u>MODIFYING VALUE</u>
Negligible	0.000
Minor	0.010 to 0.015
Appreciable	0.020 to 0.030
Severe	0.040 to 0.060

5th step. Selection of modifying value for vegetation. The retarding effect of vegetation is probably due primarily to the turbulence induced as the water flows around and between the limbs, stems and foliage, and secondarily to reduction in cross section. As depth and velocity increase, the force of the flowing water tends to bend the vegetation. Therefore, the ability of vegetation to cause turbulence is partly related to its resistance to bending force. Furthermore, the amount and character of foliage; that is, the growing season condition versus dormant season condition is important. In judging the retarding effect of vegetation, critical consideration should be given to the following: the height in relation to depth of flow; the capacity to resist bending; the degree to which the cross section is occupied or blocked out; the transverse and longitudinal distribution of vegetation of different types, densities and heights in the reach under consideration. The following table may be used as a guide to the selection:

<u>VEGETATION AND FLOW CONDITIONS COMPARABLE TO:</u>	<u>DEGREE OF EFFECT ON n</u>	<u>RANGE IN MODIFYING VALUE</u>
--	---	---------------------------------

Dense growths of flexible turfgrasses or weeds, of which Bermuda and bluegrasses are examples, where the average depth of flow is 2 to 3 times the height of vegetation.

Low

0.005 to 0.010

Supple seedling tree switches such as willow, cottonwood or salt cedar where the average depth of flow is 3 to 4 times the height of the vegetation.

Turf grasses where the average depth of flow is 1 to 2 times the height of vegetation

Stemmy grasses, weeds or tree seedlings with moderate cover where the average depth of flow is 2 to 3 times the height of vegetation Medium 0.010 to 0.025

Brushy growths, moderately dense, similar to willows 1 to 2 years old, dormant season, along side slopes of channel with no significant vegetation along the channel bottom, where the hydraulic radius is greater than 2 feet.

Turf grasses where the average depth of flow is about equal to the height of vegetation.

Dormant season, willow or cottonwood trees 8 to 10 years old, intergrown with some weeds and brush, none of the vegetation in foliage, where the hydraulic radius is greater than 2 feet. High 0.025 to 0.050

Growing season, bushy willows about 1 year old intergrown with some weeds in full foilage along side slopes, no significant vegetation along channel bottom, where hydraulic radius is greater than 2 feet.

Turf grasses where the average depth of flow is less than one half the height of vegetation.

Growing season, bushy willows about 1 year old, intergrown with weeds in full foliage along side slopes; dense growth of cattails along channel bottom; any value of hydraulic radius up to 10 to 15 feet. Very High 0.050 to 0.100

Growing season; trees intergrown with weeds and brush, all in full foliage, any value of hydraulic radius up to 10 to 15 feet.

6th step. Determination of the modifying value for meandering of channel. The modifying value for meandering may be estimated as follows: Add the basic n for Step 1 and the modifying values of Step 2 through 5 to obtain the subtotal of n_s .

Let l_s = the straight length of the reach under consideration.

l_m = the meander length of the channel in the reach.

Compute modifying value for meandering in accordance with the following table:

Ratio (l_m/l_s)	Degree of meandering	Modifying value
1.0 to 1.2	Minor	0.000
1.2 to 1.5	Appreciable	0.15 n_s
1.5 and greater	Severe	0.30 n_s

Where lengths for computing the approximate value of l_m/l_s are not readily obtainable, the degree of meandering can usually be judged reasonably well.

7th step. Computation of n for the reach. The value of n for the reach is obtained by adding the values determined in Steps 1 through 6. An illustration of the estimation of n is given in Example 1.

Example 1. Estimation of n for a reach.

This example is based on a case where n has been determined so that comparison between the estimated and actual n can be shown.

Channel: Camp Creek dredged channel near Seymour, Illinois; see USDA Technical Bullentin No 129, Plate 29-C for photograph and Table 9, page 86, for data.

Description: Course straight; 661 feet long. Cross section, very little variation in shape; variation in size moderate, but changes not abrupt. Side slopes fairly regular, bottom uneven and irregular. Soil, lower part yellowish gray clay; upper part, light gray silty clay loam. Condition, side slopes covered with heavy growth of poplar trees 2 to 3 inches in diameter, large willows and climbing vines; thick growth of water weed on bottom; summer condition with vegetation in full foliage.

Average cross section approximates a trapezoid with side slopes about 1.5 to 1 and bottom width about 10 feet. At bankfull stage, average depth and surface width are about 8.5 and 40 feet respectively.

<u>STEP</u>	<u>REMARKS</u>	<u>MODIFYING VALUES</u>
1	Soil materials indicate minimum basic n.	0.02
2	Description indicates moderate irregularity.	0.01
3	Changes in size and shape judged insignificant.	0.00
4	No obstructions indicated.	0.00
5	Description indicates very high effect of vegetation.	0.08
6	Reach described as straight.	<u>0.00</u>
	Total estimated n	0.11

USDA Technical Bulletin No. 129, Table 9, page 96, give the following determined values for NJDOT for this channel: for average depth of 4.6 feet $n = 0.095$; for average depth of 7.3 feet $n = 0.104$.

Superseded

Appendix A-5

Modified Rational Method

The Soil Conservation Service Technical Release No. 55, (TR-55), Urban Hydrology for Small Watersheds, methodology can determine peak flows from areas of up to five (5) square miles, provide a hydrograph for times of concentration of up to 2 hours, and estimate the required storage for a specified outflow. However, there is another method which can estimate peak flows and the required storage. For small drainage areas up to one-half square mile, the Rational Method ($Q=cia$, where Q is the runoff in cfs, i is the intensity of rainfall in inches/hour for the time of concentration of the drainage area, a is the area in acres, and c is a dimensionless runoff coefficient) can determine the peak flow rate only. The Modified Rational Method (MRM) as discussed in the American Public Works Association's Special Report 43, can give an approximate storage volume and triangular and trapezoidal hydrographs. This method is applicable for uniform areas up to twenty (20) acres.

THEORY

The area under a hydrograph equals the volume of runoff. For the Modified Rational Method, this area is equal to the peak discharge rate times the duration of the storm. A uniform rainfall intensity for the entire rainfall period is assumed here. This is highly unlikely.

The MRM recommends that a coefficient be used in order to account for the antecedent moisture conditions of storms greater than those with a twenty-five (25) year recurrence intensity ($Q=ca \times c \times i \times a$). This attempts to predict a more realistic runoff volume which is characteristic of higher frequency storms. The maximum product of $ca \times c$ cannot be greater than one.

Recommended Antecedent Precipitation Factors for the Rational Method

<u>Recurrence Interval (years)</u>	<u>ca</u>
2 to 10	1.0
25	1.1
50	1.2
100	1.25

The time of concentration (t_c), which is the time of travel from the most remote point (in time of flow), determines the largest peak discharge. Therefore, there are two possible approximate hydrographs that can be used for runoff and storage requirements.

FIRST CASE If the rainfall duration is greater than the t_c , then the approximate hydrograph is a trapezoid.

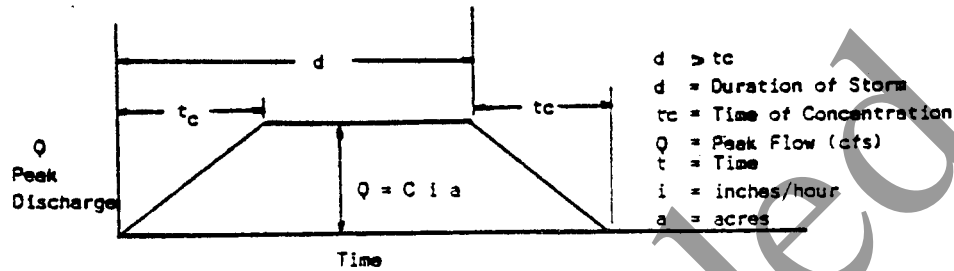

SECOND CASE If the rainfall duration is equal to the time of concentration (assuming the t_c is the same as in the first case), then the approximate hydrograph is a triangle.

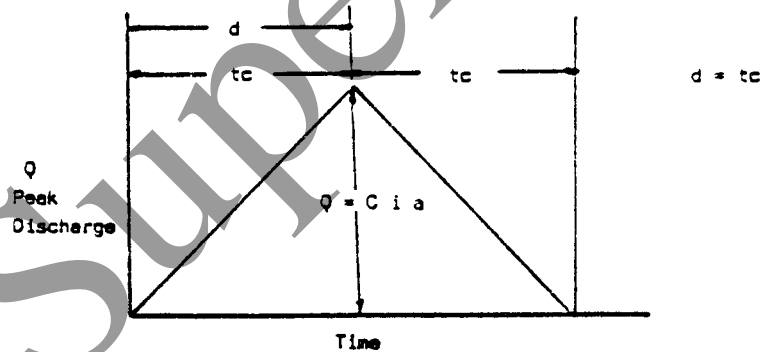

To find the required volume, the MRM uses a trial method to find the critical storage for a given drainage area. For instance, the peak rate for a 25 year storm is the product of the runoff coefficient times the drainage area in acres times the intensity of a 25 year storm for a given time of concentration. However, the critical storage volume may be that of a different duration.

There are three steps in the MRM. The first step is to collect the physical data for the drainage area. This is the drainage area, the time of concentration, the runoff coefficient, and the allowable release rate. The second step is to obtain the proper recurrence interval for the design storm and the intensity-duration relationship for the design frequency. Then calculate a series of peak flows and runoff volumes beginning with the time of concentration of the drainage area and for increased storm durations. The third step is to compute the release volume and the required storage until the maximum or critical storage is found.

EXAMPLE

First Step. A site to be developed has a ground cover of forest with light underbrush. The soil type for the site is Evesboro soil (sand), hydrologic soil group A. The predeveloped site drains into two drainage areas. The southern portion consists of 6.39 acres. The northern portion consists of 8.07 acres. In order to minimize the effect of increased storm water runoff downstream, possibly resulting in soil erosion and sedimentation damage, an onsite detention basin is proposed for the developed condition. Grading of the site will cause the southern drainage area to increase to 11.88 acres. Since the NJDEP curves do not contain the 2 year frequency, the intensity-duration curves for New York City were used in the analysis. A summary of the times of concentration and drainage areas is as follows:

Southern Portion

Storm (years)	Predeveloped Condition					Postdeveloped Condition				
	Acres	tc	C	i	Q	Acres	tc	C	i	Q
2	8.07	0.35	0.22	2.5	4.4	11.88	0.25	0.7	2.9	24
10	8.07	0.35	0.22	4.0	7.1	11.88	0.25	0.7	4.7	39

where tc is hours, i is inch/hour, and Q is cfs .

Second step. Stability is demonstrated offsite by analyzing the velocity for storm water runoff for the two and ten year storms over a defined waterway. These frequencies are chosen because of their high probability of occurrence. Outflow from a detention basin must meet the Conduit Outlet Protection (2-14), Slope Protection (2-5), and Channel Stabilization (2-6) standards. Stability to the point of discharge to a stream or body of water should be shown in all cases. In this example it was assumed that it was not possible to obtain a drainage easement to accomplish this and therefore the discharge from the proposed outlet at the detention basin must match the predevelopment peak flow at that point. The allowable release rate is therefore the predevelopment peak flow for the 2 and 10 year frequency storms at the proposed point of discharge.

$$\begin{aligned}t_c &= 10 \text{ minutes} \\C &= 0.18 \text{ for the predeveloped drainage area} \\&\quad \text{at that point of future discharge} \\a &= 0.93 \text{ acres (not 8.07 acres)} \\i &= 5.5 \text{ inches per hour (10 year frequency)} \\ \\Q &= C \times i \times a \\&= 0.18 \times 5.5 \times 0.93 \\&= 0.92 \text{ cfs predevelopment peak at the} \\&\quad \text{point of discharge which is the} \\&\quad \text{allowable release rate.}\end{aligned}$$

Third step. Construct a series of hydrographs for each selected duration of the storm as shown in figure A5.1, Modified Rational Method Hydrographs. The estimated critical storage for this site is 88,858 cubic feet. Since the inflow volume must equal the outflow volume of 98,794 cubic feet, the time to the end of the release rate is 30.3. To reach zero outflow approximately 0.5 hours must be added so the total dewatering time will be about 30.3 hours. The outflow hydrograph reaches maximum flow at the intersection with the falling limb of the hydrograph resulting from a storm with a duration equal to the time of concentration.

Table A5.2

Storage-Duration Values

Duration of Storm (hr) (1)	Intensity i (in/hr) (2)	Peak Flow Q (cfs) (3)	Volume of Runoff (cuft) (4)	Release Flow Volume (cuft) (5)	Required Storage Volume (cuft) (6)
0.25	4.8	39.9	35,925	828	35,097
0.50	3.4	28.3	50,894	1,656	49,238
0.75	2.7	22.5	60,624	2,484	58,140
1.00	2.3	19.1	68,856	3,312	65,544
1.50	1.7	14.1	76,341	4,968	71,373
2.00	1.4	11.6	83,825	6,624	77,201
3.00	1.1	9.1	98,794	9,936	88,858 *
3.50	0.9	7.5	94,303	11,592	82,711

Column (3) Peak Flow = $Q = c i a$
 example : $0.7 \times 4.8 \times 11.88 = 39.9$ cfs

Column (4) Runoff Volume = Q (col 3) X Duration of Storm
 (col 1) X 3600
 example : 39.9 cfs X 0.25 hrs X $3600 = 35,925$ cuft

Column (5) Release Volume = 0.92 cfs X Duration of Storm
 (col 1) X 3600
 example : $0.92 \times 0.25 \times 3600 = 828$ cuft

Column (6) Required Storage = Runoff Volume (col 4) - Release
 Volume (col 5)
 example : $35,925 - 828 = 35,097$

10 YEAR RECURRING INTERNAL HYDROGRAPH
 FOR RAINFALL PERIOD OF VARIOUS DURATION

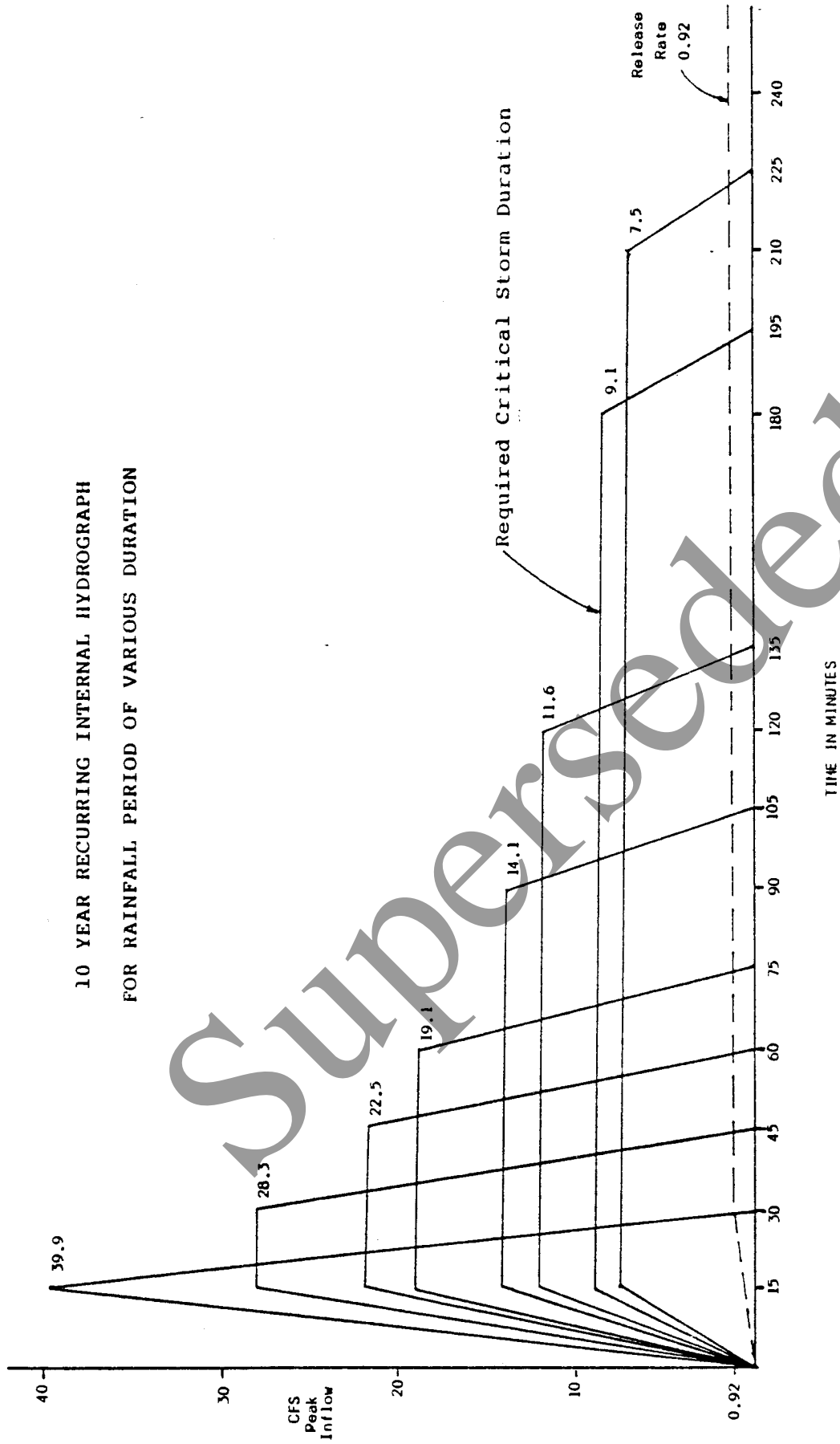

Figure A5.1

APPENDIX A6

REFERENCES

The following references are cited in the standards:

1. Engineering Field Manual, Washington, D.C., Soil Conservation Service, U. S. Department of Agriculture, 1979.
2. Tentative Design Procedures for Riprap - Lined Channels, National Cooperative Highway Research Program Report 108, Washington, D. C., Highway Research Board, National Research Council, 1970.
3. Predicting Rainfall - Erosion Losses, A Guide to Conservation Planning, Agricultural Handbook No. 537, Washington, D. C., Science and Education Administration, U. S. Department of Agriculture, December 1978.
4. Section 4, Hydrology, National Engineering Handbook, Washington, D.C., Soil Conservation Service, U. S. Department of Agriculture, 1971.
5. Maccaferri Gabions Technical Handbook, New York, N. Y., Maccaferri Gabions of America, Inc.
6. Chow, Ven T., Open Channel Hydraulics, New York, N. Y., McGraw-Hill, 1959.
7. Roughness Characteristics of Natural Channels, Water-Supply Paper 1849. Washington, D. C., U. S. Geological Survey, 1967.
8. Design of Open Channels, Technical Release No. 25, Washington, D. C., Soil Conservation Service, U. S. Department of Agriculture, October 1977.
9. Urban Hydrology for Watersheds, Technical Release No. 55, Washington, D. C., Soil Conservation Service, U. S. Department of Agriculture, 1986.
10. Standard Specifications for Road and Bridge Construction, Trenton, N.J., New Jersey Department of Transportation 1983 with revisions.
11. Standards for Soil Erosion and Sediment Control, N.J. Association of Conservation Districts, 1987.

OTHER REFERENCES

The following references provide additional information on subjects covered in the Standards:

Duell, Robert W., Highway Vegetation, Bulletin 822, New Brunswick, N. J., Rutgers College of Agriculture and Environmental Science.

Duell, R. W., and R. M. Schmit, Better Grasses for Roadsides, Transportation Research Record No. 551, National Academy of Science, 1975, pp. 30-41.

Fletcher, B. P. and Grace, J. S., Jr., Practical Guidance for Estimating and Controlling Erosion at Culvert Outlets, 1972, Corps of Engineers Research, Report H-72-5, Waterways Experiment Station, Vicksburg, Mississippi.

Funk, C. R., R. E. Engel, R. W. Duell, and W. K. Dickson, "Kentucky Bluegrass for New Jersey Turf", Rutgers Turf Grass Proceedings. New Brunswick, N. J., Soils and Crops Offset Series No. 9, 1978, pp. 120-142.

Guideline Specifications to Sodding. Hastings, Nebraska, American Sod Producers Association, Inc.

Lacey, Donald B., Ground Covers - Carpets for Outdoor Living, Extension Service Publication 351-A. New Brunswick, N. J., Rutgers College of Agriculture and Environmental Science, 1970.

Nathan, Kurt, R. B. Alderfer, S. A. Decter, R. N. Hanna, M. E. Singley, K. S. Werkman, and K. T. Wilson, Water Control Guide for Suburban and Rural Residential New Jersey, Circular 605, New Brunswick, N. J., Rutgers College of Agriculture and Environmental Science, 1965.

O'Knefski, R. C., C. R. Funk, R. E. Engel and R. W. Duell, Lawn Grasses for New Jersey, Leaflet 509, New Brunswick, N. J., Rutgers College of Agriculture and Environmental Science, 1975.

O'Knefski, R. C., C. R. Funk, R. E. Engel and R. W. Duell, "Lawn Grasses for New Jersey," Rutgers Turf Grass Proceedings, New Brunswick, N. J., Soils and Crops Offset Series No. 6, 1975, pp. 89-94.

Poertner, H.G., Modified Rational Method, Special Report 43, American Public Works Association, Chicago, Illinois, 1974

Schmit, R. N., C. R. Funk, and R. W. Duell, "Morphology and Behavior of the Fine Fescues," Rutgers Turf Grass Proceedings, New Brunswick, N. J., Soils and Crops Offset Series No. 5, 1974, pp. 4-8.

Simons, Daryl B., Chen, Ung H., Swenson, Lawrence J., Hydraulic Test to Develop Criteria for the Use of Reno Matters, Civil Engineering Department, Engineering and Research Center, Colorado State University, Fort Collins, Colorado, March 1984.

Tedrow, J. C. F., New Jersey Soils, Circular 601, New Brunswick, N. J., Rutgers College of Agriculture and Environmental Science.

The following references are cited in the Appendices:

- a1. Fortier, S. F. and Scobey, F. C., Permissible Canal Velocities, American Society of Civil Engineering Transactions, Vol. 89, pp. 940-956.
- a2. Lane, E. W., Progress Report on Results of Studies on Design of Stable Channels, Hydraulic Laboratory Report No. Hyd-352, U. S. Bureau of Reclamation, June 1952.
- a3. Standards for Permissible Non-Eroding Velocities, Bureau of the Methodology of the Hydro-Energo Plan; Gidrotekhnicheskoye Stroitel'stvo, Obedinennoye Nauchno-Tekhnicheskoye Ispytatel'stvo., Moscow, USSR, May 1936.
- a4. Einstein, H. A., The Bedload Function for Sediment Transportation in Open Channel Flow, USDA Technical Bulletin No. 1026, September 1950.
- a5. Vanoni, V. A. and Brooks, N. H., Laboratory Studies of the Roughness and Suspended Load of Alluvial Streams, U. S. Army Corps of Engineers, Missouri River Division Sediment Series No. 11, December 1957.
- a6. Standards for Soil Erosion and Sediment Control, N.J., Association of Soil Conservation Districts, 1987.

Superseded

APPENDIX A7

G L O S S A R Y

Acre-feet - An engineering term used to denote a volume 1 acre in area and 1 foot in depth.

Aggrade - The alteration of a channel caused by the deposition of sediment.

Anti-seep Collar - A device constructed around a pipe or other conduit placed through a dam, dike, or levee for the purpose of reducing seepage losses and piping failures.

Anti-vortex Device - A facility placed at the entrance to a pipe conduit structure such as a drop inlet spillway or hood inlet spillway to prevent air from entering the structure when the pipe is flowing full.

Barrel - See conduit.

Borrow Area - A source of earth fill materials used in the construction of embankments or other earth fill structures.

Bottomlands - A term often used to define lowlands adjacent to streams (flood plains in rural areas).

Box Inlet Drop Spillway - A form of principal spillway.

Cantilever Outlet - A discharge pipe extending beyond its support.

Cascades or Bedrock - Section of stream without pools, consisting primarily of bedrock with little rubble, gravel, or other such material present. Current usually more swift than in riffles.

Channel - A natural stream that conveys water; a depth or channel excavated for the flow of water.

Chute Spillway - A form of principal spillway.

Conduit - A closed facility used for the conveyance of water.

Cover Crop - A crop grown primarily for the purpose of protecting soil between periods of permanent vegetative cover.

Cradle - A device usually concrete, used to support a pipe conduit or barrel.

Cutoff Trench - A long, narrow excavation constructed along the center line of a dam, dike, levee or embankment and filled with relatively impervious material intended to reduce seepage of water through porous strata.

Degrade - The alteration of a channel caused by the erosion and scour of the channel bottom.

Design Highwater - The elevation of the water surface as determined by the flow conditions of the design floods.

Design Life - The period of time for which a facility is expected to perform its intended function.

Diversion - A channel with or without a supporting ridge on the lower side, constructed across or at the bottom of a slope for the purpose of intercepting surface runoff.

Embankment - A man-made deposit of soil, rock or other materials used to form an impoundment.

Emergency Spillway - A vegetated earth channel used to safely convey flood discharges in excess of the capacity of the principal spillway.

Energy Dissipater - A device used to reduce the energy of flowing water.

Erosion - Detachment and movement of soil or rock fragments by water, wind, ice and gravity.

Field Capacity - The amount of water retained in a soil after it has been saturated and has drained freely. It is usually expressed as a percentage of the overdry weight of the soil. Also called field moisture capacity.

Filter Blanket - A layer of sand, gravel, or synthetic fabric designed to prevent the movement of fine-grained soils.

Filter Strip - A long, narrow vegetative planting used to retard or collect sediment for the protection of diversions, drainage basins, or other structures.

Flat - Section of stream with current too slow to be classed as riffle and too shallow to be classed as a pool. Stream bottom usually composed of sand or finer materials, with coarse rubble, boulders or bedrock occasionally evident.

Flood Plain - The relatively flat area adjoining the channel of a natural stream which has been or may be hereafter covered by flood water.

Flood Routing - Determining the changes in the rise and fall of flood water as it proceeds downstream through a valley or through a reservoir.

Flume - A device constructed to convey water on steep grades lined with erosion-resistant materials.

Freeboard - The vertical distance between the elevation of the design highwater and the top of the dam, dike, levee or diversion ridge.

Grade Stabilization Structure - A structure for the purpose of stabilizing the grade of a watercourse, thereby preventing further headcutting or lowering of the channel grade.

Grading - Any stripping, cutting, filling, stockpiling, or any combination thereof and shall include the land in its cut or filled condition.

Grassed Waterway - A natural or constructed channel, usually broad and shallow, covered with erosion-resistant vegetation, used to conduct surface water.

Hood Inlet - A pipe entrance wherein the top edge of the pipe is extended 3/4 of the diameter beyond the bottom invert cut on an angle.

Hydrograph - A graph showing for a given point on a stream or for a given point in any drainage system, the discharge, stage, velocity, or other property of water with respect to time.

Inoculant - A peat carrier impregnated with bacteria which form a symbiotic relationship enabling legumes to utilize atmospheric nitrogen. Most of our legumes require specific bacteria.

Impact Basin - A device used to dissipate the energy of flowing water. Generally constructed of concrete in the form of a depressed and partially submerged vessel and may utilize baffles to dissipate velocities.

Land - Any ground, soil or earth including marshes, swamps, drainageways and areas not permanently covered by water.

Liquid Limit - The moisture content at which the soil passes from a plastic to a liquid state. In engineering, a high liquid limit indicates that the soil has a high content of clay and a low capacity for supporting loads.

Mannings Formula - A formula used to predict the velocity of water flow in an open channel or pipeline:

$$V = \frac{1.486 r^{2/3} S^{1/2}}{n}$$

wherein "V" is the mean velocity of flow in feet per second; "r" is the hydraulic radius; "s" is the slope of the energy gradient or, for assumed uniform flow, the slope of the channel in feet per foot; and "n" is the roughness coefficient or retardance factor of the channel lining.

Mulching - The application of plant residue or other suitable materials to the land surface to conserve moisture, hold soil in place, aid in establishing plant cover and minimize temperature fluctuation.

Outlet - Point of water disposal from a stream, river, lake, tidewater, or artificial drain.

Peak Discharge - The maximum instantaneous flow from a given storm condition at a specific location.

pH - A measure of acidity or basicity, with pH 7 being neutral and pH 6.5 being a desirable degree of soil acidity. Basicity above pH 7 is rare in eastern U.S. soils.

Pipe Drop - A circular conduit used to convey water down steep grades.

Plasticity Index - The numerical difference between the liquid limit and the plastic limit; the range of moisture content within which the soil remains plastic.

Plastic Limit - The moisture content at which a soil changes from a semi-solid to a plastic state.

Plunge Pool - A device used to dissipate the energy of flowing water that may be constructed or made by the action of flowing. These facilities may be protected by various lining materials.

Pool - Section of stream deeper and usually wider than normal with appreciably slower current than immediate upstream or downstream areas and possessing adequate cover (sheer depth or physical condition) for protection of fish. Stream bottom usually a mixture of silt and coarse sand.

Preformed Scour Hole - An area at the outlet end of a storm drain, at an elevation essentially the same as the outlet invert, which has been excavated and lined with stone and which provides both vertical and lateral expansion downstream of the outlet to permit dissipation of excess kinetic energy in turbulence.

Principle Spillway - Generally constructed of permanent material and designed to regulate the normal water level, provide flood protection and/or reduce the frequency of operation of the emergency spillway.

Rational Formula - $Q=CIA$. Where "Q" is the peak discharge measured in cubic feet per second, "C" is the runoff coefficient reflecting the ratio of runoff to rainfall, "I" is the rainfall intensity for the duration of the storm measured in inches per hour, and "A" is the area of the contributing drainage area measured in acres.

Ridge - The bank or dike constructed on the downslope side of a diversion.

Riffle - Section of stream containing gravel and/or rubble, in which surface water is at least slightly turbulent and current is swift enough that the surface of the gravel and rubble is kept fairly free from sand and silt.

Riprap - Angular broken rock placed on earth surfaces, such as the face of a dam or the channel of a stream, for protection against the action of water.

Riser - The inlet portion of a drop inlet spillway that extends vertically from the pipe conduit barrel and controls the water surface.

Scour Hole - See: Preformed Scour Hole.

Sediment - Solid material, both mineral and organic, that is in suspension, is being transported, or has been moved from its site of origin by air, water, gravity or ice.

Sediment Basin - A depression formed by the construction of a barrier or dam built at suitable locations to retain rock, sand, gravel, silt or other material.

Soil - The unconsolidated mineral and organic material on the immediate surface of the earth that serves as a natural medium for the growth of land plants.

Soil Horizon - A layer of soil, approximately parallel to the surface, that has distinct characteristics produced by soil-forming processes.

Stabilized Center Section - An area in the bottom of a grassed waterway protected by stone, asphalt, concrete or other materials to prevent erosion.

Storm Frequency - An expression or measure of how often a hydrologic event of given size or magnitude should on an average be equaled or exceeded. The average should be based on a reasonable sample.

Straight Drop Spillway - A form of principal spillway.

Straw - The natural dry stem and related material threshed of its seed.

Tailwater - The depth of the receiving water at the end of the apron.

Temporary Protection - Stabilization of erodible or sediment-producing areas.

Toe Drain - A drainage system constructed in the downstream portion of an earth dam or levee to prevent excessive hydrostatic pressures.

Trash Rack - A device used to prevent debris from entering a spillway or other hydraulic structure.

Underdrains - Pipelines of tile with open joints or perforated pipe used for the collection of subsurface water.

Unified Soil Classification System - A classification system based on the identification of soils according to their particle size, gradation, plasticity index and liquid limit.

Uplift Forces - Vertical pressures acting upward on a structure, usually caused by a buoyant condition.

Vegetative Protection - Stabilization of erosive or sediment producing areas by covering the soil with:

- a. Permanent seeding, producing long-term vegetative cover,
- b. Short-term seeding, producing temporary vegetative cover, or
- c. Sodding, producing areas covered with a turf of perennial sod-forming grass.

Velocity - The rate of flow measured in feet per second.

Waterway - A natural course or constructed channel for the flow of water. See: Grassed Waterway.

Superseded