



# New HMA Products and Trends for NJDOT



# Bridge Deck Water-Proof Wearing Course (BDWC)



# Water Proof Wearing Course Mix

- Mix designed to provide a thin, rut and fatigue resistance mixture for bridge deck overlays
- Can be placed on bridge deck without vibratory rollers
- Asphalt mixture must also be “water proof” or low permeability
- “Sealing older bridge structures”



## Some of Our Problems: I-80 Bridge Deck

“ When we paved over the deck with a membrane the contractor did not expose the open joint for a few weeks. During that time it rained extensively. The 12.5H76 material is very porous. When the contractor exposed the open joint a river of water lay on the membrane and ran down the sloped deck along the open joint. Since the joint area was always wet the asphaltic joint was not able to be constructed with optimum results. They are now popping out. When we placed the asphaltic joint immediately after paving completed this condition was minimal.”



# I-80 Bridge Deck

- Problems attributed to:
  - Potentially high air voids in 12H76 mix placed on bridge deck
    - No vibration on during rolling
    - Coarse, stiff mix with most likely low asphalt



# I-80 Lab Testing

- Cores taken from Bridge Deck and brought to Rutgers for forensics and permeability testing
- Air Voids:
  - Core #2 = 10.4%
  - Core #4 = 13.7%
  - Core #5 = 13.7%
  - Core #6 = 14.2%
- Only 2 cores in good enough shape for permeability testing (#2 and #5)

# Falling Head Permeability Test

- Most commonly used for asphalt
- Can test 4 or 6" diameter cores
- Rubber membrane forced on side of samples (15 psi) to prevent side leakage



# Permeability Results of Bridge Deck Cores

- Core #2 = 0.477 ft/day
  - Tested with Membrane still attached!
- Core #5 = 3.539 ft/day

Membrane





# What to Do?

- Need an HMA mix that:
  - Can be placed thin at low air voids without vibration on bridge decks
  - Be rut resistant while being crack resistant
  - Produced and placed using typical construction practices
  - Should be able to be “fixed” or “corrected” when aging occurs under normal maintenance procedures
  - This problem not unique to NJDOT Bridge Decks!



# GWB Mixture Evaluation

- PANYNJ looking to improve performance of GWB bridge deck overlays
  - Rutting not an issue (new material should not be worse though!)
  - Longitudinal cracking in truck lane
    - Flexing in steel orthotropic decks under loading causing high tensile straining in HMA
    - High tensile stresses immediately outside truck tires
  - Ease of construction – always must keep in mind!

# Asphalt Pavement Analyzer

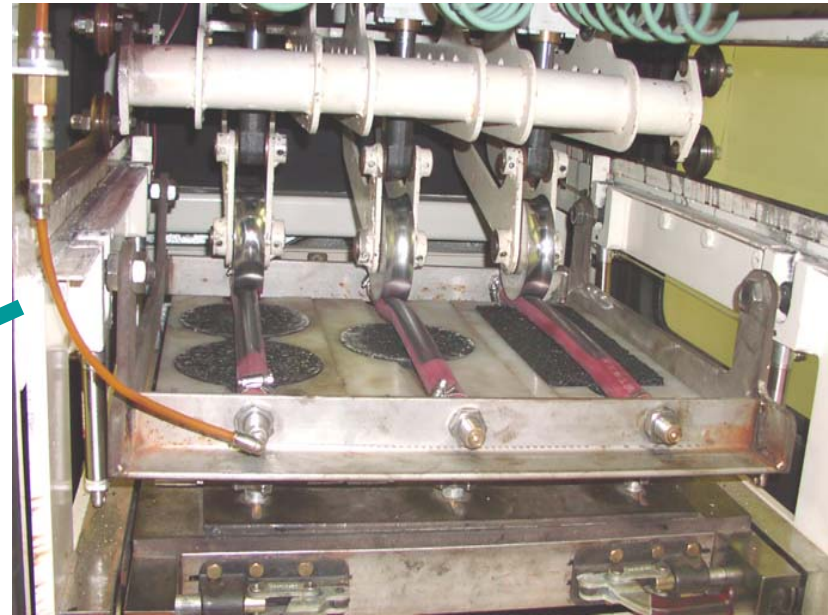

## AASHTO TP 63

- 100 lb wheel load; 100 psi hose pressure
- Tested at 64°C for 8,000 loading cycles

# Fatigue Evaluation (Vertical)



- Flexural Beam Fatigue Device, AASHTO T-321
- Tests mix's ability to withstand repeated bending which causes fatigue failure
- Data = number of loading cycles to failure (loss of stiffness)
- Run at 2000  $\mu$ -strain and 10 Hz (high deflection, fast moving vehicle)

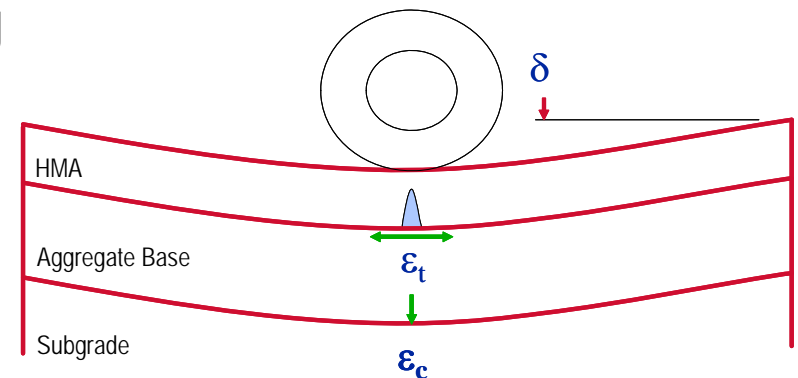

# Permeability Testing of Water-Proof Wearing Course

- Water-proof wearing course mixture was found to be “impermeable” – could not get water to flow through sample

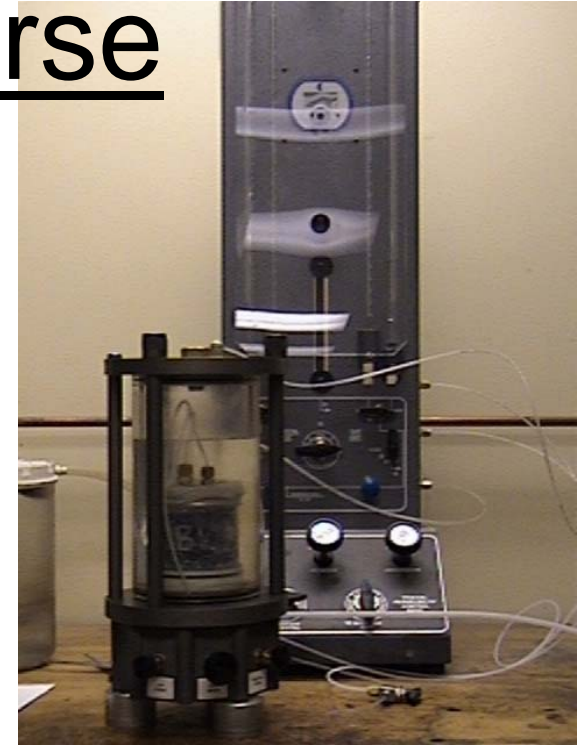

Samples cored from 6-inch diameter gyratory sample →





# Water Proof Wearing Course – Design Acceptance

1. Perform volumetric design and NJDOT verification
2. Supply Rutgers University loose mix for performance testing
3. Produce mix through plant and pave test strip off site
4. Sample during production and supply Rutgers University loose mix for performance testing

# Why Do Performance Testing?

- AE Stone's 1<sup>st</sup> (Right) and 2<sup>nd</sup> (Left) test strip
- Right lane flushed and did not set like as anticipated
- Performance testing showed poor results
- Why? Eventually found out AE Stone did not switch over proper value on tank – used wrong asphalt binder!





# 1<sup>st</sup> vs 2<sup>nd</sup> Test Strip Material

64°C Test Temp.; 100psi Hose Pressure; 100 lb Load Load

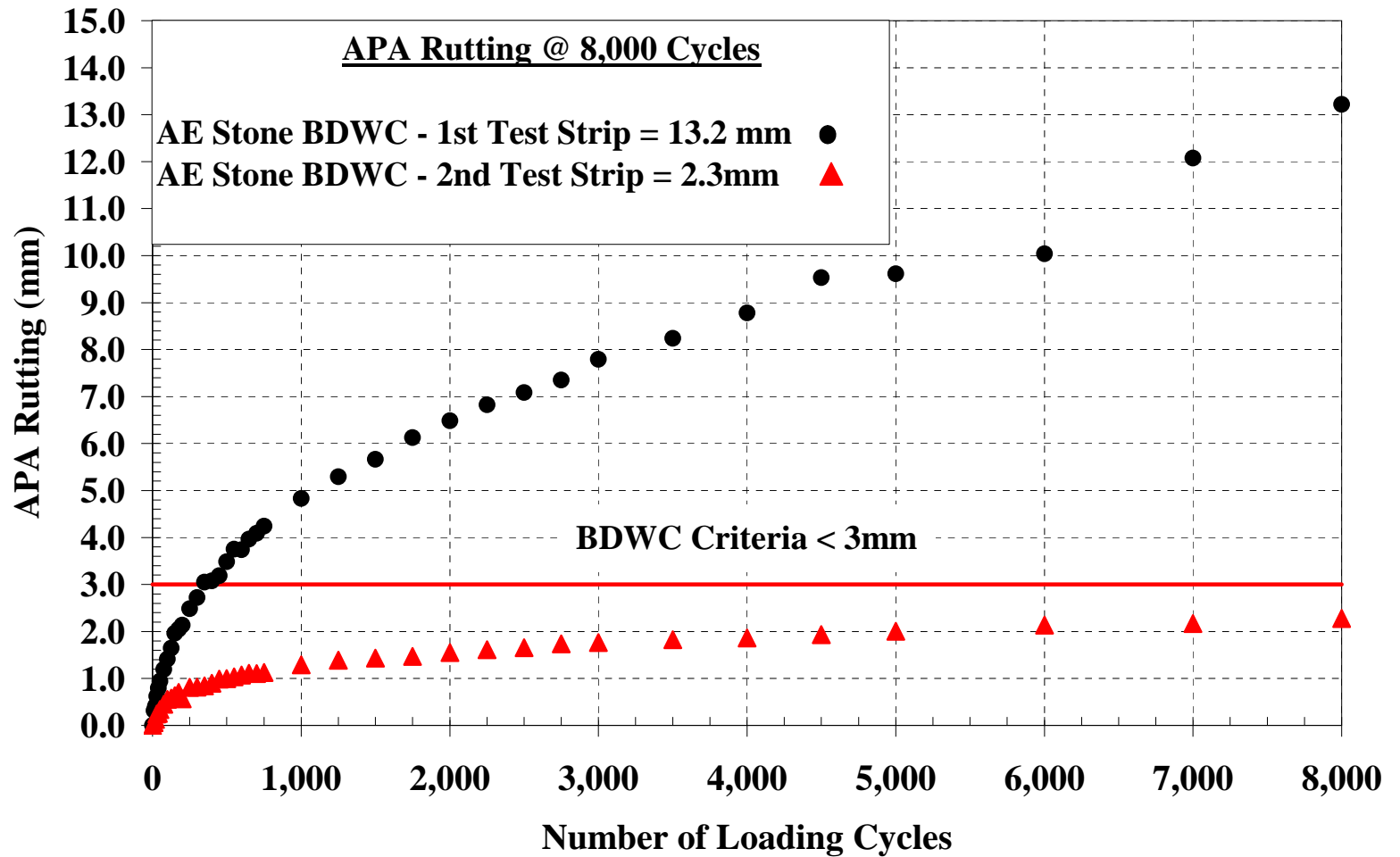





# 1<sup>st</sup> vs 2<sup>nd</sup> Test Strip Material

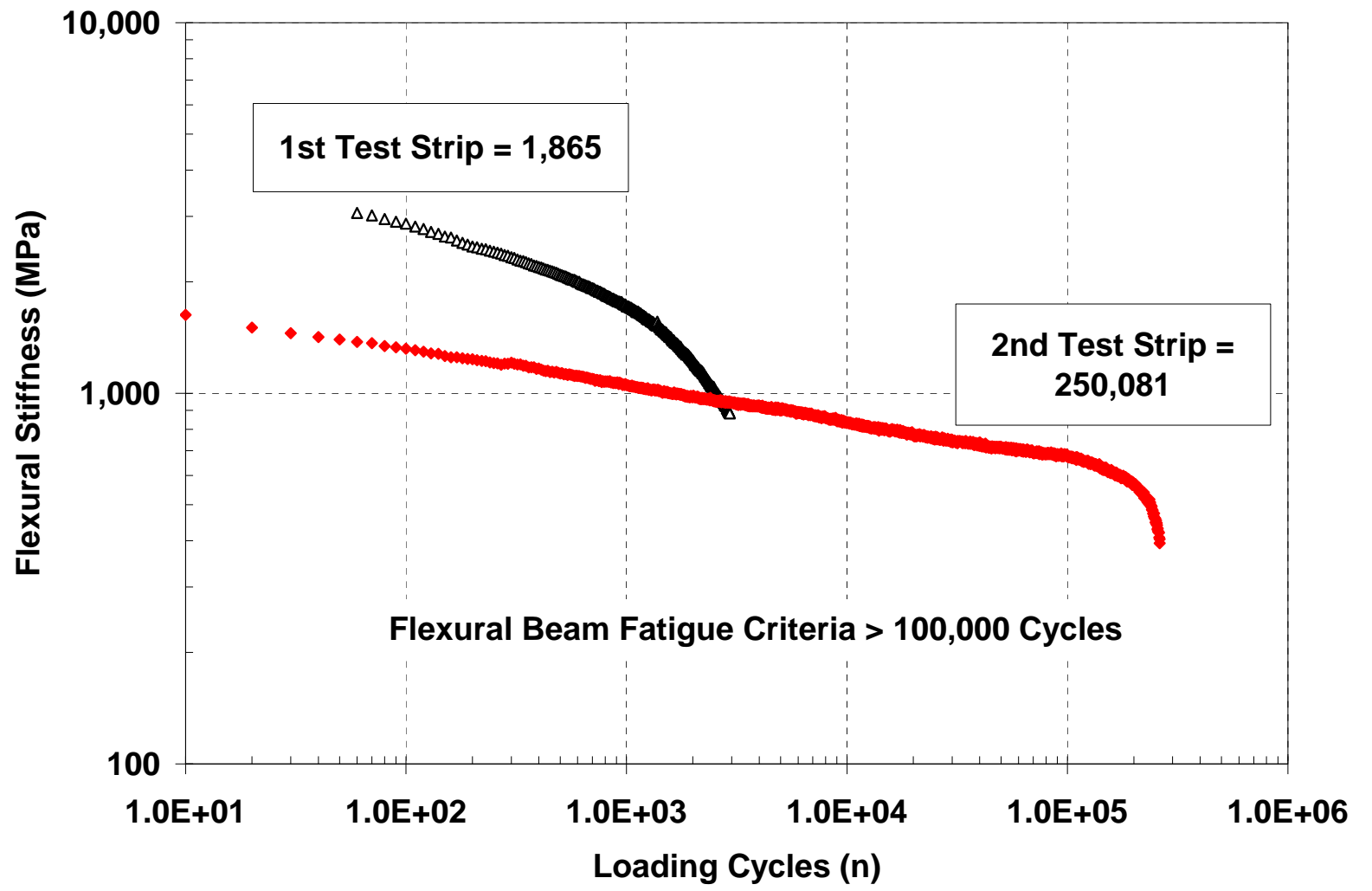

# 1<sup>st</sup> Project – Rt 87

## Absecon Inlet Bridge

- A.E. Stone produced first BDWC mix
- 1900 tons placed and compacted to a 2-inch thickness in 2 days
- Core densities all between 2 to 4% air voids



Rt 87 Absecon Inlet Bridge –  
2008 NAPA Quality in  
Construction Award Winner!  
for Non-Typical Asphalt Project





# Warm Mix Asphalt

# What is Warm Mix Asphalt





# Different WMA Types

- Viscosity Reducers – These additives significantly reduce the viscosity of the binder at mixing and compaction temperatures.
  - Sasobit and Asphaltan B
- Foamed Asphalt – Produced by introducing moisture into the asphalt binder in the mix plant.
  - Zeolite, Low Energy Asphalt (LEA), ASTEC Double Barrel Green
- Emulsions - Use of an emulsion as the asphalt binder.
  - Evotherm
- Surfactants – Chemical product that increases the lubrication between aggregate particles during movement
  - Evotherm 3G, Rediset



# Features & Benefits of WMA

- Better Workability of the Asphalt Mix Allows
  - Longer Haul Times
  - Extension of the Paving Season
  - Easier Handling of Stiff Mixes such as Polymer Modified, Rubber Asphalt Binder and high RAP Content.



# Features & Benefits of WMA

- Reduction in Production Temperatures  
Reduces Emissions
  - Reduce Blue Smoke complaints
  - Reduce Recordable Emissions
- Reduction in Production Temperatures  
Reduces Energy Consumption
  - Depending on mix it may be possible to save 10 to 20% on energy costs.
    - Lower fuel consumption; lower electricity at pumps and conveyors due to reduce viscosity



# Evotherm Test Section on I78 in NJ

Control Mix: 12M76 with 25% RAP



# I-78 Warm Mix





# Recorded Emissions – Ohio Test Trials

Stack Emissions Tests

Mix Type	SO <sub>2</sub> lb/hr	NO <sub>x</sub> lb/hr	CO lb/hr	VOC lb/hr
Conventional HMA	0.24	5.2	63.1	7.8
Evotherm WMA	0.37 (+54.2%)	5.1 (-1.9%)	50.3 (-20.2%)	20.2 (+159%)
Aspha-Min WMA	0.04 (-83.1%)	3.6 (-29.7%)	24.0 (-61.9%)	2.9 (-63.2%)
Sasobit WMA	0.04 (-83.1%)	4.1 (-21.3%)	23.2 (-63.2%)	3.8 (-50.9%)

SO<sub>2</sub> Sulfur Dioxide

NO<sub>x</sub> Nitric Oxide

CO Carbon Monoxide

VOC Volatile Organic Compound



# Recorded Emissions – Ohio Test Trials

Paver Emissions – NIOSH Method 5024 for Total Particulates (TP)

Evotherm WMA: 77% of Conventional HMA

Aspha-Min WMA: 67% of Conventional HMA

Sasobit WMA: 74% of Conventional HMA



# NJDOT Warm Mix Asphalt

- Being used under “Pilot Project” conditions – still experimental
- Three field projects conducted to date
- Looking at 2 to 3 more this season (asphalt rubber applications)



# High Performance Thin Overlay

HPTO



# High Performance Thin-Overlay (HPTO)

- Focused Applications
  - Preventative Maintenance – NJDOT
    - Placed after signs of initial surface distress
    - Also potential use of “Shim” course on PCC prior to Wearing Course
  - Pavement Overlay – Locals/Municipalities
    - Place immediately on surface of pavements showing signs of surface distress with or without milling
      - **Low severity wheelpath alligator cracking (base issues)**
      - **Surface cracking with minimal rutting**

# Potential Areas of Application

Minimal Rutting – low to moderate  
surface cracking  
No Full Depth Cracking!



Low Severity Wheelpath

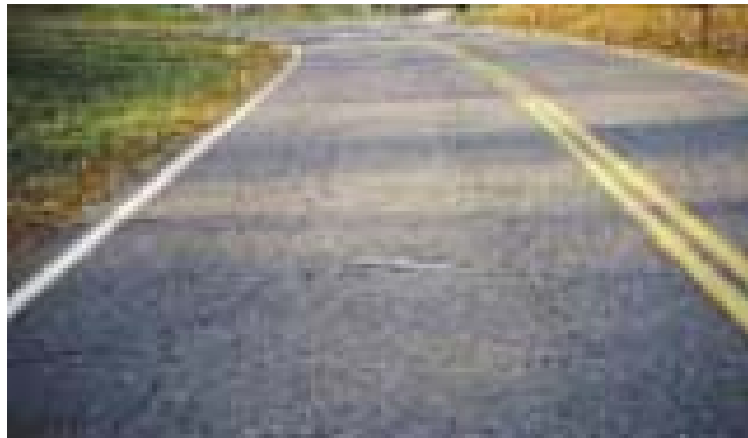

Low to Mod. Longitudinal  
Cracking



Low to Mod. Transverse  
Cracking





# Direct Overlay – No Milling

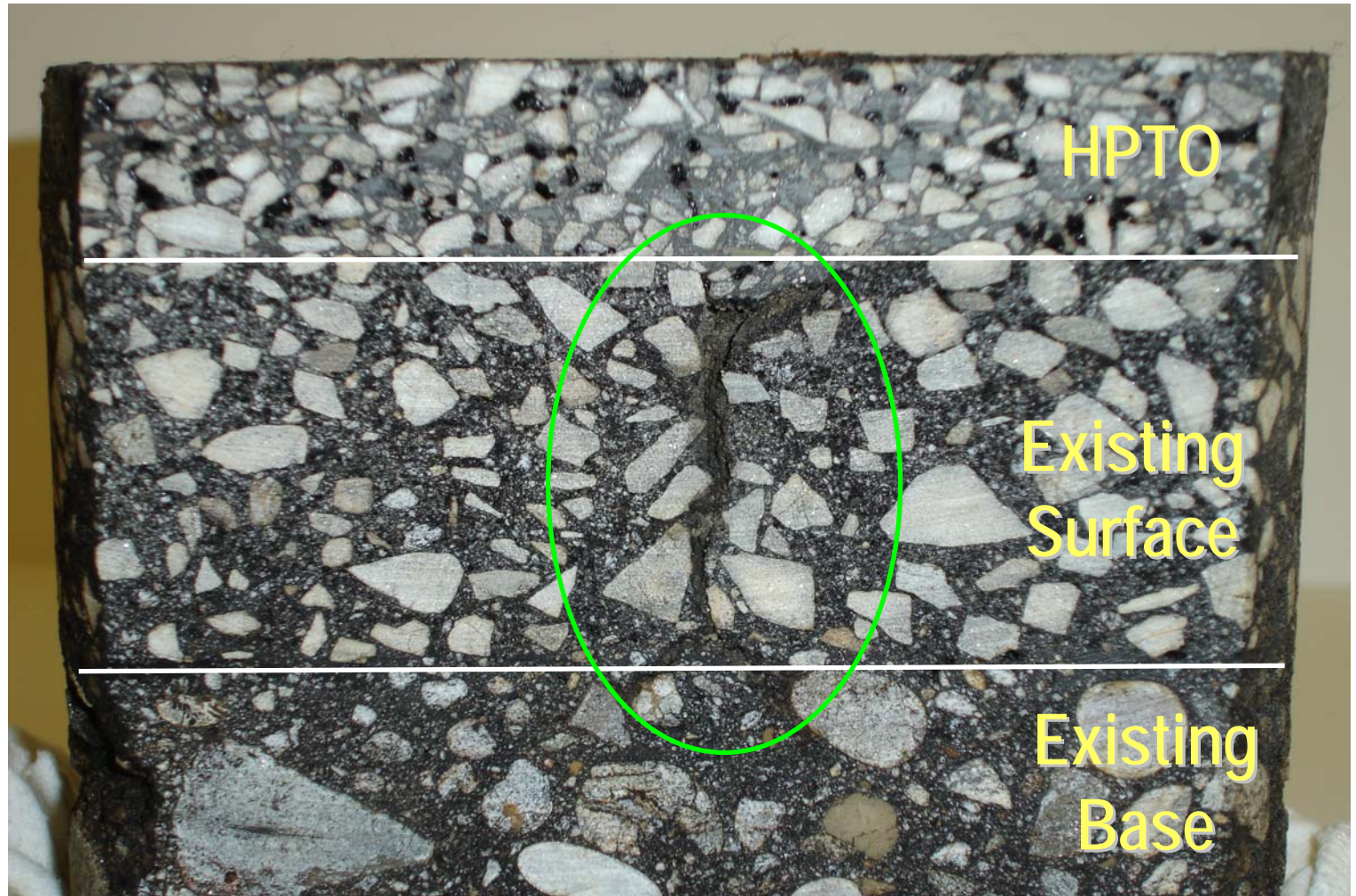

# High Performance Thin-Overlay

- Binder
  - Polymer-modified binder
    - PG76-22 (NJDOT Spec)
  - Minimum Asphalt Content = 6%
- Performance Specification
  - Utilize the Asphalt Pavement Analyzer (AASHTO TP 63) for stability (rutting) check
    - No check for fatigue – low air voids and higher asphalt content will control
    - Must supply for mix design verification and control (1<sup>st</sup> Lot and every other Lot after)



# Typical Permeability Values

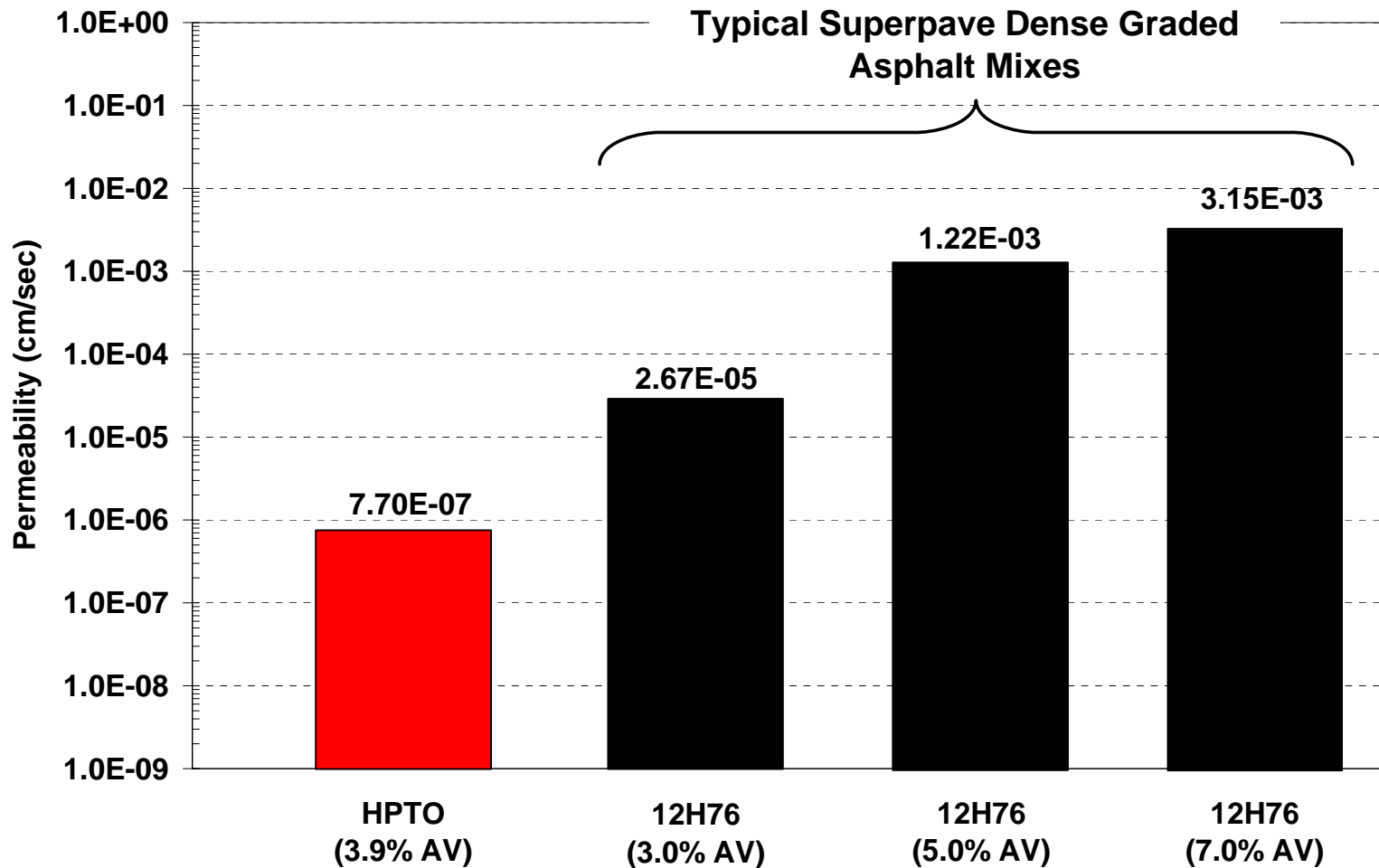

# Surface (Skid) Friction, SN<sub>40</sub>

Material Type	Skid Number
HPTO (New)	53
12.5mm SP (New)	51.6
12.5mm (4 Yrs)	54.3
19mm SP (4 Yrs)	55.7
19mm SP (5 Yrs)	47.7



# HPTO Test Section – Paulsboro, NJ





# NJDOT HPTO

- Still in experimental stage
- 2 projects using it as surface course
  - Evaluating general performance over next year or two
- Currently being used as better performing Leveling course



# Quiet Pavements

# Roadway Noise Generators

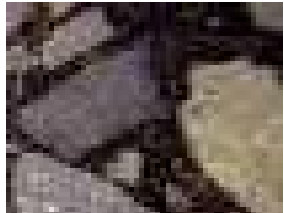

- For  $\geq 20$  to 30 mph, pavement/tire noise dominates.

*(Billera, et al., TRR 1601)*



- Major noise generators:
  - engine,
  - exhaust system,
  - aerodynamic noise, and
  - tire/pavement interface noise.

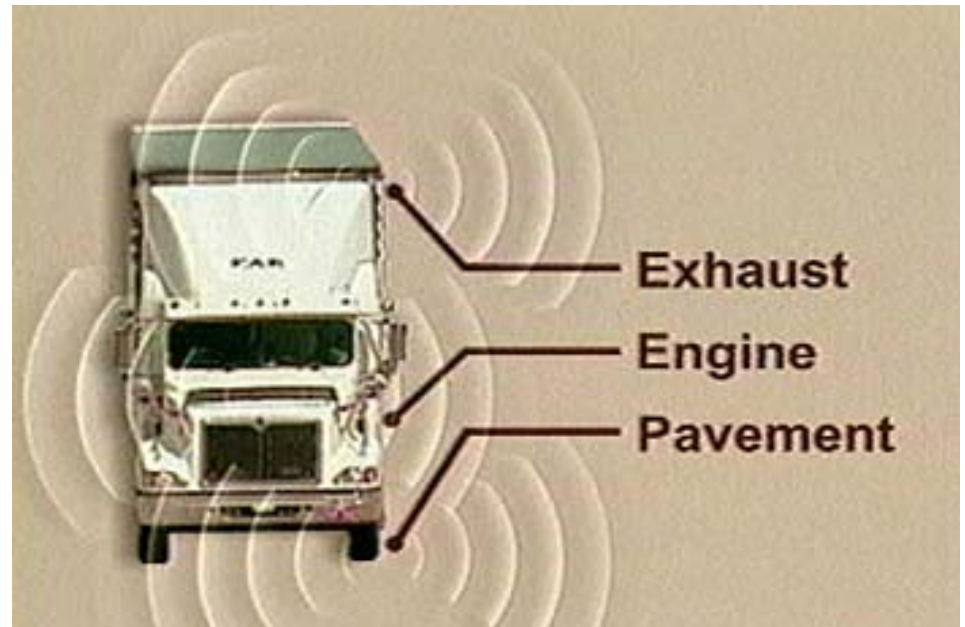





# Approximate “Cross-over Speeds”

<u>Vehicle Type</u>	<u>Cruising Speed</u>	<u>Accelerating Speed</u>
Cars (< 1995)	18 to 25 mph	25 to 31 mph
Cars (> 1995)	10 to 15 mph	18 to 28 mph
Trucks (< 1995)	25 to 31 mph	31 to 35 mph
Trucks (> 1995)	18 to 25 mph	28 to 31 mph

Pavement surface only effective when vehicle speeds are greater than “Cross-over Speeds”



# To Put Noise in Perspective

- 1 dB(A) means a 12% decrease in noise
- 3 dB(A) means a 40% decrease in noise
- 6 dB(A) means a 200% decrease in noise

As a rule of thumb, the human hear can start to differentiate between two sound levels when they are different by more than 2 to 3 dB(A).

# Three Main Mechanisms of Tire-Related Noise Generation

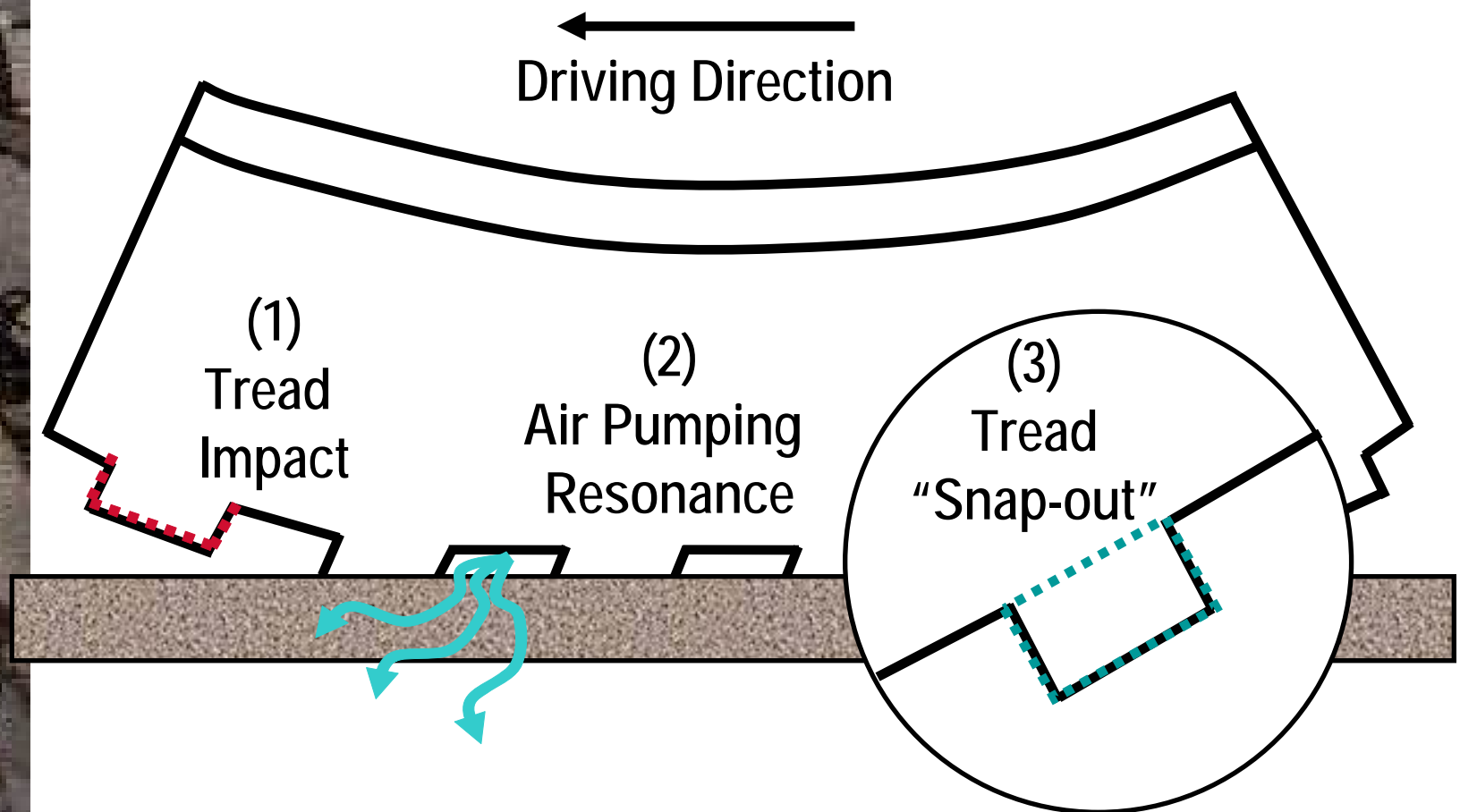

Different tire tread patterns will develop different noise levels  
- Typically, the more aggressive, the more tire/pavement noise -

**Meets ISO 11819-2**



**Close Proximity  
(CPX)**

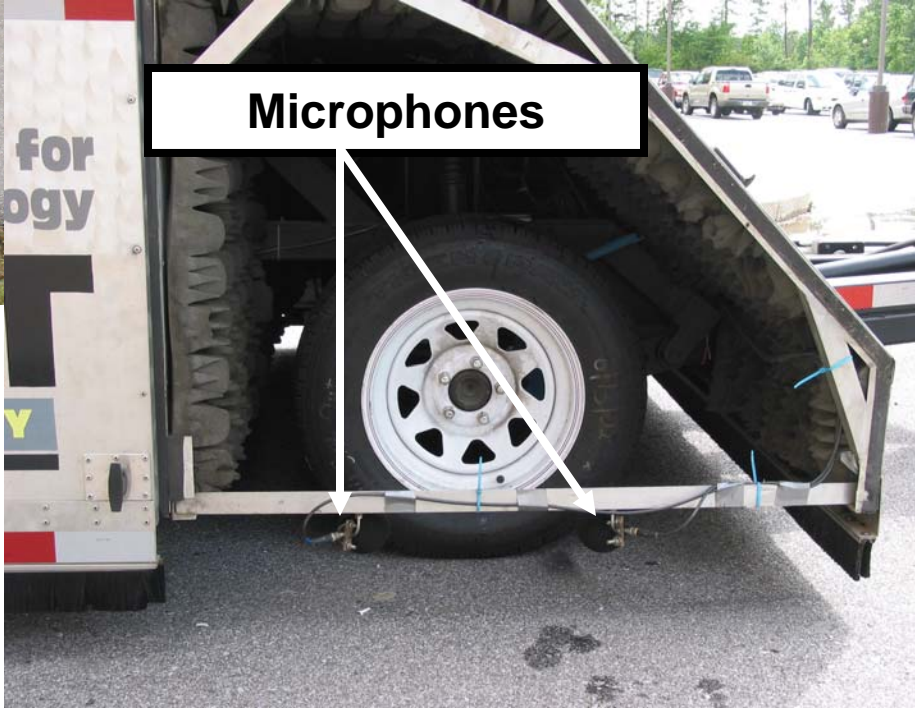

# Sound-Intensity







# Traditional Test Measurements - Wayside

- Statistical pass-by method
  - Based on measuring the noise level from a minimum of 180 single-vehicle passbys
  - Can compare pavements at different locations
  - Microphones generally set at 50 ft from roadway
- Controlled pass-by
  - Same as statistical pass-by but with limited number of vehicles
- Time-averaged method
  - Noise-level is measured continuously over a time period
  - Traffic counts & metrological data is needed

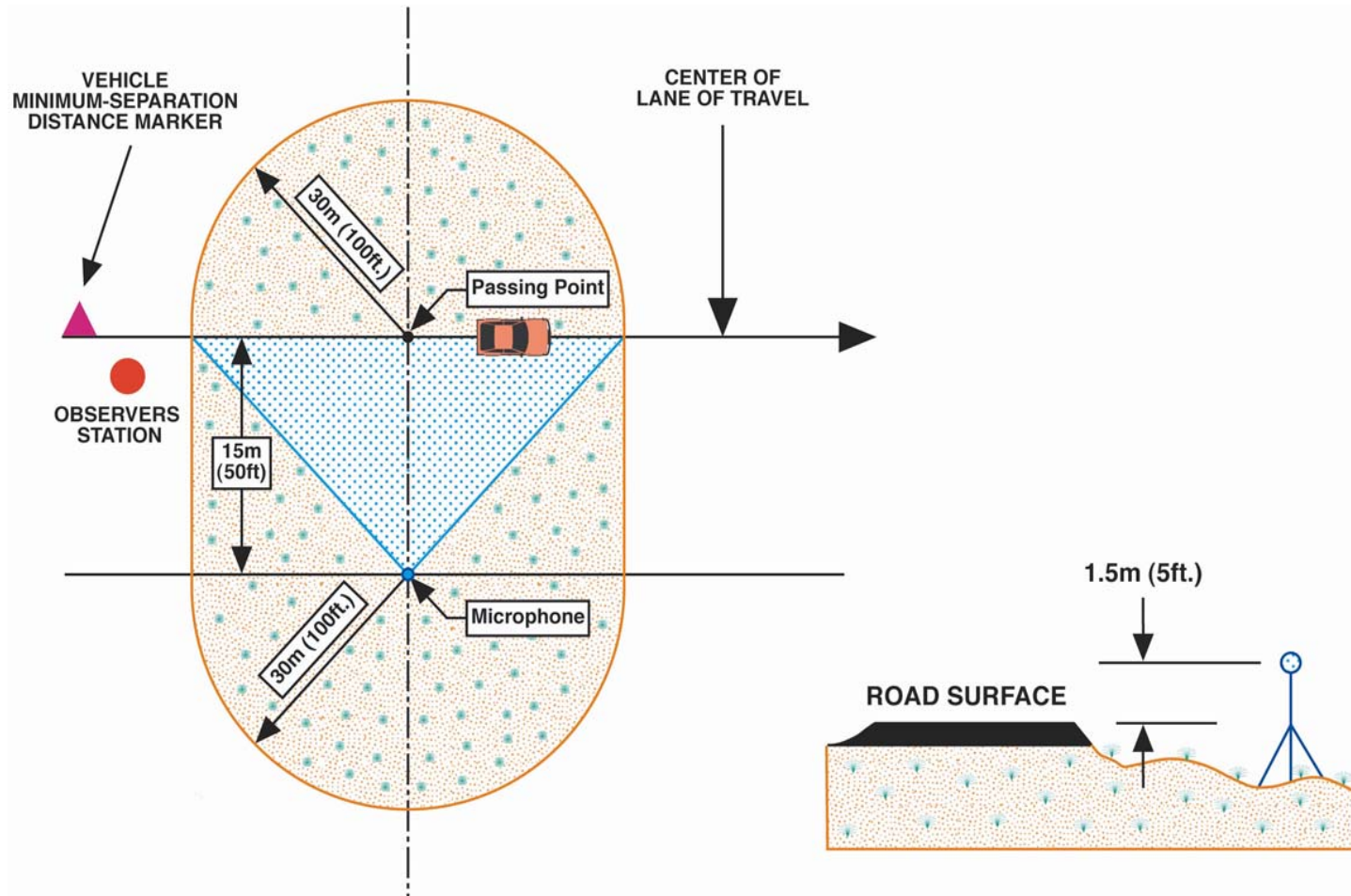
# Wayside Measurements – Site Layout



**Difficult and Time Consuming to Achieve Proper Conditions**



# Pavement Noise Study (FHWA-NJDOT-2003-021)

- Measure Pavement/Tire Related Sound
  - Used Close Proximity Method
- Evaluate the effect of traffic speed
- Total of 42 pavement surfaces tested
  - HMA – OGFC, SMA, Novachip, Micro-surfacing Superpave (12.5 & 19mm), SHRP Sections
  - PCC – transverse tining, diamond grinding, no finish





# DGA Pavement Surfaces

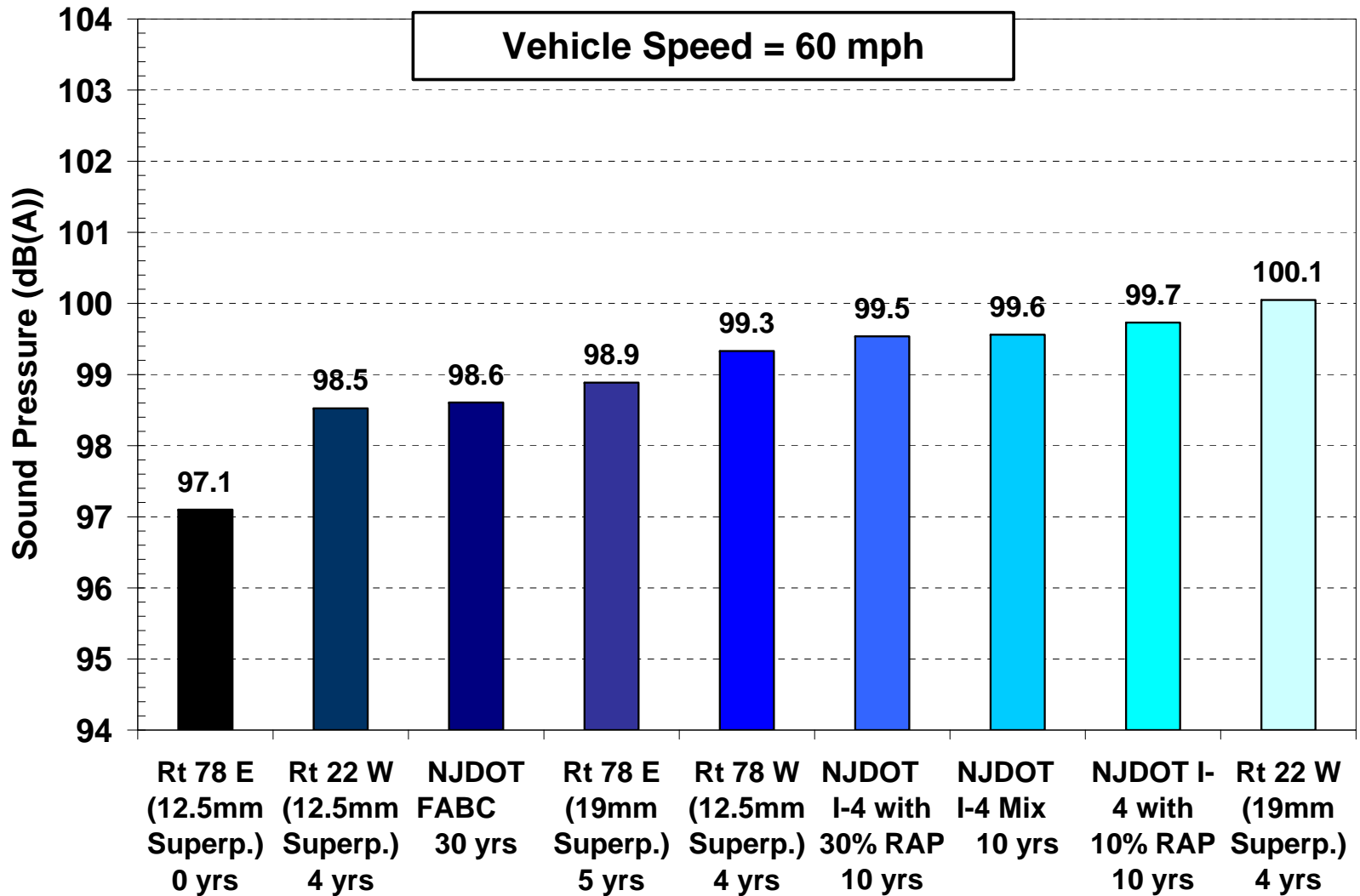

**Noise increases with size and HMA aggregate**

# OGFC Surfaces

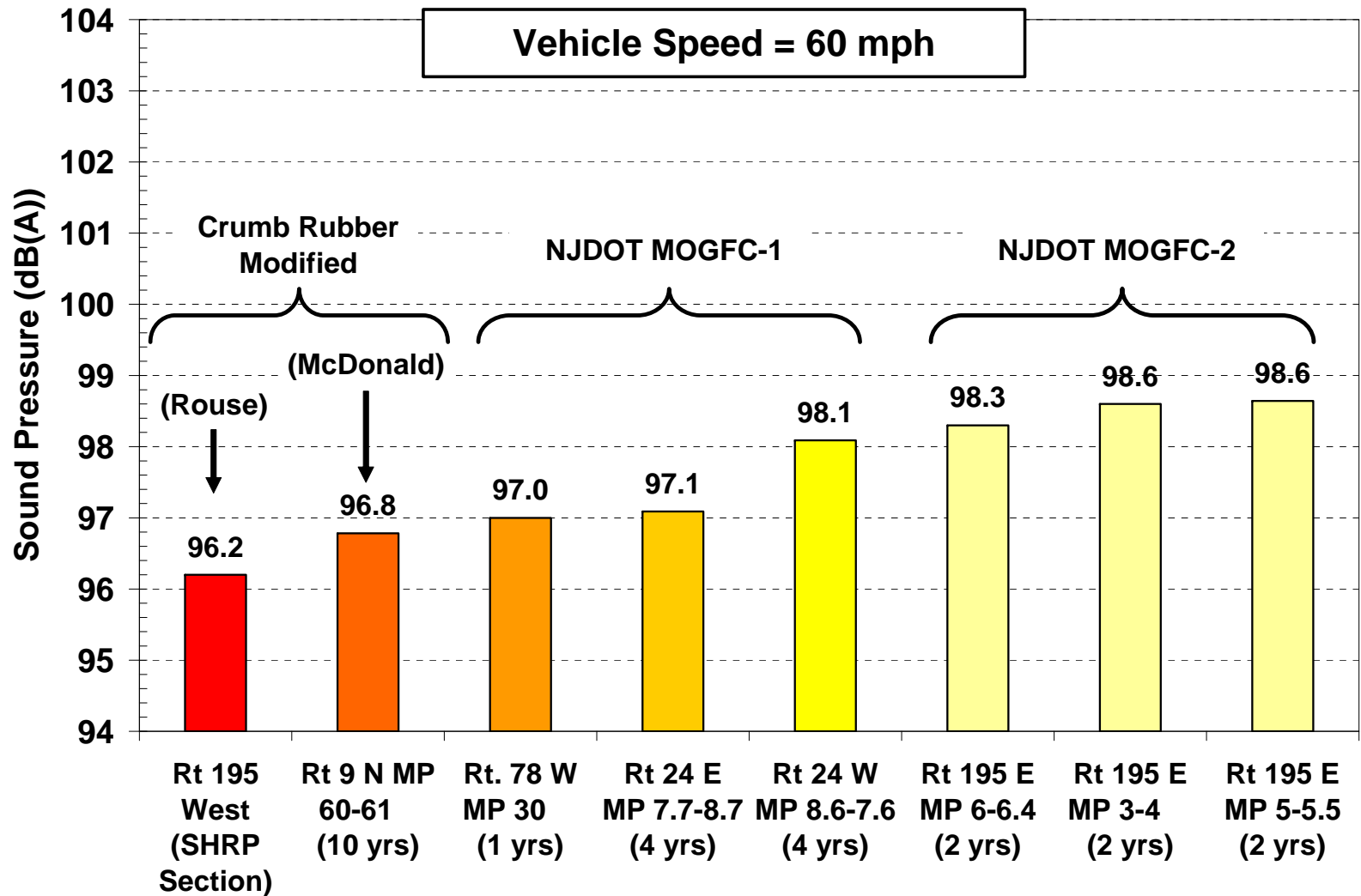

**Finer OGFC with asphalt rubber quieter**



# SMA (Stone Mastic Asphalt) Surfaces

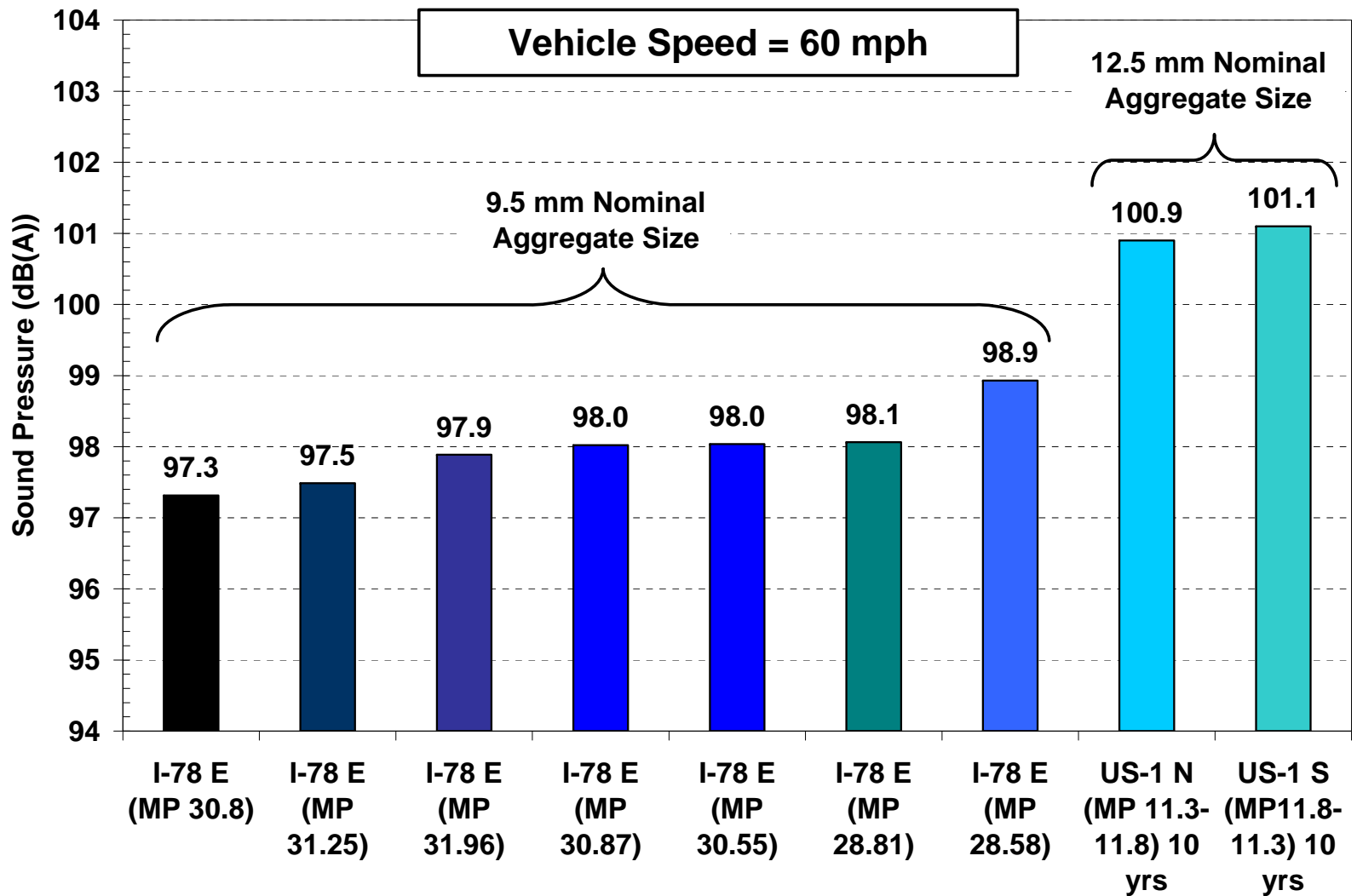

**Noise increases with size and HMA aggregate**



# “Thin-Lift” Surface Treatments

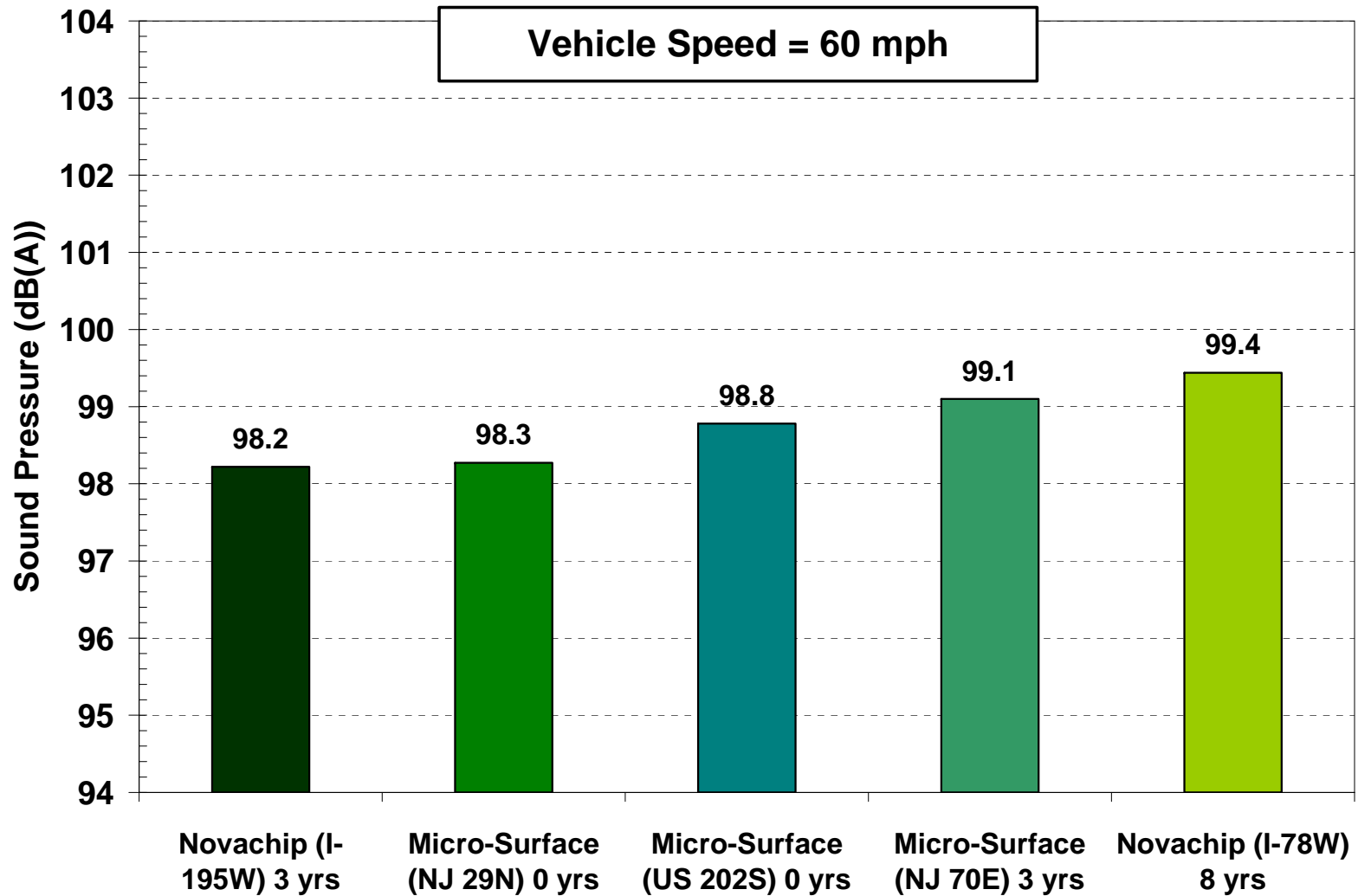

**Noise increases as the pavement ages and stiffens**

# Concrete Surface Treatments

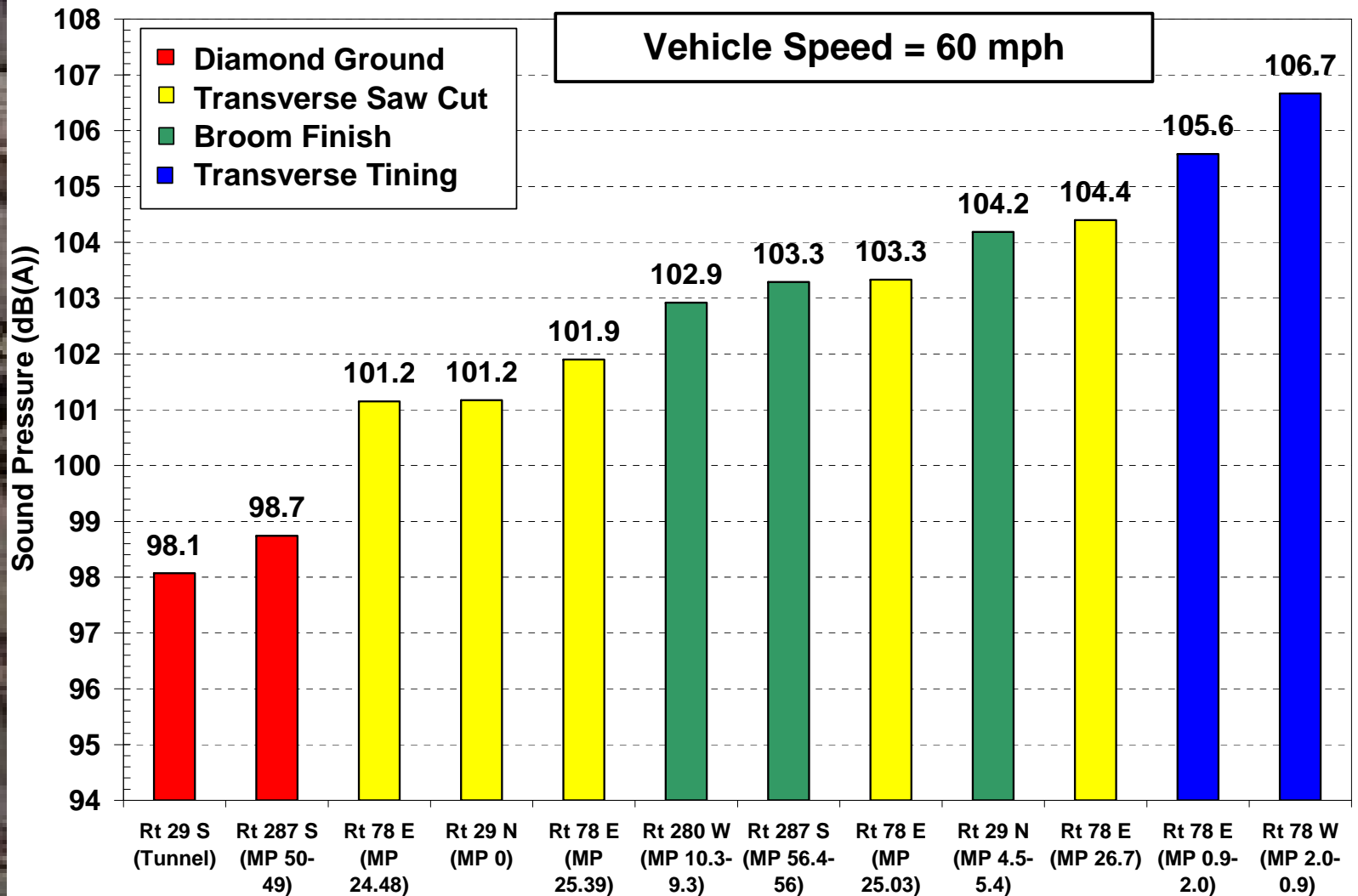

# 10 Quietest Pavement Surfaces Tested

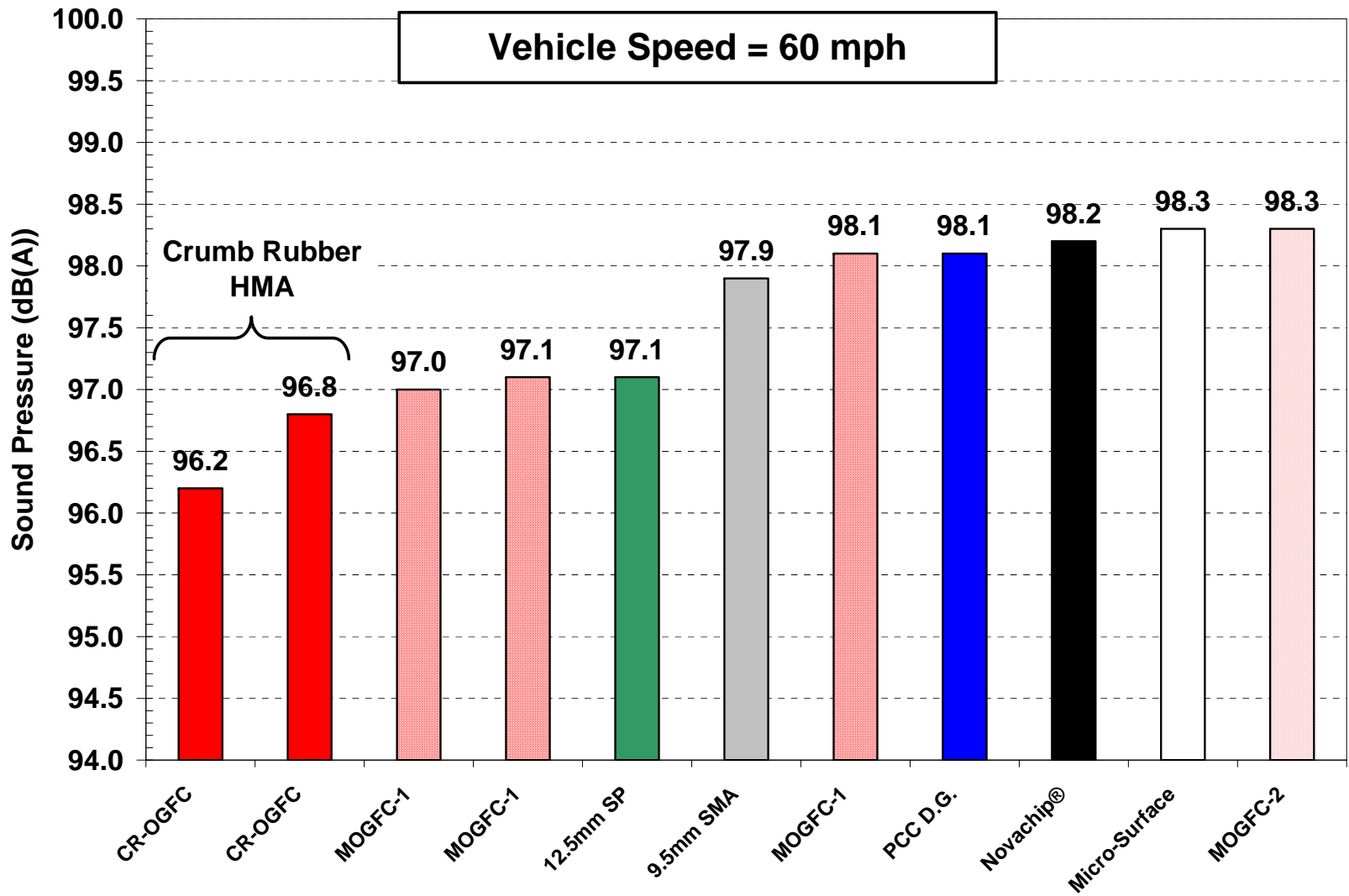

# Quietest to Loudest Comparison

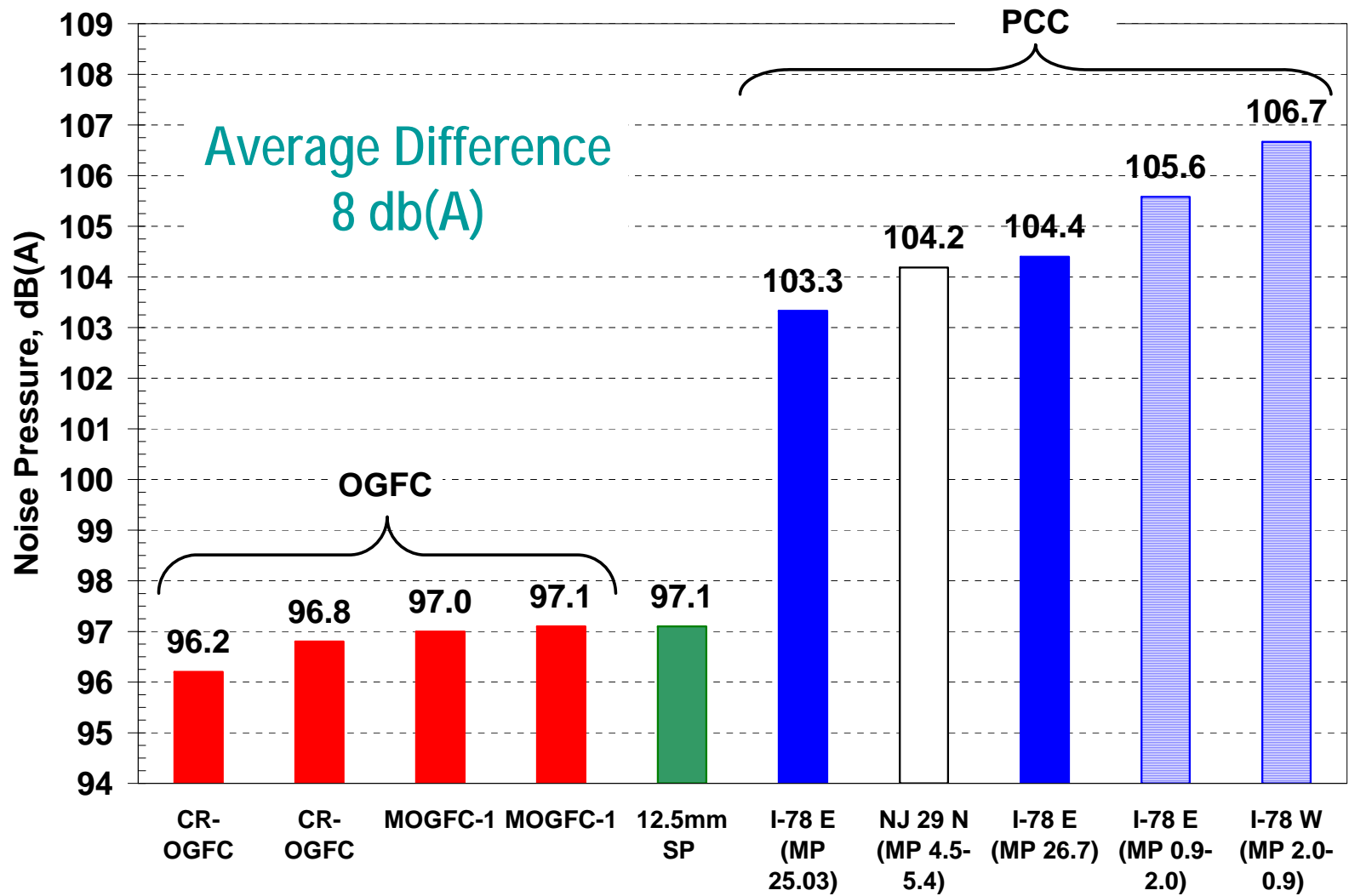





# NJ Compared to Average

- Based on 10 states (244 pavements)

<u>Pavement Type</u>	<u>Noise (dB(A))</u>	
	<u>NJ</u>	<u>Average</u>
DGA	99.1	97
OGFC (Coarse)	97.6	97
OGFC (Fine)	N.A.	93
SMA (9.5mm)	97.9	96
SMA (12.5mm)	101	96



# Main Conclusions from NJ Research

- Different pavement surfaces generate various levels of noise
  - Finer graded HMA generated less noise
  - HMA lower than typical PCC (D.G. PCC similar)
  - Over 10 dB(A) difference from highest to lowest
    - OGFC vs Transverse Tined PCC
- Generated tire/pavement noise correlated to ride quality
  - Influenced by same macro-texture properties
    - Tire/pavement noise may influence a “users” perception of a “smooth ride” (based on RQI results – IRI was similar)
    - A SMOOTHER RIDE MEANS LESS NOISE!



# Designing a Quiet Pavement

- Based on numerous field studies in Europe and United States
  - An open graded mix (OGFC) with more than 15% air voids and 90 to 100% passing the 3/8" sieve
    - Not suitable to use everywhere
  - Other fine graded HMA can also be utilized, but not as effective (9.5mm SMA, 9.5mm HMA)
  - European Concept (experimental) - using a two layer concept
    - 3/4 inches of a fine graded OGFC
    - 1 1/2 inches of a coarse graded OGFC



# OGFC for Quiet Pavement - Restrictions

- OGFC should only be used on pavements with “free-flowing” traffic
  - No frequent stopping, intersections, sharp curves
  - Fast moving traffic “self cleans” OGFC
  - Winter maintenance may be issue – recommend using rock salt pre-wetted with calcium chloride
    - Typically uses twice application of Dense Graded HMA
- For areas of potential frequent stopping, better to use a fine-graded HMA or SMA
  - Will not clog
  - Easier for winter maintenance
  - Remember, only beneficial if traffic > 35 mph



# Composite Pavement Issues

(HMA overlay PCC)

# What? The Problem

- **Superpave didn't address cracking in general, especially reflective cracking**
- **45% of NJDOT pavements are composite (HMA over PCC), with another 10% PCC to be overlaid!**
- **Conventional HMA overlays not addressing need**
- **Why is Reflective Cracking a Problem?**



# Reflective Cracking - Mode 1

- Mode 1 Vertical Shear
  - Poor load transfer
  - Weak base or voids present
  - Load Associated Problem





**“Poor load transfer...”**

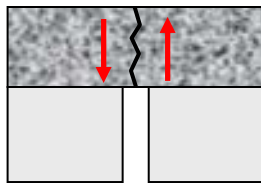
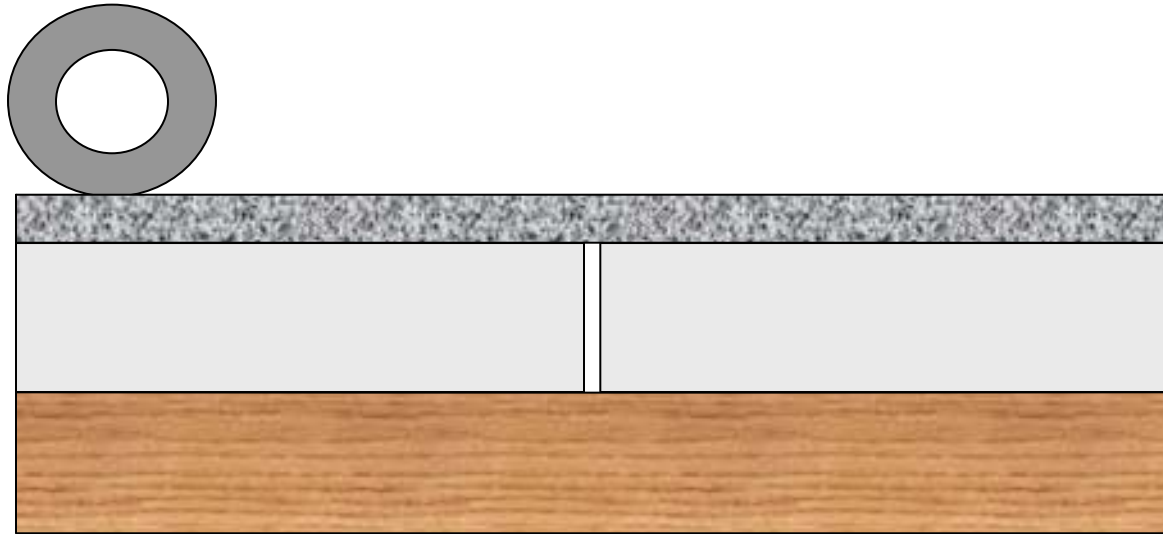

Mode 1: Vertical Shear Stress





**“Poor load transfer...”**

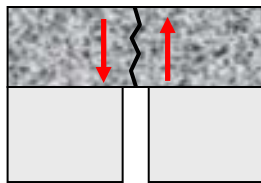
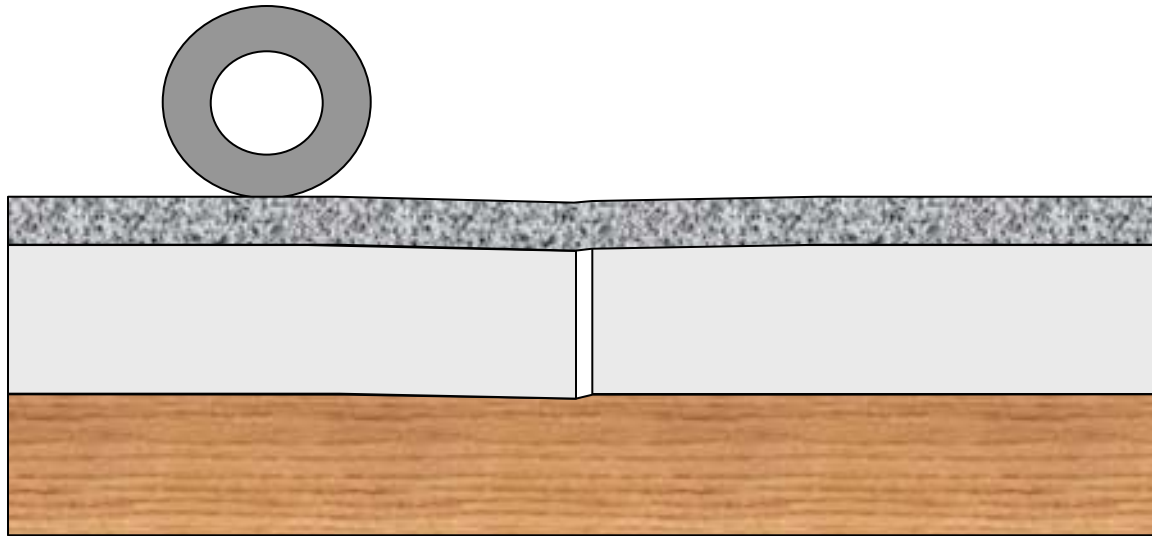

Mode 1: Vertical Shear Stress



**“causes shear stresses in the overlay.”**

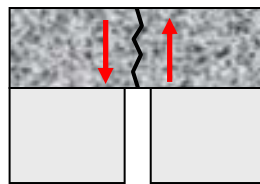
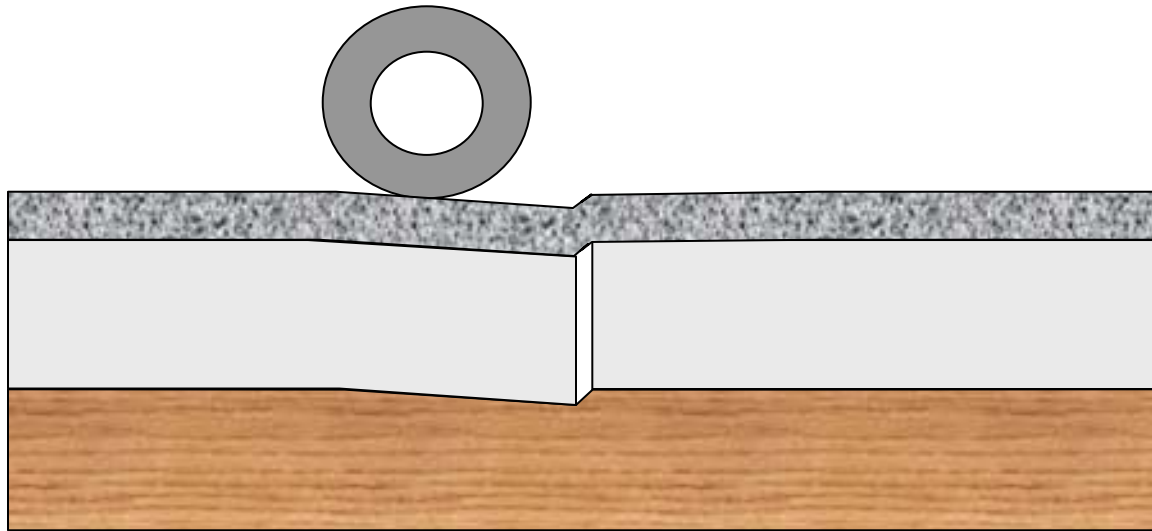

Mode 1: Vertical Shear Stress



**“causes shear stresses in the overlay.”**

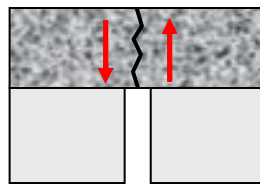
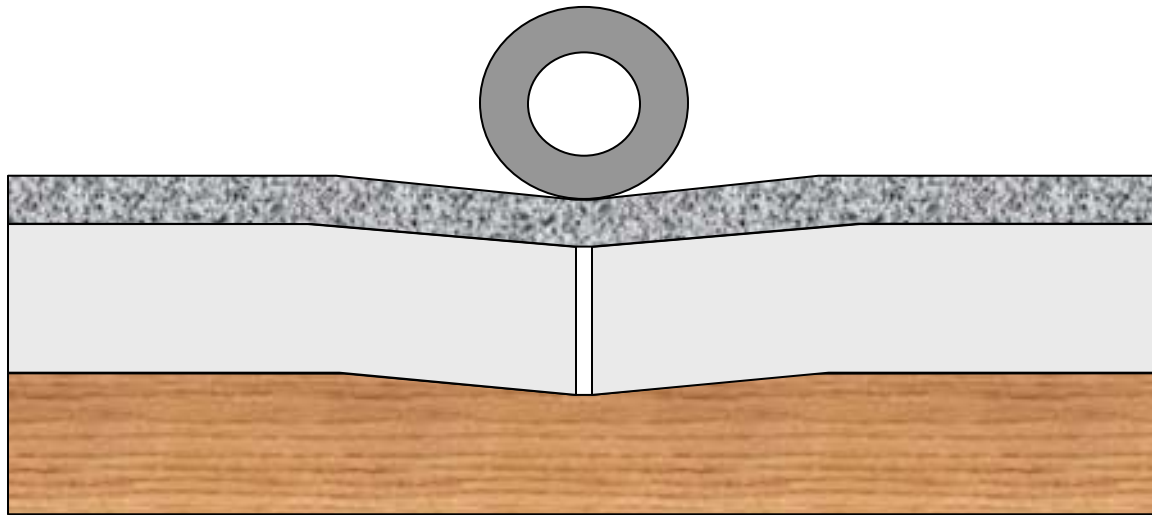

Mode 1: Vertical Shear Stress



**“causes shear stresses in the overlay.”**

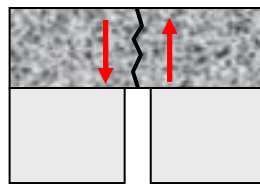
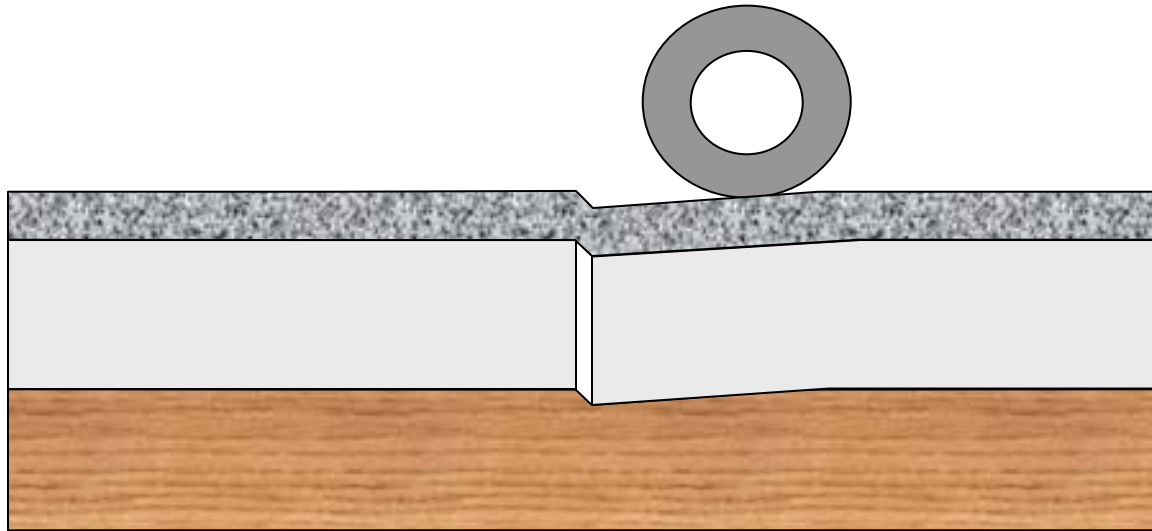

Mode 1: Vertical Shear Stress

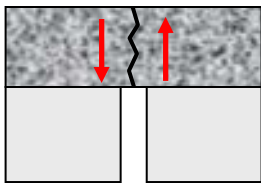
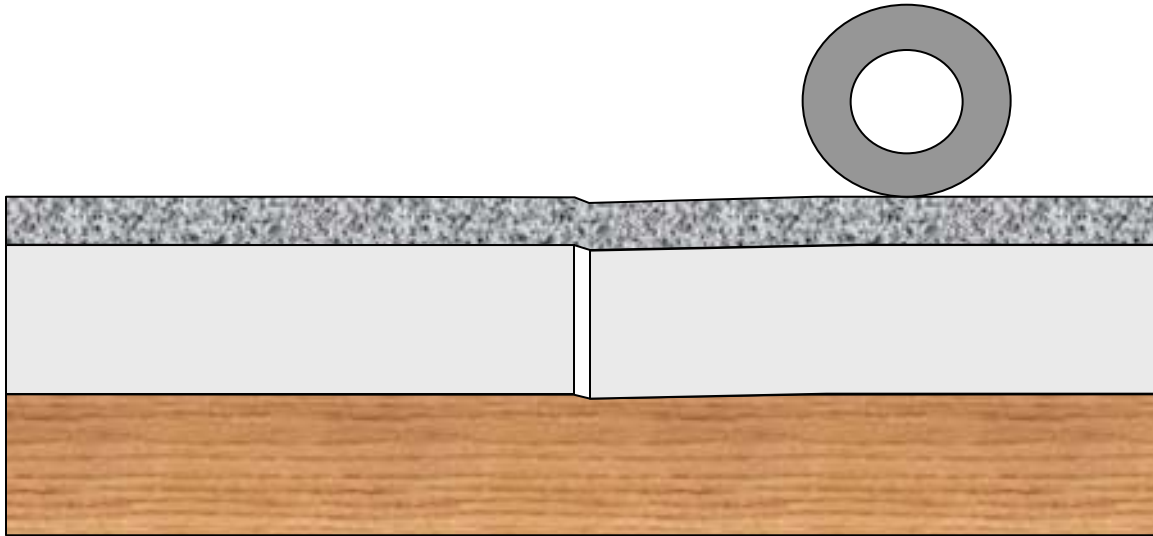

Mode 1: Vertical Shear Stress

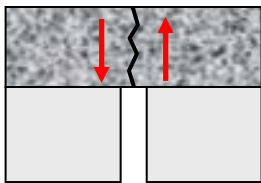
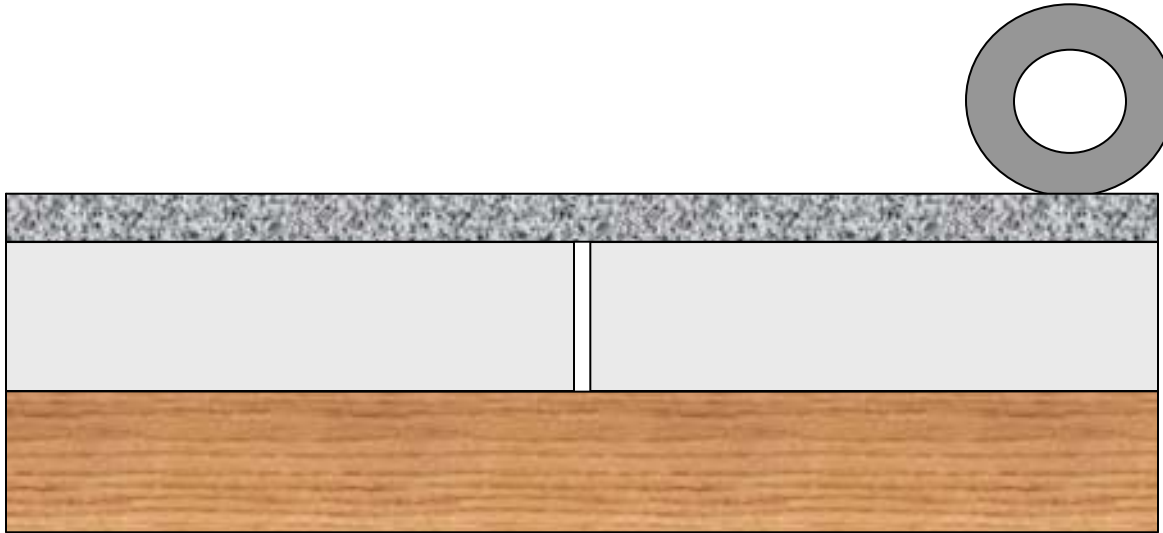

Mode 1: Vertical Shear Stress



**“Over many repeated loads...”**

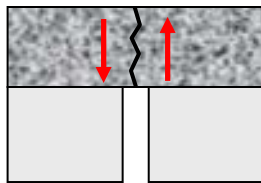
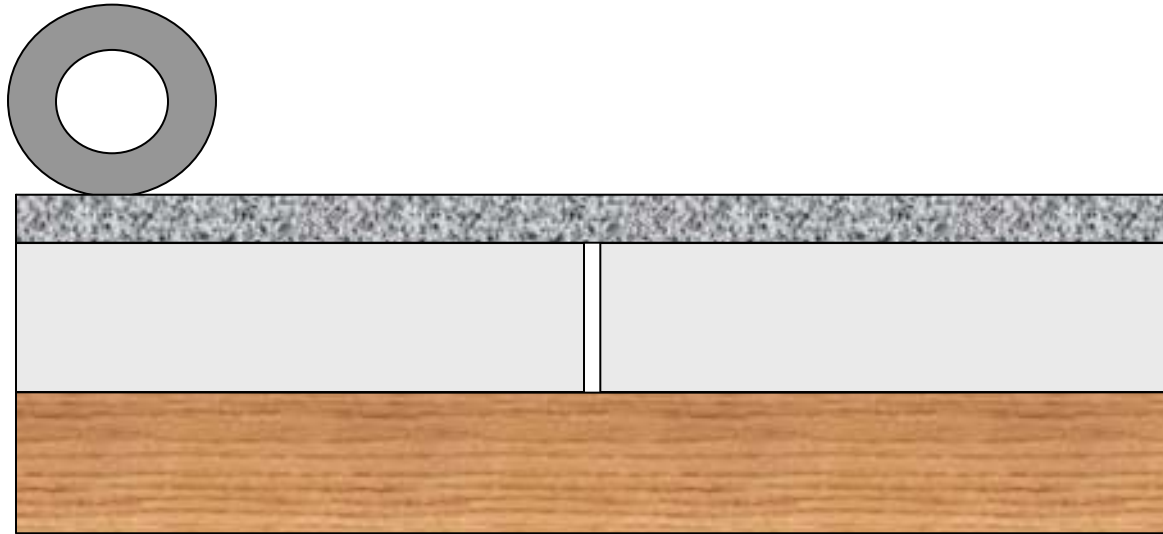

Mode 1: Vertical Shear Stress



**“Over many repeated loads...”**

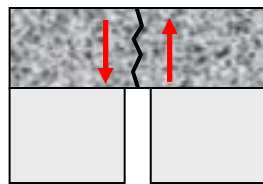
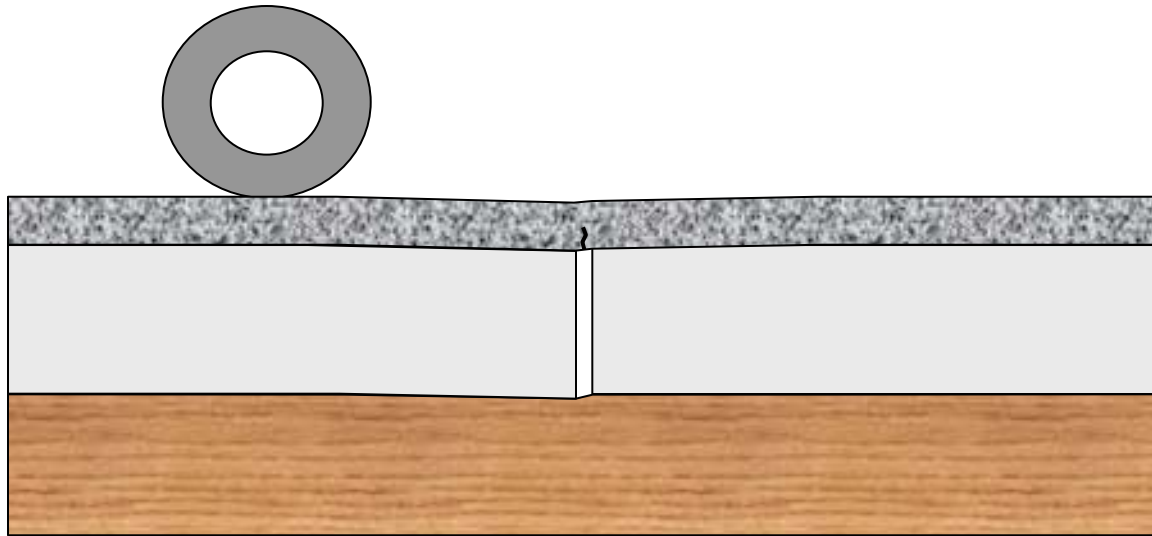

Mode 1: Vertical Shear Stress





**“reflection cracks develop.”**

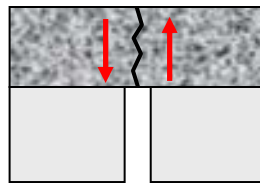
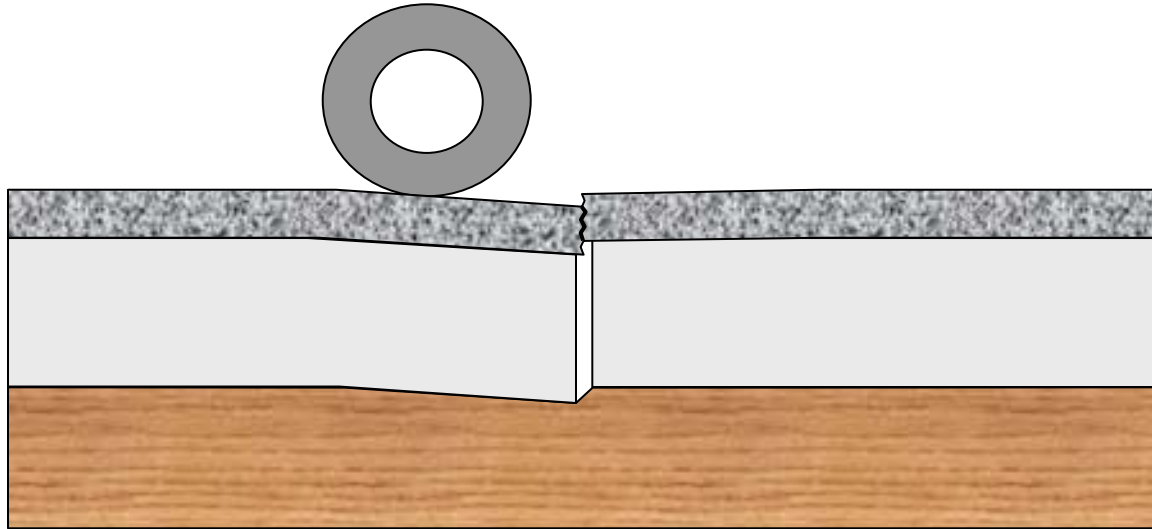

Mode 1: Vertical Shear Stress



**“reflection cracks develop.”**

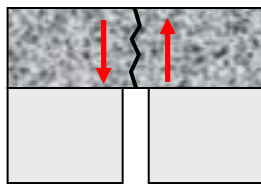
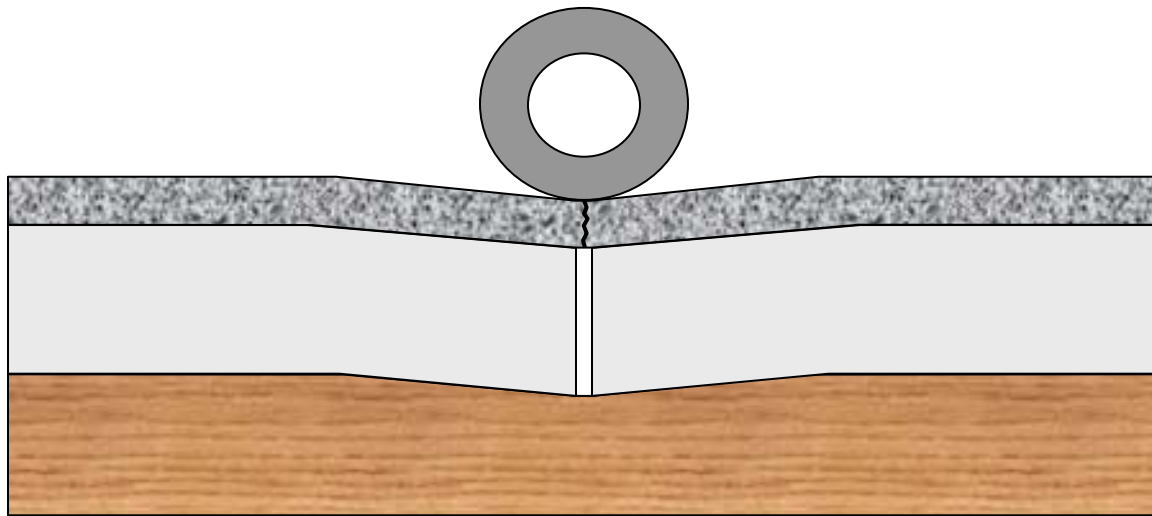

Mode 1: Vertical Shear Stress



**“reflection cracks develop.”**

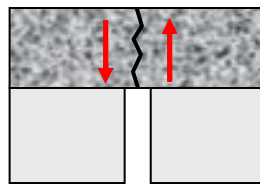
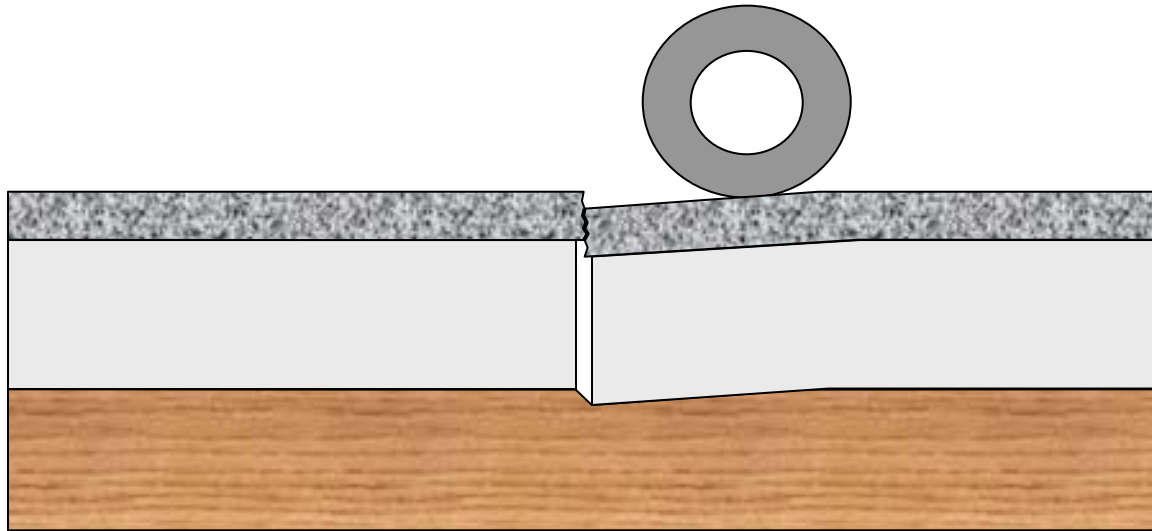

Mode 1: Vertical Shear Stress



**“reflection cracks develop.”**

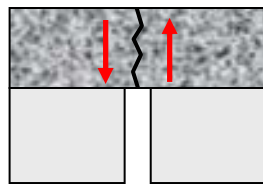
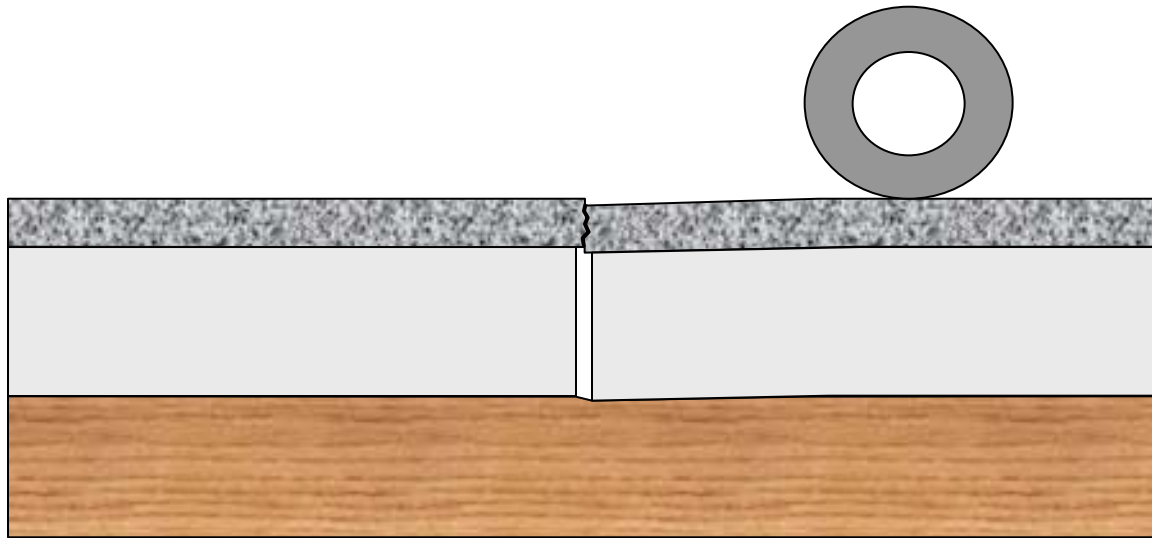

Mode 1: Vertical Shear Stress



**“reflection cracks develop.”**

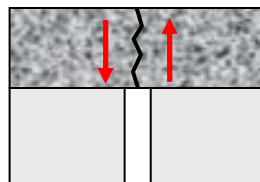
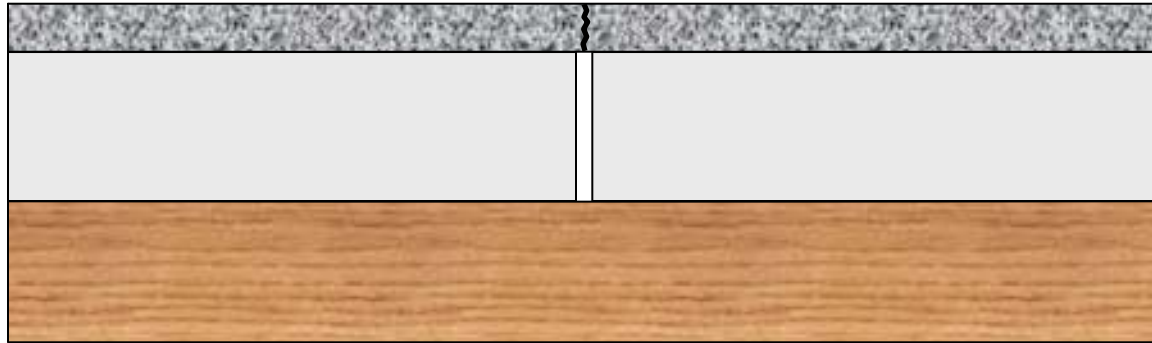

Mode 1: Vertical Shear Stress

# Reflective Cracking - Mode 2

- Tensile stress at bottom of AC layer
  - Poor support
  - Weak base
  - Load Associated Problem





## “Traffic loads at the joint...”

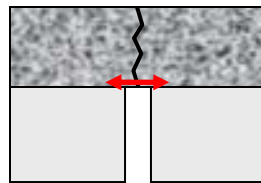
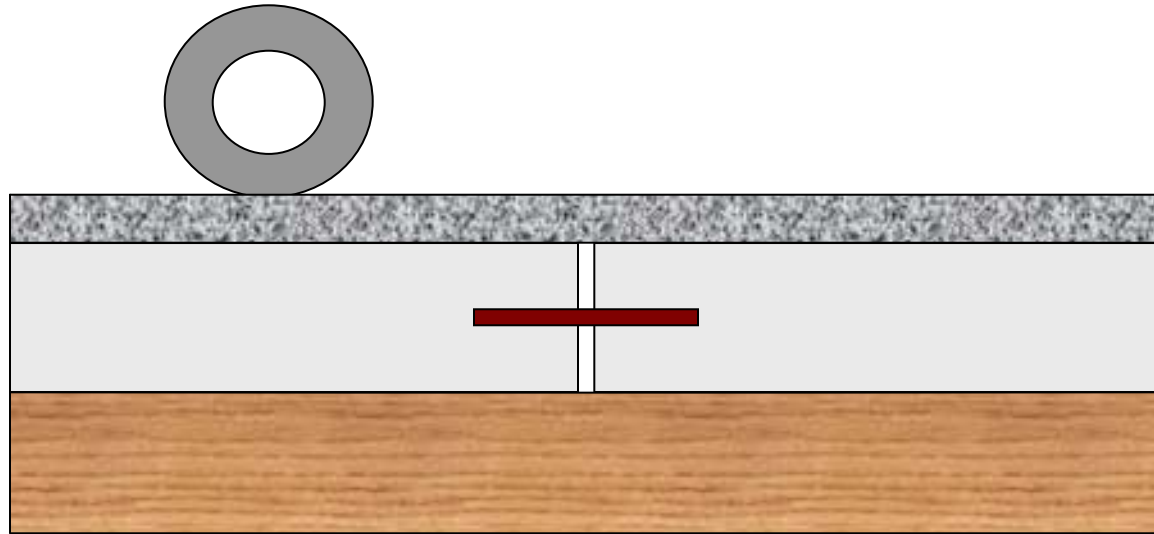

Mode 2: Horizontal Tensile Stress due to load



## “Traffic loads at the joint...”

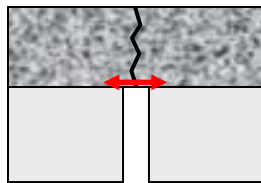
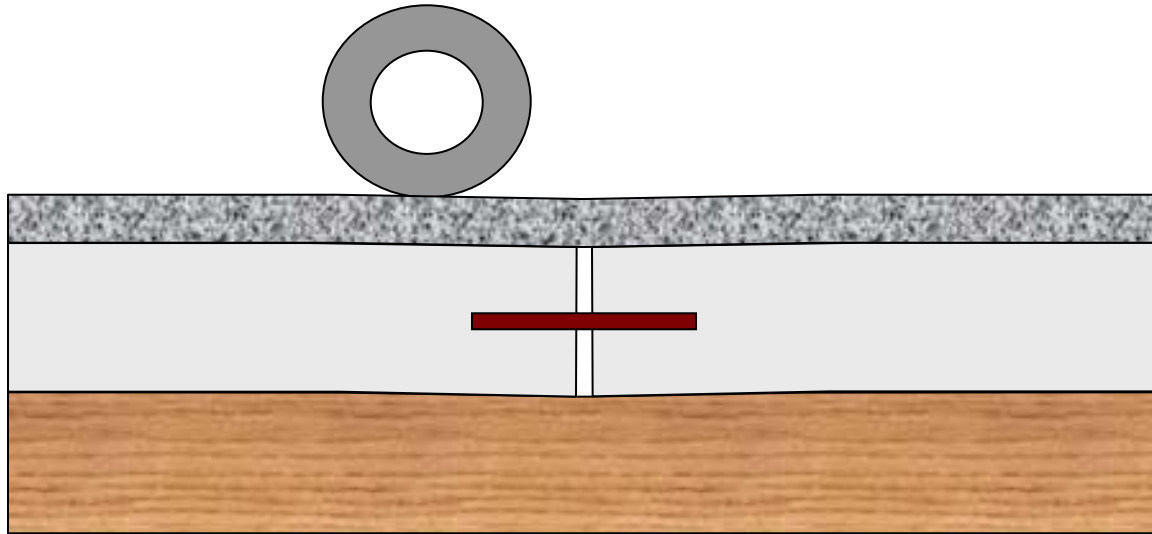

Mode 2: Horizontal Tensile Stress due to load





**“cause tensile stresses at the bottom of the overlay.”**

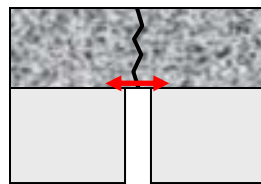
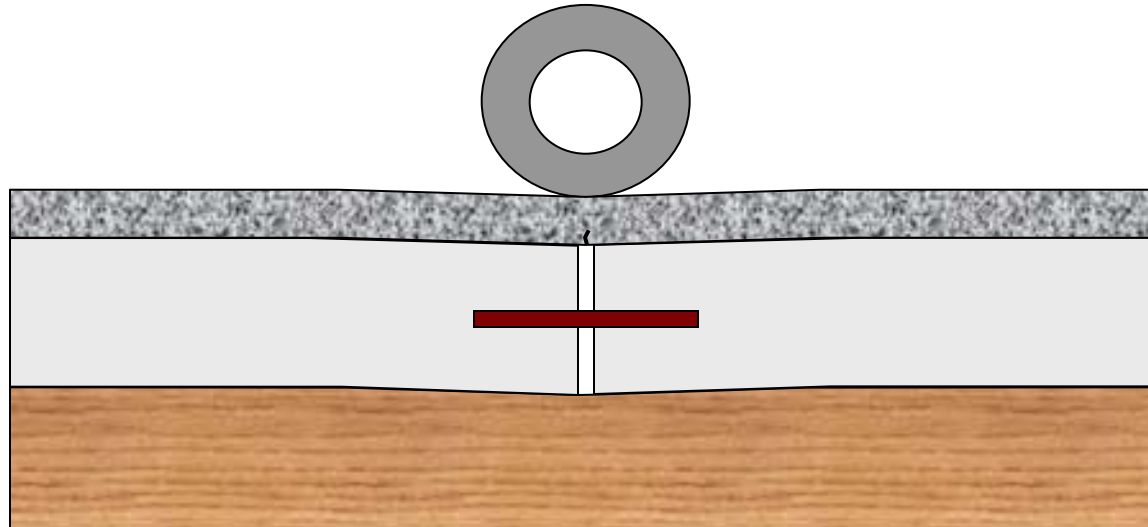

Mode 2: Horizontal Tensile Stress due to load



**“cause tensile stresses at the bottom of the overlay.”**

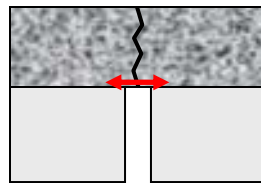
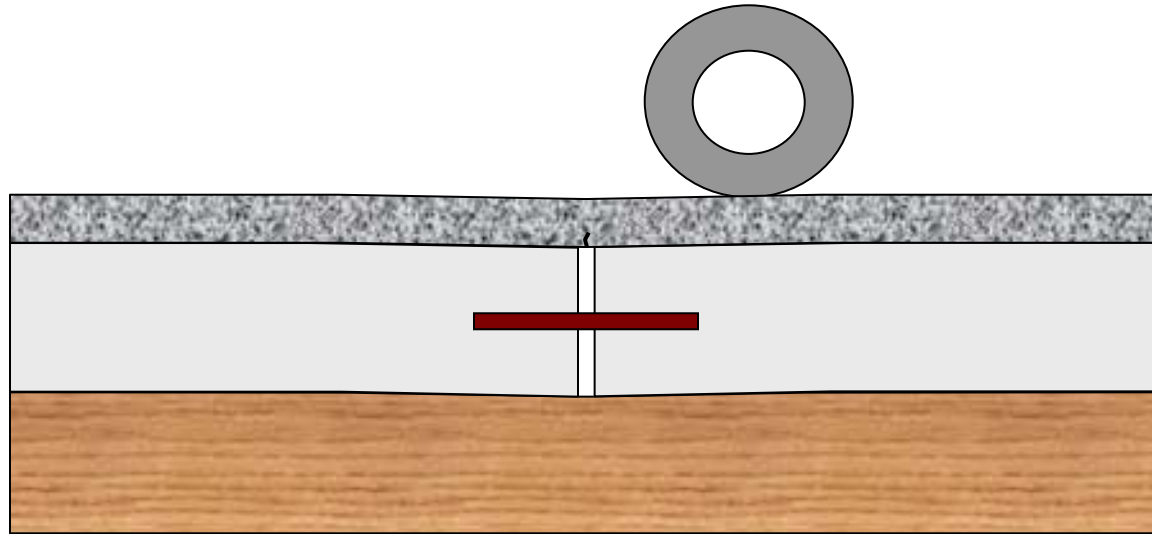

Mode 2: Horizontal Tensile Stress due to load



**“cause tensile stresses at the bottom of the overlay.”**

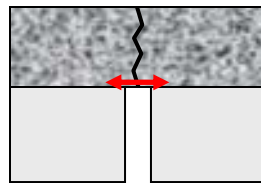
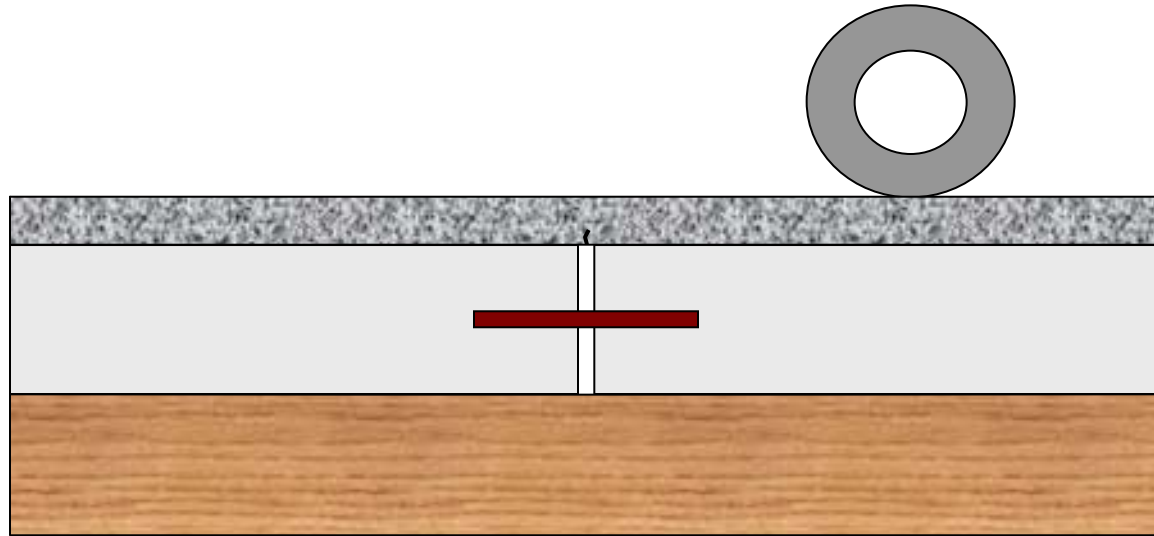

Mode 2: Horizontal Tensile Stress due to load



**“Over many repeated loads...”**

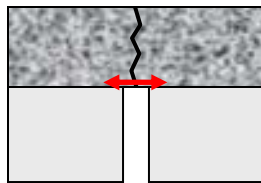
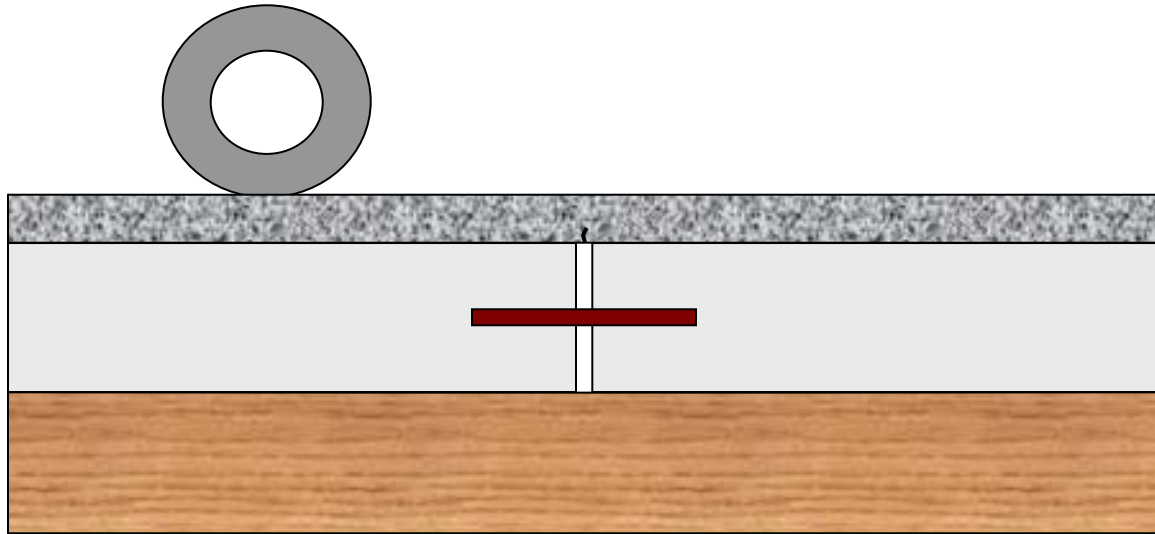

Mode 2: Horizontal Tensile Stress due to load



**“Over many repeated loads...”**

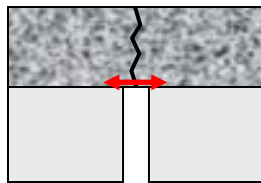
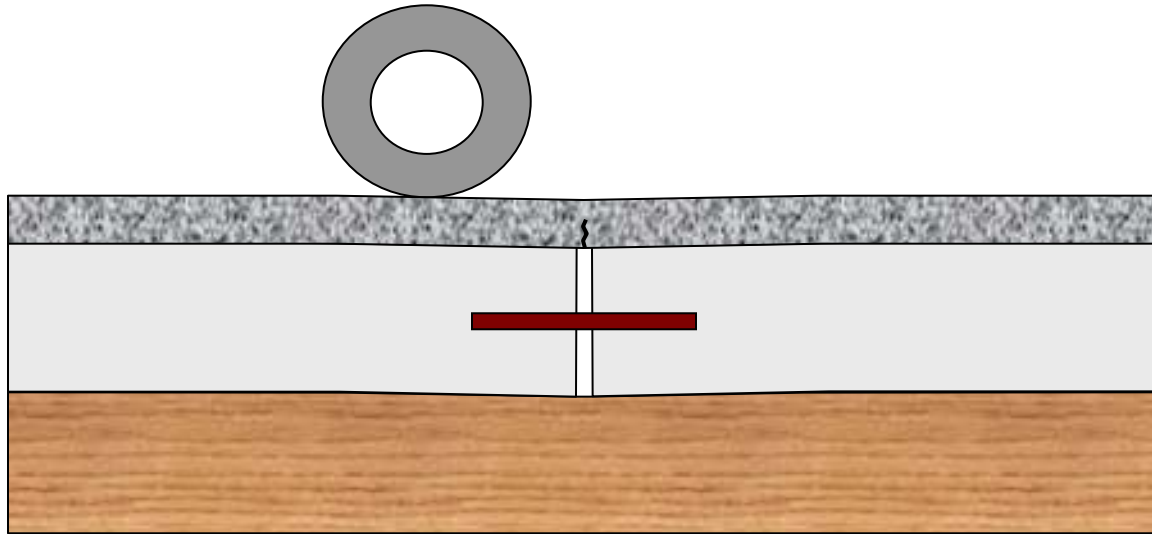

Mode 2: Horizontal Tensile Stress due to load



**“Over many repeated loads...”**

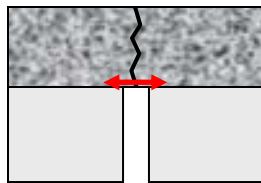
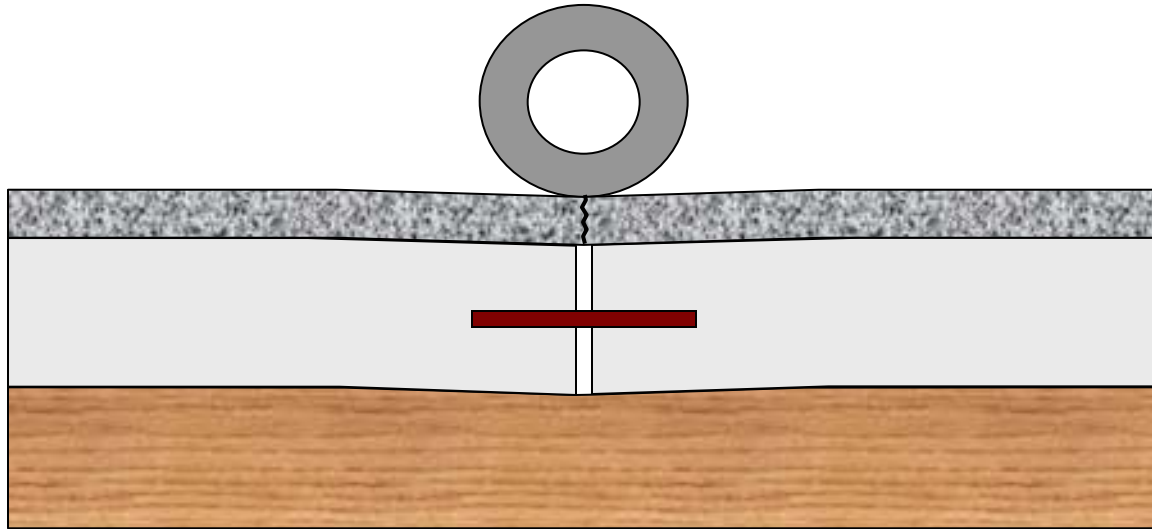

Mode 2: Horizontal Tensile Stress due to load



**“reflection cracks develop.”**

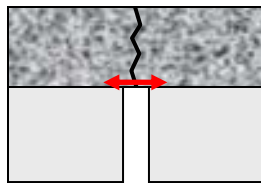
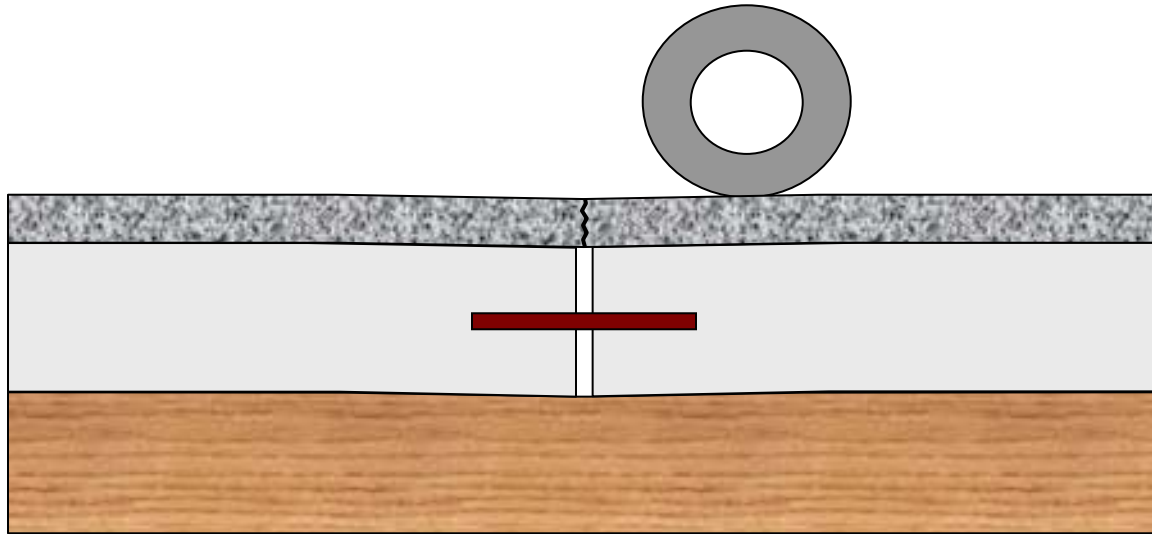

Mode 2: Horizontal Tensile Stress due to load



**“reflection cracks develop.”**

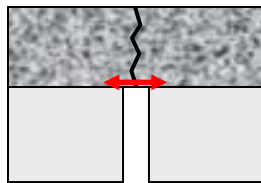
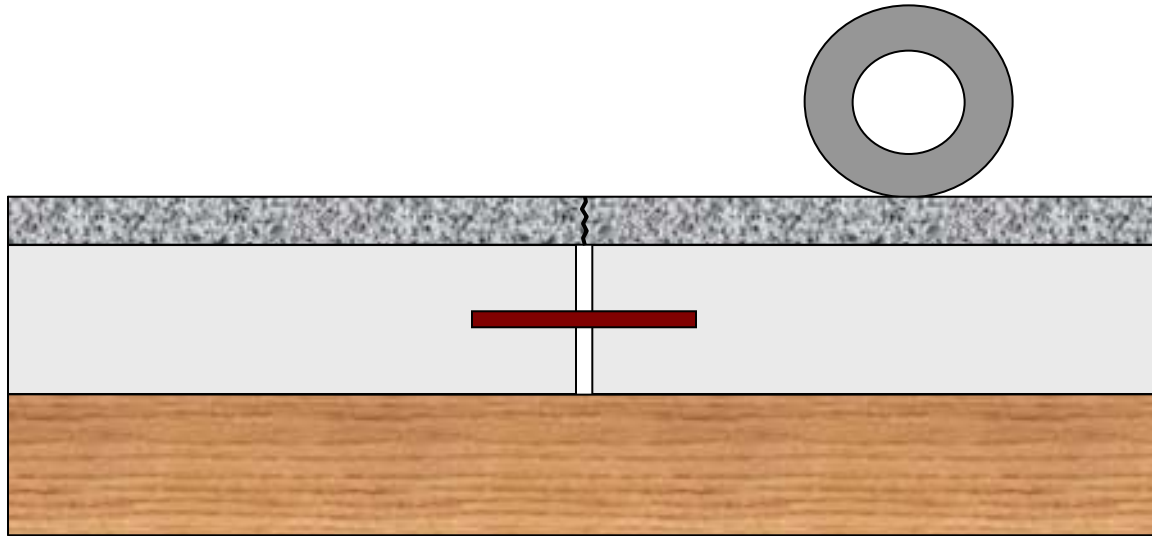

Mode 2: Horizontal Tensile Stress due to load





**“reflection cracks develop.”**

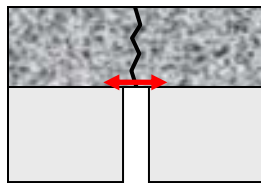
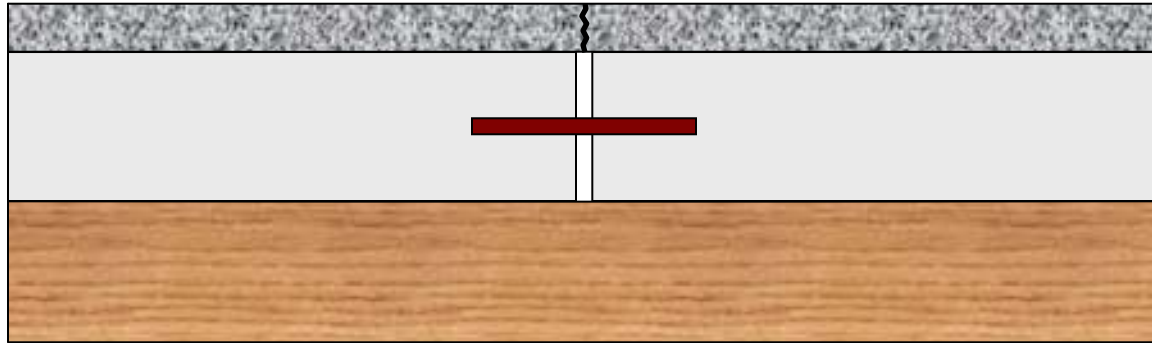

Mode 2: Horizontal Tensile Stress due to load

# Reflective Cracking - Mode 3

- Horizontal Tensile Stress
  - Thermally Induced stresses
  - Magnitude depends on Slab length or Crack spacing





**“Slab shrinkage under cooling temperature...”**

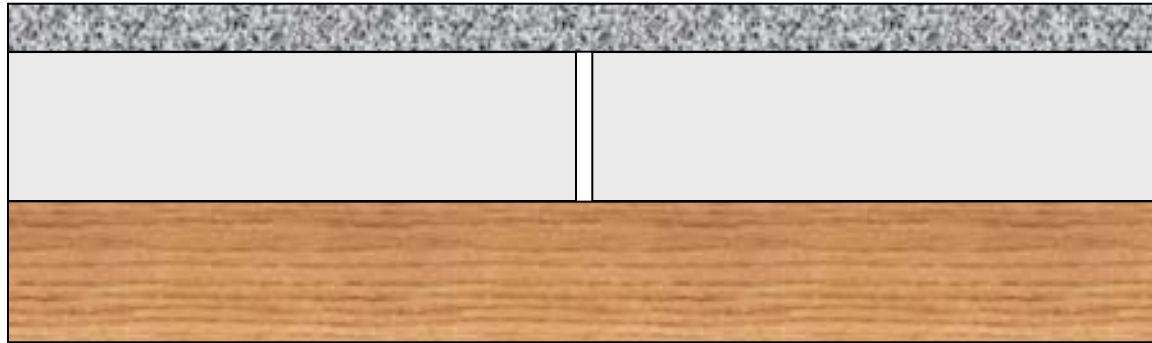

Mode 3: Horizontal Tensile Stress due to climate



## “Slab shrinkage under cooling temperature...”

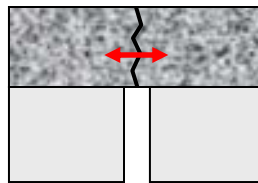
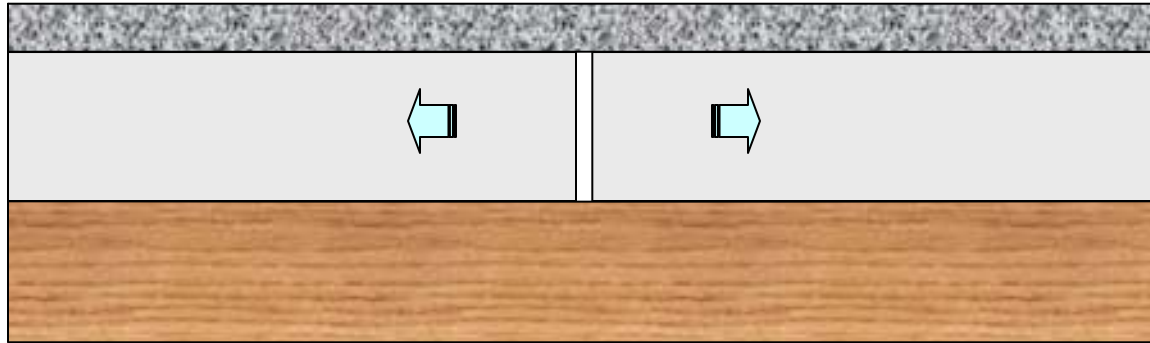

Mode 3: Horizontal Tensile Stress due to climate



**“Slab shrinkage under cooling temperature...”**

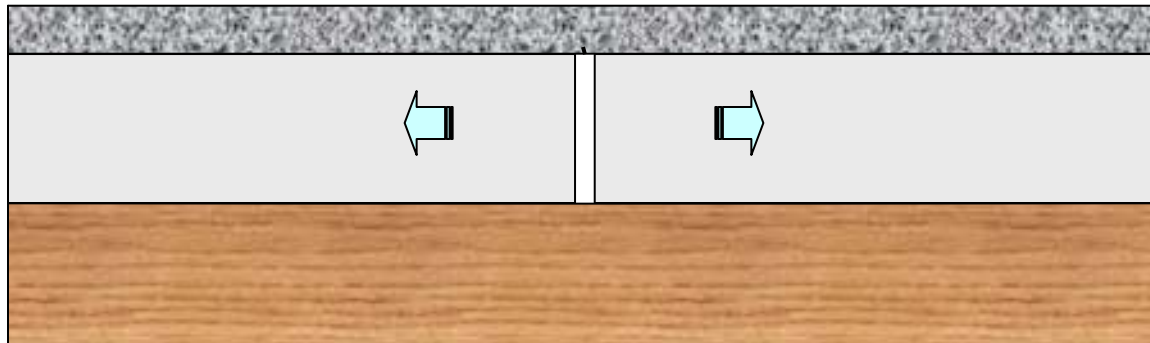

Mode 3: Horizontal Tensile Stress due to climate



**“causes tensile stresses in the overlay.”**

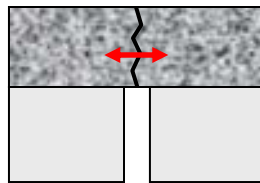
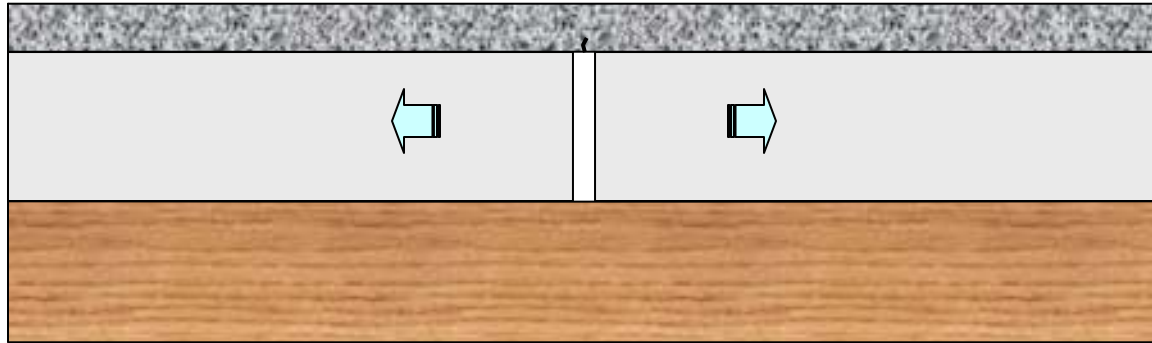

Mode 3: Horizontal Tensile Stress due to climate



**“causes tensile stresses in the overlay.”**

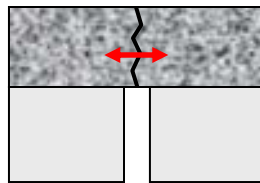
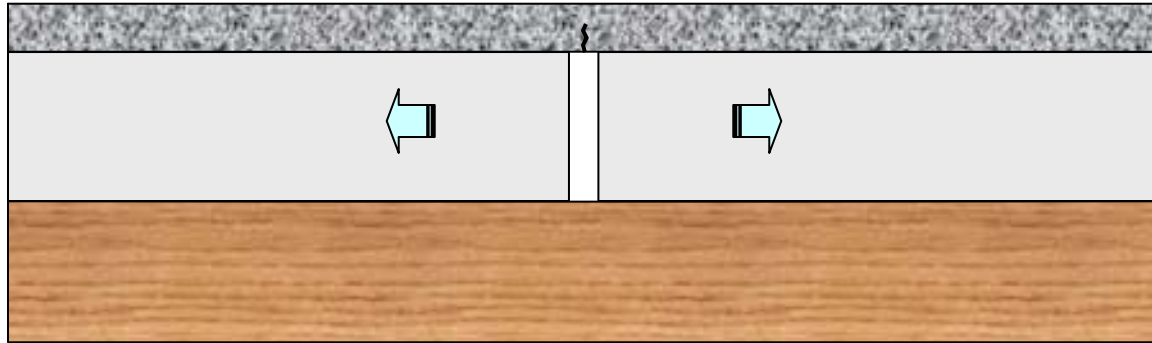

Mode 3: Horizontal Tensile Stress due to climate

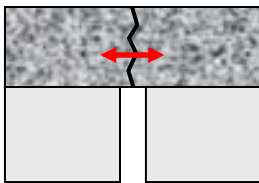
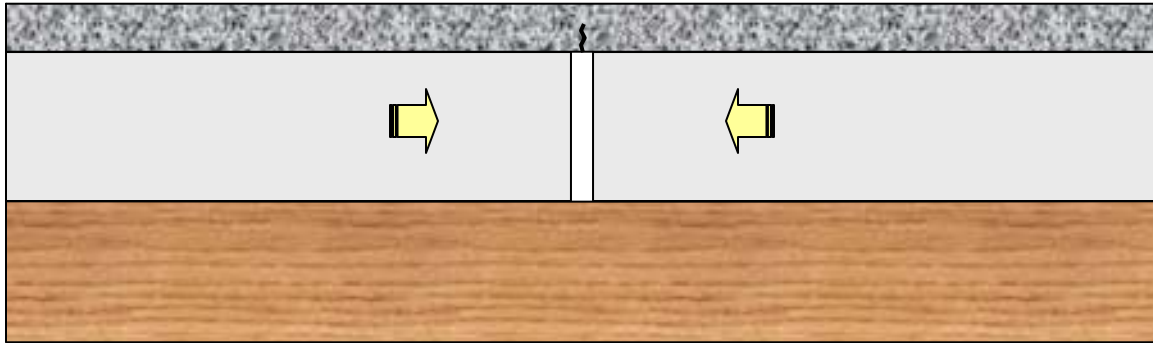

Mode 3: Horizontal Tensile Stress due to climate



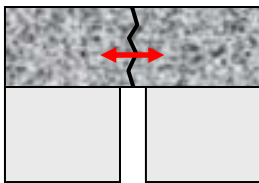
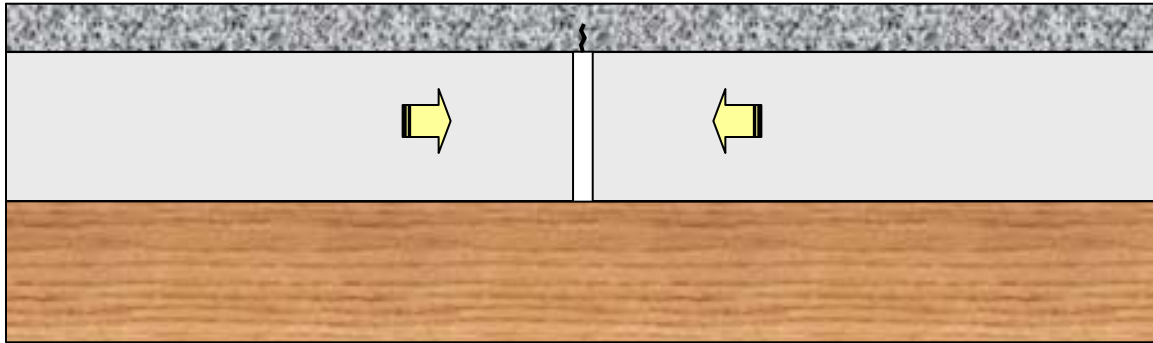

Mode 3: Horizontal Tensile Stress due to climate

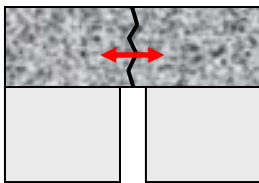
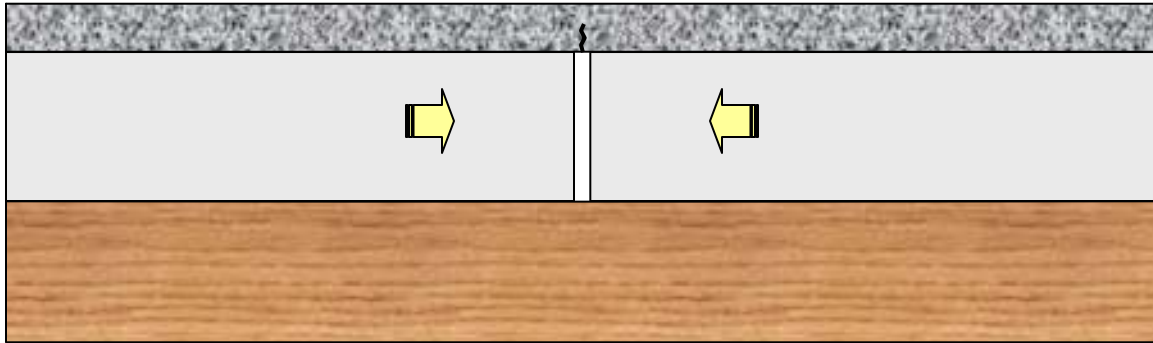

Mode 3: Horizontal Tensile Stress due to climate



**“Over many cycles...”**

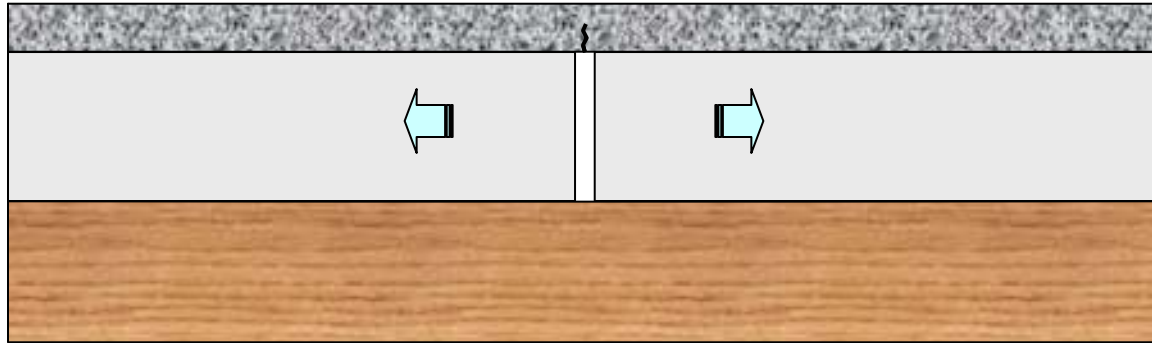

Mode 3: Horizontal Tensile Stress due to climate



**“Over many cycles...”**

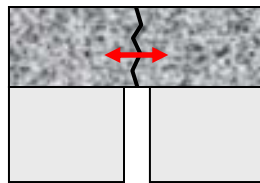
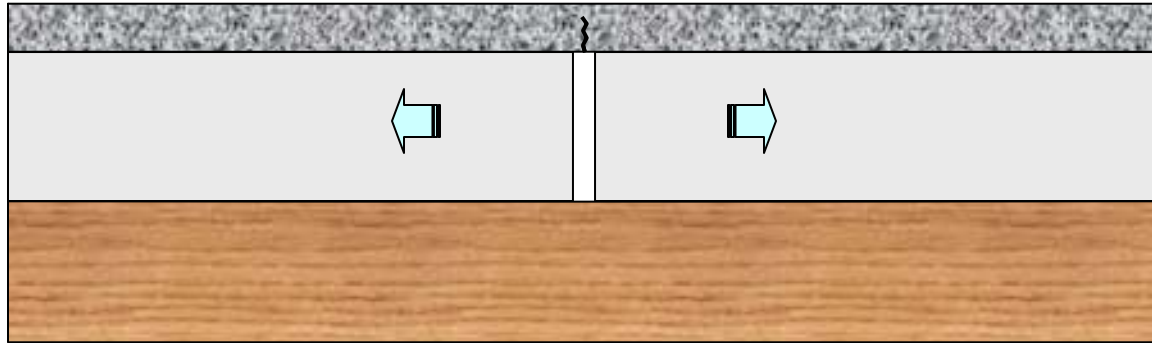

Mode 3: Horizontal Tensile Stress due to climate



**“reflection cracks develop.”**

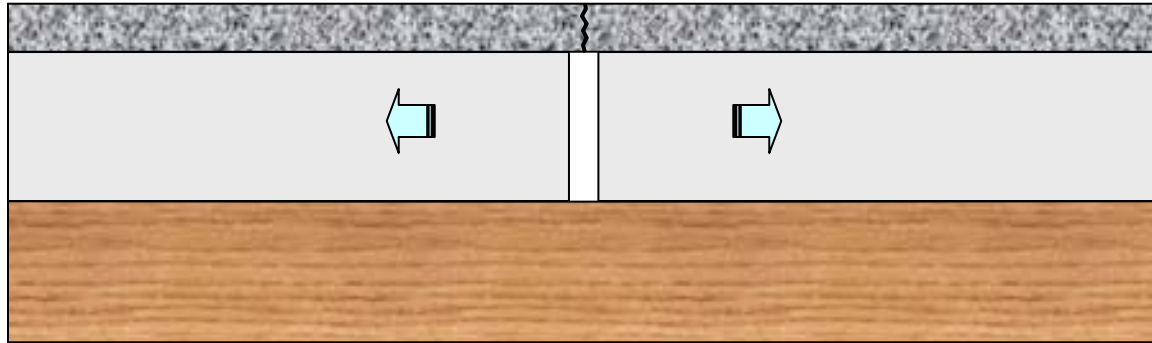

Mode 3: Horizontal Tensile Stress due to climate



**“reflection cracks develop.”**

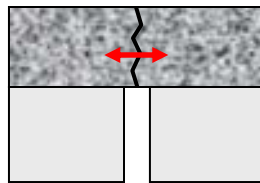
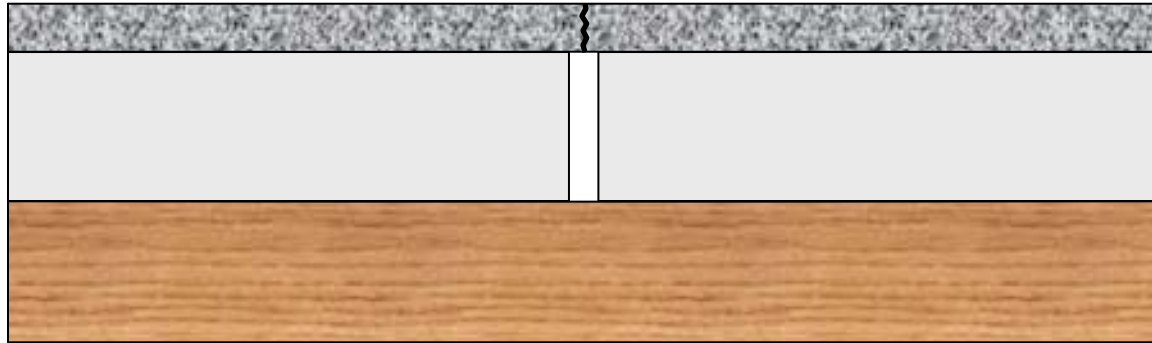

Mode 3: Horizontal Tensile Stress due to climate

# The Solution

## Reflective Crack Relief Mixtures

- RCRI and RBL
  - Thin (1”) fine aggregate HMA
  - Highly elastic binder – modified on low PG side as well (-28°C and lower)
  - Asphalt-rich, impermeable layer to keep moisture away from PCC and supporting materials

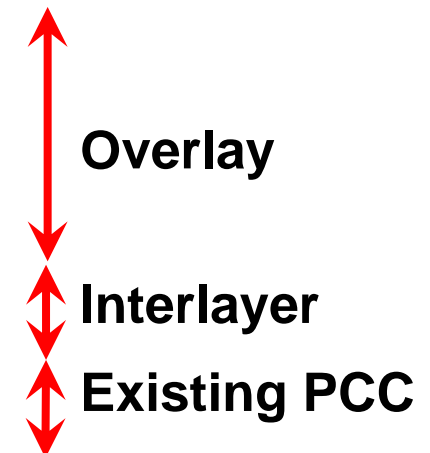
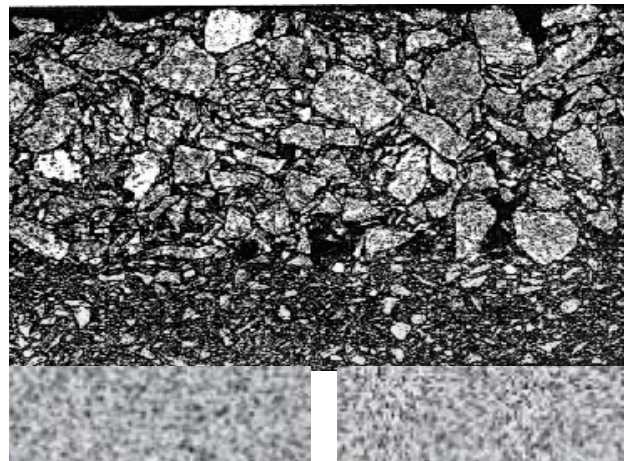

# Fatigue Life Comparisons

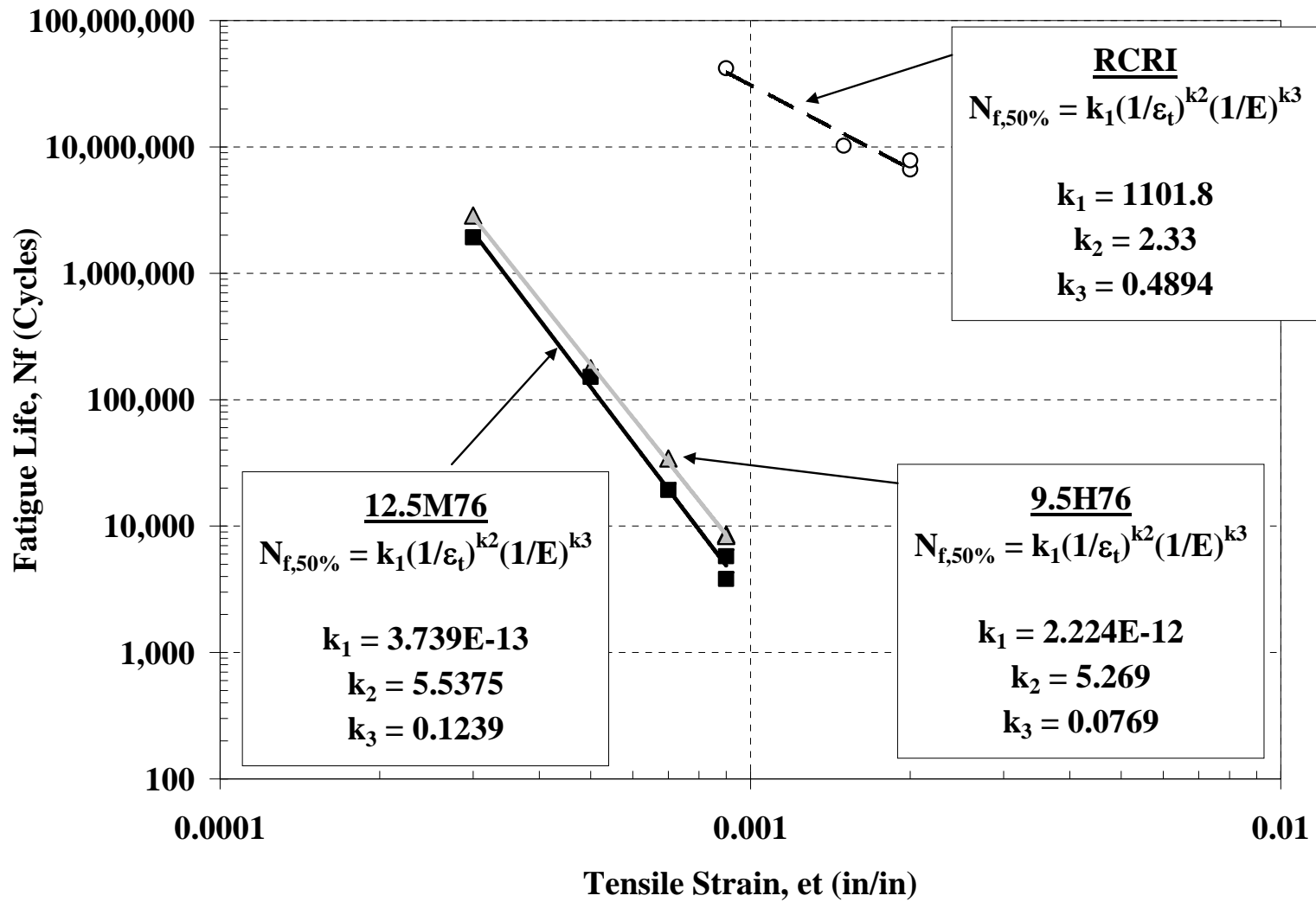



# Successful\* Mitigation Methods

(Bennert and Maher, TRB 2007)

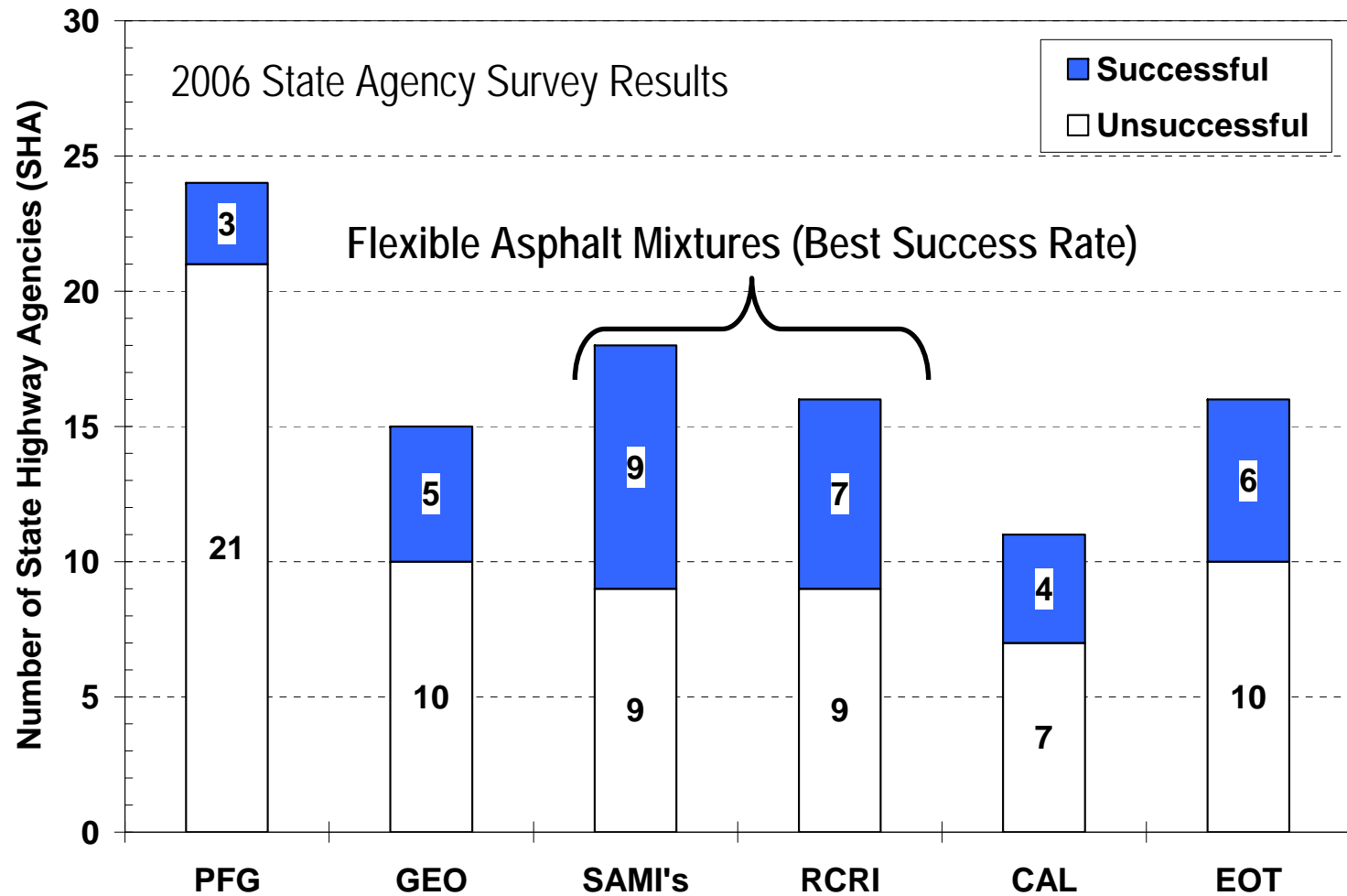

\*Greater than 4 Years Before Cracking Observed

# Paving Fabrics to Mitigate Reflective Cracking

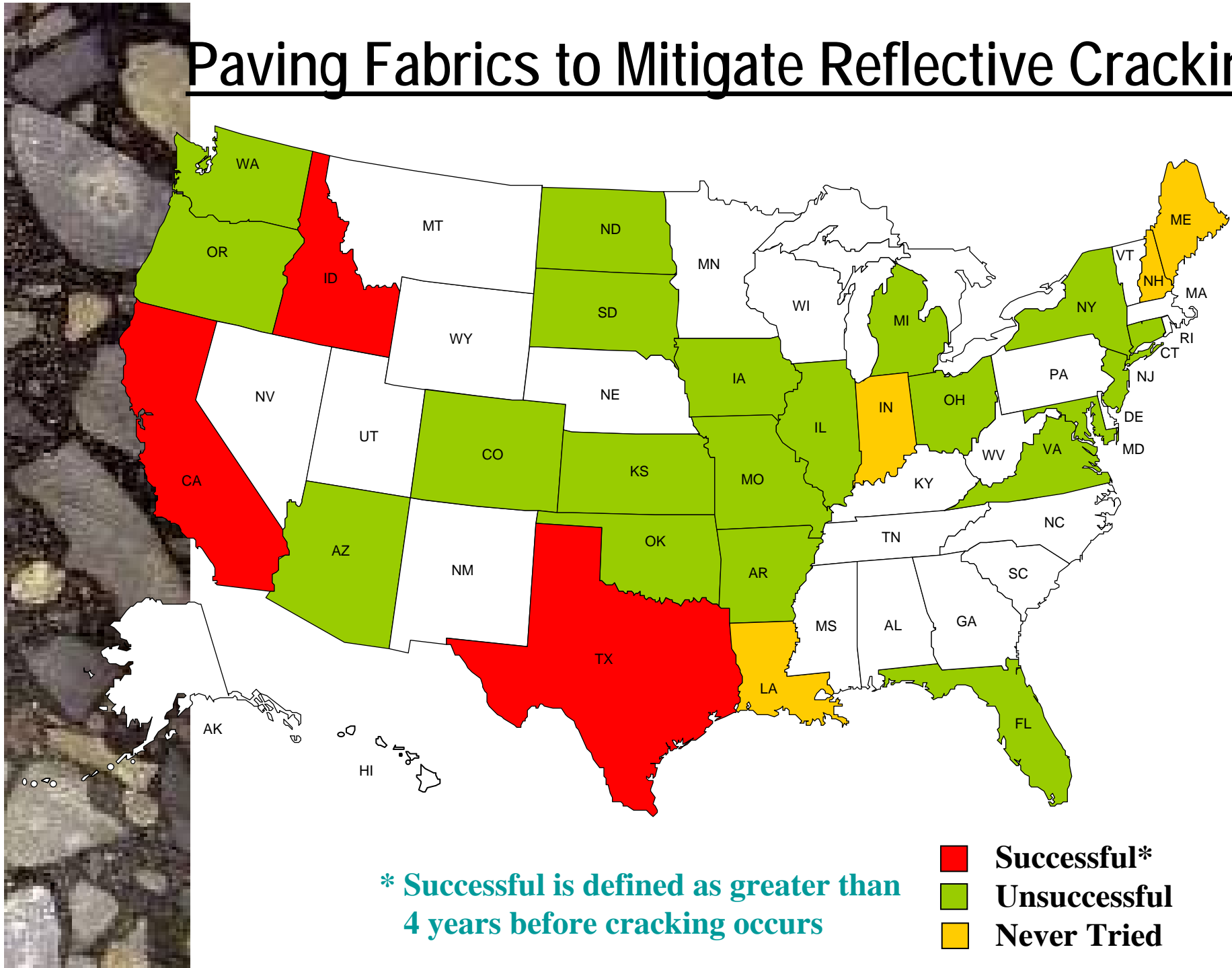



# Quick Note on Paving Fabrics

- Work well for HMA pavements when additional structural support needed
  - i.e. – can not increase pavement thickness but need more support
- Due to horizontal movement of PCC, fabrics stretch and HMA still cracks
  - Not recommended for PCC/Composite pavements



# RCRI Test Section (Rt 34N)

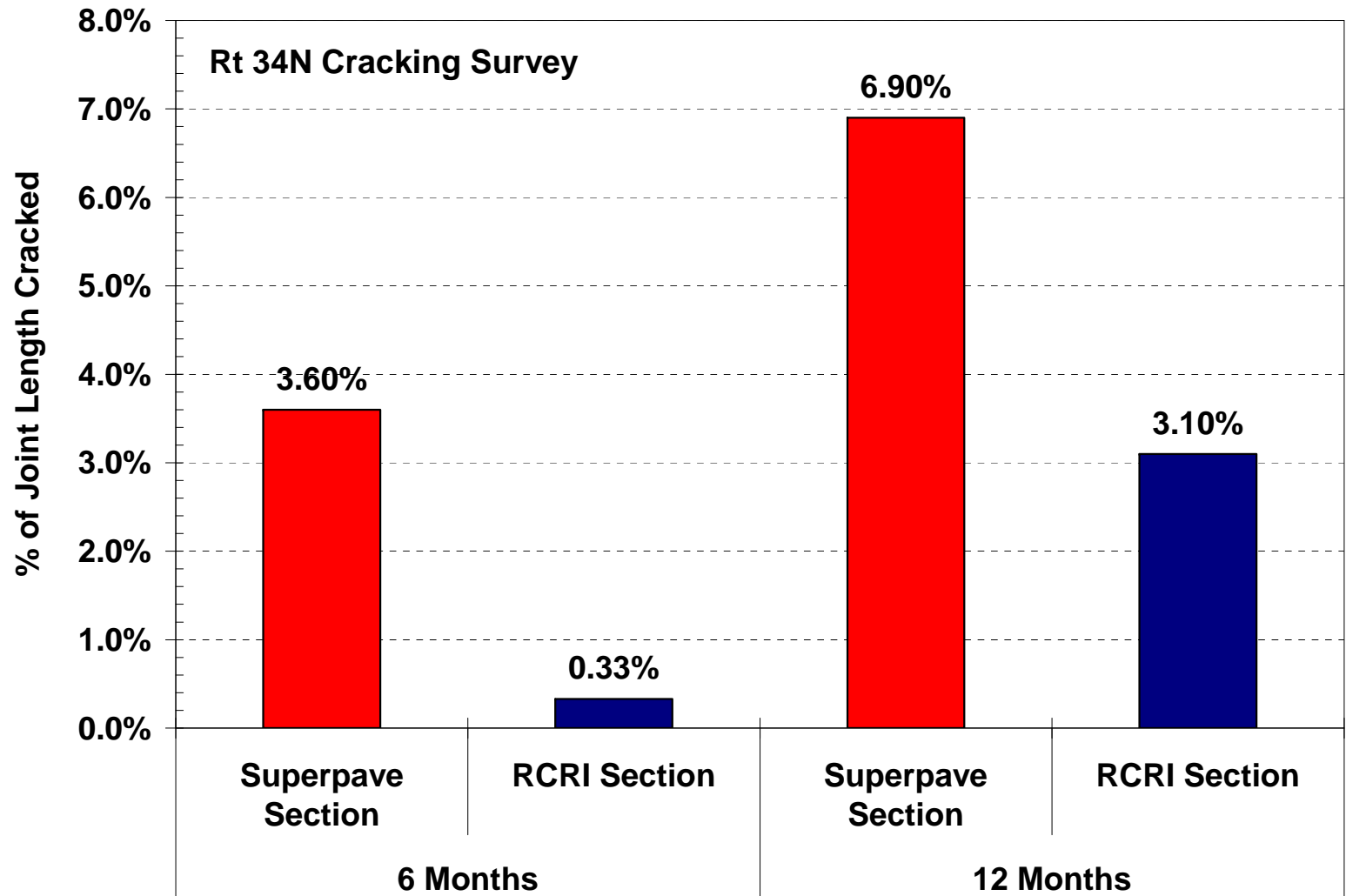

**Why do we still get cracking with a “crack relief interlayer”?**

# “Crack Jumping”

- Occurs in HMA materials that overlay highly elastic stress absorbing interlayers
  - No cracking in RCRI – crack initiates above RCRI
  - Issues with stiffness/fatigue compatibility
- The interlayers only absorb a percentage of the vertical stress/strain, not eliminate it
  - At specified thickness, it almost completely eliminates the horizontal

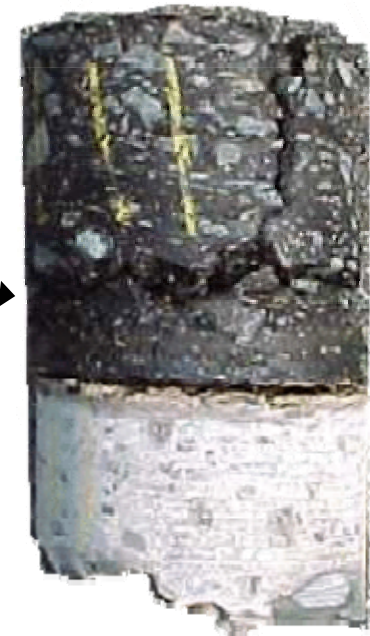

**1.5" of 12M76**



**0.5" of RCRI: 1.5" of 12M76**



**5 Cycles**

**278 Cycles**

**1.0" of RCRI: 0.5" 12M76**



**0.035" Opening  
15°C (59°F)**

**> 2,800 Cycles**



# Current Methodology for Composite Pavements

- Rutgers University developed an analytical method to predict the performance of asphalt mixtures on composite pavements
  - “Deflection Spectra Approach”
  - Takes into account both horizontal and vertical movements
  - Realistic asphalt mixture response (over 15 mixtures sampled from field and tested)
- Developed simplified Excel Spreadsheet to optimize HMA mixture selection
- NJDOT evaluating now – still “Experimental”



# Example #1: 4" Thick HMA; 15 ft PCC Slab Length

## NJDOT HMA Overlay Selection Program

Step 1 - Determining appropriate HMA material to be placed directly over PCC to limit cracking due to horizontal deflection

**Horizontal Fatigue Life (Cycles)**

Strata	RBL	HPTO	9.5mm SMA (76-22)	9.5H76	12H76	12M64
76168	15927	18047	20939	9295	672	2259
PASS	PASS	PASS	PASS	PASS	FAIL	PASS

CTE (in/in/C)	1.15E-05
HMA Overlay Thickness (in)	4
PCC Slab Length (in)	180
Temp at Bottom of HMA (°F)	50

Step 2 - Determine Appropriate HMA Material to be placed directly over PCC to limit cracking due to vertical deflection

**Vertical Fatigue Life (Years)**

Strata	RBL	HPTO	9.5mm SMA (76-22)	9.5H76	12H76	12M76
1750.2	23.4	19.2	15.4	2.1	0.6	5.6
PASS	PASS	PASS	PASS	FAIL	FAIL	FAIL

ESAL's per Year	1.50E+05
FWD Vertical Deflection at 18 Kips (mils)	8
-OR-	
PCC Condition (Good, Avg, Poor)	Good

Step 3 - Determine Optimum HMA Overlay

**Vertical Fatigue Life (Years)**

Strata	RBL	HPTO	9.5mm SMA (76-22)	9.5H76	12H76	12M76
4266.7	121.9	102.1	150.5	13.2	2.4	47.1
PASS	PASS	PASS	PASS	PASS	FAIL	PASS

**Requested Design Life to Limit Cracking (Years)** 10

Summary Matrix

Select optimum PCC overlay and Select HMA Overlay

	Strata	RBL	HPTO	9.5mm SMA (76-22)	9.5H76	12H76	12M76
PCC Overlay (Horizontal)	PASS	PASS	PASS	PASS	PASS	FAIL	
PCC Overlay (Vertical)	PASS	PASS	PASS	PASS	FAIL	FAIL	FAIL
HMA Overlay	PASS	PASS	PASS	PASS	PASS	FAIL	PASS





# Example #2: 4" Thick HMA; 78 ft PCC Slab Length

## NJDOT HMA Overlay Selection Program

Step 1 - Determining appropriate HMA material to be placed directly over PCC to limit cracking due to horizontal deflection

Horizontal Fatigue Life (Cycles)

Strata	RBL	HPTO	9.5mm SMA (76-22)	9.5H76	12H76	12M64
1378	287	198	166	21	24	7
PASS	FAIL	FAIL	FAIL	FAIL	FAIL	FAIL

CTE (in/in/C)	1.15E-05
HMA Overlay Thickness (in)	4
PCC Slab Length (in)	936
Temp at Bottom of HMA (°F)	50

Step 2 - Determine Appropriate HMA Material to be placed directly over PCC to limit cracking due to vertical deflection

Vertical Fatigue Life (Years)

Strata	RBL	HPTO	9.5mm SMA (76-22)	9.5H76	12H76	12M76
1750.2	23.4	19.2	15.4	2.1	0.6	5.6
PASS	PASS	PASS	PASS	FAIL	FAIL	FAIL

ESAL's per Year	1.50E+05
FWD Vertical Deflection at 18 Kips (mils)	8
-OR-	
PCC Condition (Good, Avg, Poor)	Good

Step 3 - Determine Optimum HMA Overlay

Vertical Fatigue Life (Years)

Strata	RBL	HPTO	9.5mm SMA (76-22)	9.5H76	12H76	12M76
4266.7	121.9	102.1	150.5	13.2	2.4	47.1
PASS	PASS	PASS	PASS	PASS	FAIL	PASS

Requested Design Life to Limit Cracking (Years) 10

Summary Matrix

Select optimum PCC overlay and Select HMA Overlay

	Strata	RBL	HPTO	9.5mm SMA (76-22)	9.5H76	12H76	12M76
PCC Overlay (Horizontal)	PASS	FAIL	FAIL	FAIL	FAIL	FAIL	
PCC Overlay (Vertical)	PASS	PASS	PASS	PASS	FAIL	FAIL	FAIL
HMA Overlay	PASS	PASS	PASS	PASS	PASS	FAIL	PASS

