

**UNDERWATER INSPECTION AND EVALUATION
OF
NEW JERSEY BRIDGES
GUIDELINES MANUAL**

Prepared for the

**STRUCTURAL EVALUATION
DIVISION OF DESIGN SERVICES**

June 1994
(Revised June 1997)
(Revised August 2008)

**Earth-Tech Consultants, Inc.
& Structural Evaluation**

CHAPTER 1	INTRODUCTION	
	1.1 Underwater Inspection.....	1
	1.2 Manual Contents.....	3
CHAPTER 2	TYPES AND CRITERIA OF UNDERWATER INSPECTION	
	2.1 Types of Underwater Inspection.....	4
	2.2 Criteria for Determining Type of Inspection.....	6
CHAPTER 3	PROCEDURES FOR TYPE 1 INSPECTION	
	3.1 Channel Plan and Cross Sections.....	13
	3.2 Inspection Forms	23
CHAPTER 4	PROCEDURES FOR DIVING (TYPE 2 OR 3) INSPECTIONS	
	4.1 Standard Scope of Work	30
	4.2 Qualifications of Divers and Inspectors	37
	4.3 Diving Report Format.....	39
CHAPTER 5	OTHER SPECIAL DIVING PROCEDURES	
	5.1 Underwater Photography.....	69
	5.2 Fathometer Survey	71
	5.3 Special Testing for Type 4 Inspections.....	73
CHAPTER 6	DIVING PROPOSAL FORMAT	
	6.1 Technical Proposal	75
	6.2 Cost Proposal	77
	6.3 Insurance and Other Requirements	78

APPENDICES

Appendix A	Reference Documents
Appendix B	Sample of Underwater Inspection Survey Report
Appendix C	Sample of Underwater Inspection Proposal Documents

CHAPTER 1 INTRODUCTION

Approximately 86% of all bridges nationwide span waterways according to FHWA statistics. A recent survey of bridge failures determined that over sixty percent were due to hydraulic related reasons. The need, therefore, to inspect and evaluate those portions of the bridge that are underwater, and therefore not readily apparent, is essential to maintain the structural integrity of the nation's bridges.

This condition was brought to light in the late 1980s with three highly publicized waterway bridge failures. In all three, the failure was in some way attributable to inadequacies in the underwater inspection procedures that were in place at the time. It was determined by the FHWA that the existing conditions were either inadequately inspected or not documented in sufficient detail to provide a warning of the potential problems. It was also determined that many waterway bridges have elements which pose a higher than normal potential for collapse. Additionally, due to the nature of these failures, a need for improved record keeping was found to be required.

In response to this need, the FHWA issued a Technical Advisory (T5140.21) to provide guidance on implementing changes to improve the underwater inspection of bridges. In addition, the FHWA issued a Manual on the subject titled Underwater Inspection of Bridges (Report No. FHWA-DP-80-1) in order to:

- provide guidance for underwater bridge inspection;
- acquaint those responsible for bridge safety with underwater techniques and equipment; and
- briefly present methods of repair for commonly found defects.

Additional information on the subject can also be found in the relevant chapters of the FHWA's Bridge Inspector's Reference Manual 2002 (Report No. FHWA-NHI-03-001).

1.1 UNDERWATER INSPECTION

Nearly all waterway bridges require an underwater inspection, which involves the inspection, evaluation and monitoring of the following:

- Physical condition of the substructure elements
- Physical condition of substructure protective devices
- Condition and location of streambed materials
- Condition and stability of the waterway channel
- Condition and stability of channel protective materials

CHAPTER 1 INTRODUCTION

A common misconception is that the underwater inspection of a bridge pertains only to the work performed by a diver. **However, for the majority of the bridges in New Jersey, an underwater inspection will not require a diver.** Most of the bridges can be accessed and evaluated by a wading inspection of the site using a probing rod, sounding rod or line, waders, and in some cases, a boat. The underwater inspection of these bridges, however, is no less important than those that require a diver.

At some bridges, due to the depth, clarity or current of the water or the conditions on the channel bottom, a diver is required to perform a visual evaluation of the condition of the structure's underwater elements. For these bridges, the FHWA, as part of the National Bridge Inspection Standard (NBIS), has adopted general classifications for the level of diving inspection. These classifications are based upon the extent of survey conducted and the measurements obtained and are determined by the physical conditions at the bridge site and the relative importance of the bridge in the transportation network.

The three levels of NBIS diving inspection and the general scope for each are:

Level I Inspection

A Level I inspection is generally defined as a "swim-by" overview inspection and includes a minimal amount of cleaning to remove marine growth. The inspection involves a close visual examination using large sweeping motions of the hands where visibility is limited to less than one foot by alluvial materials in the water. The inspection must be detailed enough to detect obvious major defects or deterioration of the structural elements due to overstress, damage or corrosion. The inspection is also utilized to confirm the continuity of the full length of all members and to detect undermining or exposure of normally buried elements.

A Level I inspection is comprised of an examination of the total exterior surface of each underwater element included within the scope of the work. This would typically include piers, abutments, retaining walls, bulkheads, fenders or pile bents. This inspection also involves a limited probing of the substructure and the adjacent streambed and an examination of the presence and physical condition of riprap or other scour countermeasures.

Level II Inspection

A Level II inspection is a more detailed inspection, which requires portions of the structure to be cleaned of marine growth. A Level II inspection is intended to detect and identify damaged and deteriorated areas that may be hidden by marine growth on the surface of the structural element. A limited amount of measurement at the damaged or deteriorated areas is included in the scope of a Level II inspection.

CHAPTER 1 INTRODUCTION

Cleaning is an often time consuming and expensive proposition and, therefore, should be restricted to critical areas of the structure. Selection of areas to be cleaned, however, should be made to minimize the potential for damage to the structure. General guidelines for the areas of an element that should be cleaned are given in the FHWA Manual titled Underwater Inspection of Bridges and will be detailed in Chapter 4 of this Manual.

Level III Inspection

A Level III inspection is a highly detailed inspection of a critical structural element in which extensive repair or possible replacement may be warranted. This level of inspection typically would include nondestructive testing of the material, such as using ultrasonics, but could include more extensive testing, such as coring of wood or concrete and material sampling. Extensive cleaning of the critical areas and detailed measurements of damage or loss of sectional area would also be included. Because of the expensive nature of this type of inspection, its use is generally limited to key structural areas which may be representative of the whole structure or are suspected of being in distress.

1.2 MANUAL CONTENTS

This set of underwater inspection guidelines has been prepared for the State of New Jersey Department of Transportation to establish the minimum procedures that will be utilized during the NBIS bridge inspections. Chapter 2 provides descriptions of the various types of underwater inspection that may be performed on New Jersey's bridges and the criteria for determining their applicability. Chapter 3 provides the procedures and requirements for a Type-1 inspection, which does not require a diver. This includes channel cross sections and inspection forms for the waterway and substructure elements subjected to scour. Chapter 4 provides the standard scope, procedures, technical qualifications and documentation requirements for diving type inspections. In Chapter 5, other special procedures, which may be required in special diving inspection situations, will be discussed. The proposal format and requirements for a diving type inspection are given in Chapter 6, and reference documents and a sample diving report are in Appendices A and B.

CHAPTER 2
TYPES AND CRITERIA OF UNDERWATER INSPECTION

2.1 TYPES OF UNDERWATER INSPECTION

The following standard classifications of underwater inspection types have been developed and will be utilized by the Department for the underwater inspection of New Jersey's bridges. (The percentage values refer to the number of underwater substructure elements inspected).

<u>Type of Inspection</u> (NJDOT)	<u>General Requirements</u>
Type-1	Does not require a diver. Channel cross sections and evaluation of waterway, channel & substructure elements for scour.
Type-2	Routine NBIS Diving Inspection (100% NBIS Level I and 10% NBIS Level II).
Type-3	In-depth Diving Inspection (100% NBIS Level I and >10% NBIS Level II)
Type-4	NBIS Level III Diving Inspection

The general scope of work which will be utilized during each of these types of inspection is given below. A bridge, however, could have more than one type of inspection depending upon the particular conditions found at its substructure elements.

2.1.1 Type-1 Inspection

A Type-1 Underwater Inspection will generally be performed on all waterway bridges as part of a routine NBIS biennial inspection. The specific requirements for this type of inspection are provided in Chapter 3. In addition to the inspection of the physical conditions of the bridge's substructure elements, which can be typically accessed by wading and performed using a probing rod, sounding rod or line, waders and possibly a boat, this type of inspection will also include the following:

1. Obtaining channel soundings and documenting the overall channel location and specific streambed location relative to the substructure.
2. Evaluating and documenting the physical conditions of the waterway and channel.
3. Evaluating the physical conditions of the streambed at each of the substructure elements potentially susceptible to scour.

CHAPTER 2

TYPES AND CRITERIA OF UNDERWATER INSPECTION

2.1.2 Type-2 Diving Inspection (Routine NBIS)

A Type-2 Underwater Inspection will generally be performed on all waterway bridges which have substructure elements which cannot be adequately inspected by a wading inspection. For these bridges, a diver is required to adequately determine the structural integrity of the bridge's substructure elements. The normal reasons a Type-2 inspection would be required include the depth, clarity or velocity of the water adjacent to the substructure elements.

The specific requirements for this type of inspection are provided in Chapter 4 of this Manual. This type of inspection, which is typically called a routine NBIS diving inspection, will include the following for each substructure element identified:

1. An NBIS, Level I, "swim-by" overview inspection on all the underwater elements of the structure.
2. An NBIS, Level II, more detailed inspection of approximately 10% of the underwater substructure elements including the cleaning of marine growth and limited measurement at damaged or deteriorated areas.
3. An inspection and probing of the channel bottom and areas adjacent to the substructure for signs of scour and deterioration of riprap or other countermeasures.

2.1.3 Type-3 Diving Inspection

A Type-3 Underwater Inspection is a more in-depth inspection and will generally be performed on waterway bridges where one of the following reasons is applicable:

- Inconclusive results for the Type-2 Inspection.
- A critical or major structure whose loss could have significant impact on life, property or the transportation network.
- Prior evidence of structural distress or scour related problems.

The general requirements of this type of inspection will be similar to those provided for a Type-2 Inspection and are given in Chapter 4 of this Manual. The one significant exception is that the extent of the NBIS Level II inspection of the underwater substructure elements will be more extensive than 10%, and the elements and extent need to be specifically defined. Type-3 inspection will include the following for each substructure element identified:

1. An NBIS, Level I, "swim-by" overview inspection on all underwater elements of the

CHAPTER 2

TYPES AND CRITERIA OF UNDERWATER INSPECTION

structure.

2. An NBIS, Level II, more detailed inspection of the specifically defined areas (greater than 10%) of the underwater substructure elements, including the cleaning of marine growth and limited measurement at damaged or deteriorated areas.
3. An inspection and probing of the channel bottom and areas adjacent to the structure for signs of scour and deterioration of riprap or other countermeasures.

2.1.4 Type-4 Diving Inspection

A Type-4 Inspection is a highly detailed inspection of a critical structural element that may warrant extensive repair or possible replacement. A Type-4 Inspection will be required when there is evidence of the potential need for priority repairs, based upon the results found during a Type-2 or Type-3 inspection. The scope for a Type-4 inspection will typically include the following for each substructure element identified:

1. An NBIS, Level III, highly detailed inspection on a specifically defined element or portion of an element. This will also include extensive cleaning of marine growth and detailed measurements of the damaged or deteriorated areas.
2. Nondestructive or partially destructive testing of a portion of a specifically defined critical element.
3. Underwater photography (either still or video).

Information on underwater photography and some of the testing procedures that may be utilized is located in Chapter 5.

2.2 CRITERIA FOR DETERMINING TYPE OF INSPECTION

The following are the standard criteria that should be used to determine the type of inspection required for each bridge. As stated earlier, more than one type of inspection may be required on a bridge, depending upon the particular conditions found at its substructure elements.

2.2.1 Type-1 Inspection

In general, the following standard criteria should be used to determine if a bridge should receive a Type-1 Underwater Inspection:

1. *The bridge should span a waterway.*

CHAPTER 2

TYPES AND CRITERIA OF UNDERWATER INSPECTION

This should include those structures which span waterway channels that may be dry during any particular inspection cycle.

2. *The structure should have substructure elements which are within the limits of the 500 Year storm or event.*
3. *The substructure elements of the structure should be affected by the flow of water.*

All structures that have a waterway that is contained within a confined channel except for periods of very heavy floods (>100-year event) will be eliminated. The confined channel should be independent from the bridge or such that it prevents the flow of water from affecting the stability of the substructure elements. This does not necessarily include box culverts or those structures where a concrete slab has been placed between the abutments, since they are potentially vulnerable to lateral stability problems of the upstream channel and local scour, particularly at the outlet.

2.2.2 Type-2 Diving Inspection (Routine NBIS)

In general, the following standard criteria should be used to determine if a structure (or specific elements of the structure) should receive a Type-2 inspection.

1. *The bridge should be eligible for a Type-1 Inspection.*
2. *The bridge should have elements whose structural safety cannot be adequately determined with the normal wading inspection procedures.*

In general, several items will limit the ability of the inspector to perform a visual evaluation.

Depth of Water During Periods of Low Flow

An inspector can typically walk in water which is three feet in depth when currents are not excessive. When the water at a substructure element is greater than three feet, and the water is not clear enough to visually inspect the elements physical conditions, a diver may be necessary. Inspections of bridges crossing tidal channels that have normal fluctuations should be inspected (if possible) when the channel is at a low level.

CHAPTER 2

TYPES AND CRITERIA OF UNDERWATER INSPECTION

Clarity of Water

In addition to depth, the clarity of the water that is adjacent to a substructure element will have an impact on the ability of the inspector to perform a visual evaluation. In these cases, it may be necessary to utilize a diver to perform a tactile inspection of the underwater element.

Current of the Water

Even if the depth is not greater than three feet, the current may affect the ability of the inspectors to safely perform their evaluation. Similar to depth, however, the inspection may be possible at other times, if the current is subject to fluctuations. A diver will be required at those substructure elements where excessive current is a safety issue during the inspection.

Channel Bottom Conditions

Similar to current, the condition of the channel bottom may also be a safety issue during the performance of a wading inspection. Channel bottoms that are soft or slippery may be dangerous to inspect even if the water is not greater than three feet. In some of these locations, a boat can be used to perform the evaluation. However, a diver may be required if clarity or current is also an issue.

The frequency interval of a Type-2 Underwater Inspection can vary from 12 to 48 months depending upon the following:

- Age of the Structure
- Type of Substructure Materials
- Substructure Configuration
- Adjacent Waterway Features
- Susceptibility of Streambed Materials to Scour
- Maintenance History
- Saltwater Environment
- Waterway Pollution
- Damage due to Waterborne Traffic, Debris or Ice

In general, if there are conditions at a bridge which, due to existing or prior problems or potential vulnerability to scour, make an inspection every four years inadequate to check its structural safety, then a frequency of two years should be recommended. For example, for steel substructure elements located in corrosive environments, the American Association of State Highway and Transportation Officials (AASHTO) recommends a

CHAPTER 2

TYPES AND CRITERIA OF UNDERWATER INSPECTION

maximum underwater inspection interval of two years. The scope for the inspection at a minimum, however, should be the same regardless of the frequency. If the reason for the increased frequency is due to existing problems or the potential for priority repairs, then a Type-3 or Type-4 Inspection may be warranted.

The frequency referred to above is for a normally scheduled diving inspection. Certain conditions and events may require a bridge receive a special inspection. These can include:

- Unusual Floods
- Vessel Impact
- Unusual Ice Flows
- Evidence of Deterioration or Movement

If any of the above are observed during the field inspection, or are known to have occurred, the Department should be notified; a revision to the inspection frequency for the bridge may be warranted.

2.2.3 Type-3 Diving Inspection

The main consideration in determining whether a Type-3 Inspection is warranted is the amount of marine growth on the underwater elements of the bridge and the potential benefits derived from a more in-depth inspection. In addition, if one or more of the following standard criteria (as illustrated in Figure 2-1) are met, a structure (or specific elements of the structure) should be considered for receiving a Type-3 Inspection:

1. *The results of the Type-2 Inspection were inconclusive and additional work is necessary to verify the structural integrity of the bridge.*
2. *The bridge is considered a "critical" facility as defined in FHPM Volume 6, Chapter 10, Section 2. (These bridges should be identified in the SI&A Record as those having an asterisk in the 25th position of Item Number 6.)*
3. *The bridge is considered a "major" facility and meets the additional criteria related to the potential for scour and/or substructure condition problems.*

A "major" facility is defined as one which meets at least one of the following:

- A structure located on the National Highway System (NHS) which has a length of greater than or equal to 200 feet and an ADT of at least 20,000.
- A structure located on the NHS which has a length of greater than or equal to 100 feet and an ADT of at least 50,000.

CHAPTER 2
TYPES AND CRITERIA OF UNDERWATER INSPECTION

METHOD OF DETERMINING BRIDGES FOR
TYPE 3 DIVING INSPECTION

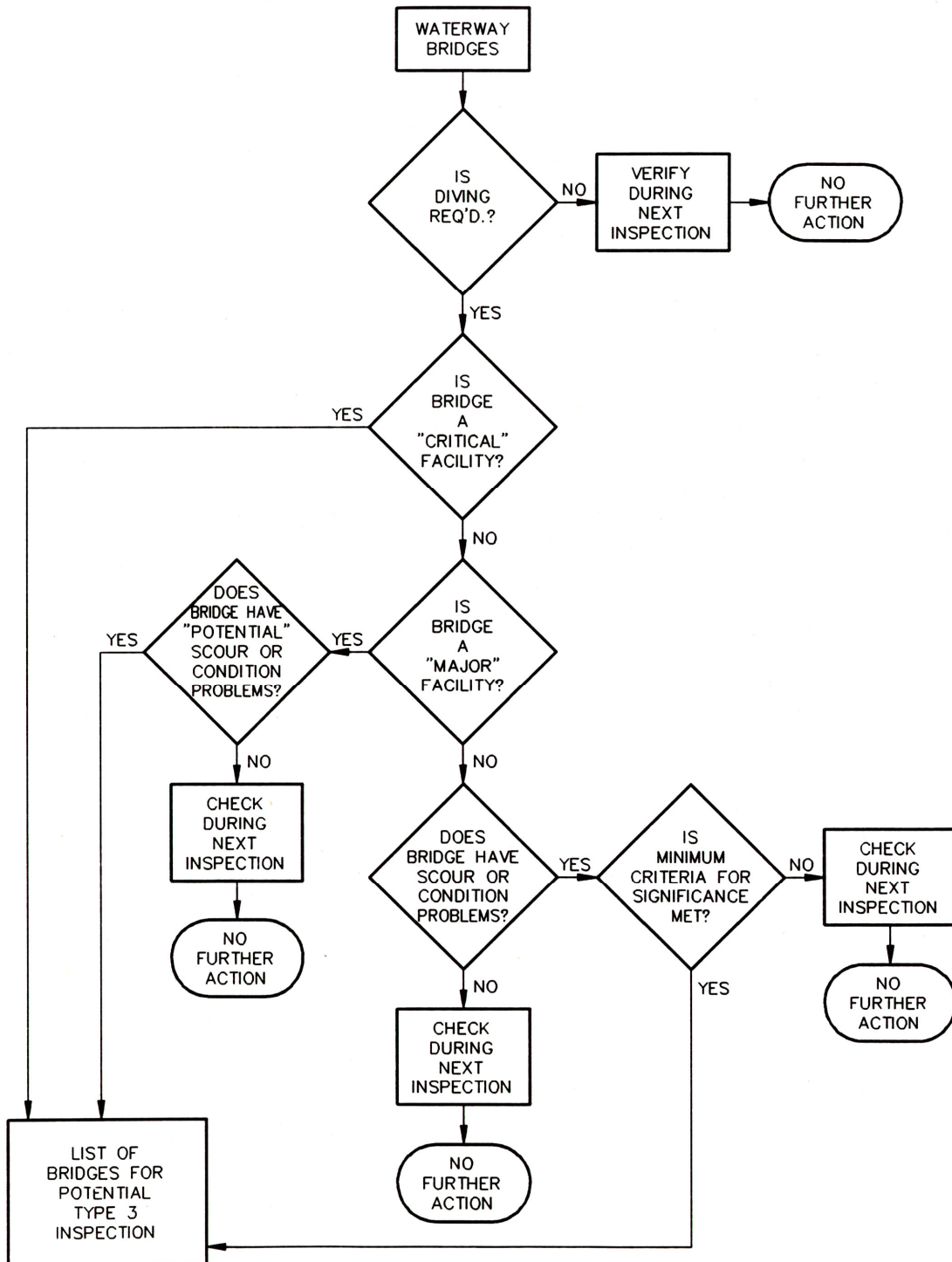

Figure 2-1

CHAPTER 2

TYPES AND CRITERIA OF UNDERWATER INSPECTION

- A structure which has a total length of greater than or equal to 500 feet and an ADT of at least 20,000.
- A structure located on a dead end road with an ADT of at least 10,000.
- A structure with a bypass detour length greater than 10 miles and an ADT of at least 20,000.

In addition, at least one of the following criteria related to its potential structural condition and vulnerability to scour should apply:

- A substructure condition rating (SI&A Item 60) of no higher than 5 (fair), providing the rating is due to underwater element deficiencies.
- The bridge is evaluated to be 'scour critical' (SI&A Item 113 = 3 or less).
- The bridge is not yet fully evaluated for 'scour critical' status (SI&A Item 113 = 6, T or U).

4. *A bridge that has current scour related or substructure deficiencies and meets one or more of the following criteria related to its significance in the transportation network.*

A bridge is defined as having current scour related or substructure deficiencies if at least one of the following apply:

- A substructure condition rating (SI&A Item 60) of no higher than 4 (poor), providing the rating is due to underwater element deficiencies.
- The bridge is evaluated to be 'scour critical' (SI&A Item 113 = 3 or less) and there is scour present.
- The bridge is not yet fully evaluated for 'scour critical' status (SI&A Item 113 = 6, T or U) and there is scour present.

In addition, at least one of the following criteria related to its significance to the transportation network should apply:

- A structure which is located on a non-local classification roadway and has an ADT of at least 10,000.
- A structure which is located on a dead end roadway and has an ADT of at least 3,000.

CHAPTER 2

TYPES AND CRITERIA OF UNDERWATER INSPECTION

- A structure which has a bypass detour length of at least 10 miles and has an ADT of at least 5,000.

Final determination, however, will be based upon the Department review of the potential benefits derived from this more in-depth inspection.

2.2.4 Type-4 Inspection

In general, the following standard criteria should be used to determine if a structure (or elements of a structure) should receive a Type-4 Inspection.

1. *The results of the Type-3 Inspection were inconclusive and additional work is necessary to verify the structural integrity of the bridge.*
2. *Priority repairs are required to the underwater portion of the substructure and additional information is required to determine the extent or scope of the repairs.*

Final determination, however, will be based upon the Department's review and will be primarily due to the potential severity of the defect.

CHAPTER 3

PROCEDURES FOR TYPE 1 INSPECTION

As defined in the previous Chapter, a Type-1 Underwater Inspection is typically performed without a diver as part of an NBIS biennial bridge inspection. The NBIS biennial underwater inspection includes an evaluation and documentation of the physical conditions and structural integrity of the substructure elements.

For those waterway bridges requiring a Type-1 Underwater Inspection (according to the criteria given in Chapter 2), the following will also be included:

- Obtaining channel soundings and preparing or updating a channel plan and cross sections (as described below in Section 3.1 of this Chapter)
- Evaluating and documenting the physical conditions of the waterway and channel (as described in Section 3.2.1 of this Chapter on the WATERWAY/CHANNEL inspection form)
- Evaluating and documenting the physical conditions of the streambed at each of the substructure elements potentially vulnerable to scour (as described in Section 3.2.2 of this Chapter on the SUBSTRUCTURE/SCOUR inspection form)

The documentation and evaluation of the above items are critical since their conditions will often identify potential problems of stream stability and scour at the bridge. The following sections of the Chapter provide the scope and format for this documentation. The referenced documents, listed in Appendix A of this Manual, will provide additional information and guidance for the evaluation of these waterway issues.

3.1 CHANNEL PLAN AND CROSS SECTIONS

As noted above, the cross sections and plan of the channel are an important part of the documentation of the inspection of waterway bridges. This information is necessary to document long term changes in the location of the channel and can also help identify potential problems due to degradation and aggradation at the site.

This section of the Manual will outline the data which must be collected during a Type-1 underwater inspection and the format for its documentation. Three types of documentation, which may be required at a bridge, are:

- Initial or Baseline Drawings - Plan and Cross Sections
- Updated Plan and Cross Sections
- Substructure Profiles (as required)

CHAPTER 3 PROCEDURES FOR TYPE 1 INSPECTION

A description of the general requirements and formats which are applicable to all three types of documentation is given below. This is followed by a description of the extent and nature of the data which is required for each of the three individual types of documentation.

As discussed in the previous Chapter, the term waterway bridge includes those structures which span waterway channels which may be dry during any particular inspection cycle.

3.1.1. General Requirements

For the purposes of a Type-1 Underwater Inspection, the following documentation, which is in two parts, is included:

- A plan view of the bridge which contains the basic configuration of the channel and includes the data or soundings taken during the course of the inspection may be required if specified. The table of sounding depths shown on page 19 is required even if the plan view is not required.
- Scaled cross sections showing the location of the channel and its relationship to the bridge footings or other structural supports is always required.

This documentation is required for the full length of the waterway bridge and cross sections are required along both fascias. In certain situations, however, it may not be necessary for the full length of the bridge to be documented. For example, an exception maybe a long viaduct type structure crossing a waterway and having a large number of its spans outside of the normal flow channels. (However, this exception, as stated earlier, is not meant to exclude spans which may be dry at the time of the inspection but under other non-exceptional cases may be subjected to the flow of water and its resulting scour of material).

In addition to these minimum requirements, cross sections are also required along the longitudinal centerline of the bridge when the width of the bridge meets or exceeds four lanes of traffic or the bridge is on an abnormal skew. Other exceptions to the minimum requirements are when the aforementioned documentation does not adequately detail the problems or conditions found and/or additional sections or substructure profiles are required to show more critical conditions.

The completed plan and cross sections will be submitted as part of Appendix 3 (Drawings, Soundings and Photographs) or Appendix 5 Underwater Inspection of the Bridge Evaluation (or Re-Evaluation) Survey Report. The specific format and requirements of these two items are as follows:

CHAPTER 3 PROCEDURES FOR TYPE 1 INSPECTION

A. Plan (if specified by the Project Manager)

For each bridge that requires documentation, a plan view of the site is a requirement. The plan should be drawn at an approximate scale and should include, but not be limited to, the following:

1. General configuration of the channel and its relationship to the bridge opening.
2. The direction of flow.
3. The orientation of the piers and abutments.
4. Significant hydraulic related features such as areas of sedimentation, debris or scour related countermeasures.
5. Sounding data in a tabular form.

For most bridges, the plan should be shown on a letter size sheet. For long span bridges or viaducts, however, a ledger size sheet is also acceptable.

The location and spacing of the sounding data points is based upon a grid established for the bridge. The selection of the location of these sounding data, or reference points, should be established during the initial or baseline inspection. The dimensions for the sounding data should be measured from the established reference points to the bottom of the channel bed.

The reference for the data should be a fixed point on the bridge that would not normally be changed or lost and can be readily established during a subsequent inspection. For smaller bridges on wadable streams, the fixed point can be along the bottom of the fascia slab or beam. For other structures, the reference point can be at the top of the railing or parapet. However, if the railing or parapet is used, a typical dimension from the top of the deck or sidewalk to the reference point should also be given in case the railing or parapet is modified or removed.

The location of measurements should be taken starting adjacent to the abutment or pier (for cases where the full length of the bridge is not required) and proceeding along at a defined spacing. The spacing of the measurements should typically be at a range of ten to twenty feet. Measurements at the locations of all piers, within the limits of the portion of the bridge being documented, must be included. For all bridges a minimum of three intermediate points are required. For bridges with more than 10 spans, sounding measurements should be taken, as a minimum, at mid-span and at pier locations. As an alternative to a specific fixed dimension for the spacing of the soundings, fixed points on the structure (such as the location of diaphragms, railing posts or quarter points) can be utilized.

CHAPTER 3 PROCEDURES FOR TYPE 1 INSPECTION

The method or dimension of spacing chosen for the bridge should be clearly documented within the inspection report. The format for the plan and the documentation of the sounding data is provided in Fig. 3-1.

B. Cross Sections

Channel cross sections, based on the collected sounding data, should be plotted as part of the Type-1 Underwater Inspection procedures. Separate plots should be made for each of the individual cross section locations. The plots should maintain a constant orientation. The standard procedure will be to start with the upstream cross section and continue with each subsequent downstream cross section. The orientation of the two embankments, therefore, will be consistent for all cross sections.

The scale of the cross sections should be chosen so that, for most bridges, the data can be displayed on a letter sized page. For abnormally long or multi-span bridges, documentation on a ledger sized page is also acceptable. In addition, for other abnormal cases, such as at long bridges with shallow water depths, different horizontal and vertical scales can be used.

The cross section should include, but not be limited to, the following:

1. location of the footings (if the information is available)
2. general configuration of the substructure elements (including piles)
3. channel location based upon sounding data
4. relative elevation of the water at the time of the inspection

Elaborate details of the superstructure and/or the railings or parapets are not required unless they are necessary to improve the clarity of the channel and reference points used. An example of the format for the cross section is provided in Figure 3-2.

3.1.2. Initial or Baseline Drawings

An initial or baseline plan and cross sections are required at each waterway bridge. These drawings will typically be made during the first cycle inspection of the bridge, but can be made during a subsequent cycle if the data has not been previously documented according to the guideline procedures identified in this Manual.

**CHAPTER 3
PROCEDURES FOR TYPE 1 INSPECTION**

The purpose of this plan and set of cross sections is to establish the grid and reference point(s) as well as the base which will be utilized in the subsequent inspections. In addition, the location and size of the footings, if known, will also be documented on the cross section for comparison with the relative location of the adjacent streambed. These base drawings will be prepared once and then updated during the subsequent inspections.

Base drawings must be made using Intergraph Microstation (CADD) or MS Visio. The final submittal should also include a 3.5" (90 mm) diskette with the files for each individual plan and cross section clearly identified and referenced. A diskette for each individual bridge is not required.

The diskette should be clearly labeled with the consultant project identification information (if applicable), bridge numbers and names, as well as the route numbers and milepoints for State bridges and the county name for county owned structures.

Initial channel cross section location, changing features of the channel and information related to a particular inspection should be inputted on a separate level from the baseline information. The presentation of the drawings should be in general accordance with the preparation of final bridge design plan sheets as indicated in Section 8 of the Department's Design Manual for Bridges and Structures, and as defined in the table below.

LEVEL KEY FOR STREAM PLANS AND CROSS SECTIONS

<u>Element</u>	<u>Level</u>	<u>Line Style</u>
Border	51	Solid
Title Information	51	Text
Notes	52	Text
Permanent Features	53	Solid
Initial Soundings	54	Text
Initial Water Depth	54	Text
Initial Cross Section	55	Dashed
Initial Stream Plan	55	Dashed
Soundings	(X)	Text
Water Depths	(X)	Text
Cross Section	(X)	Solid
Plan	(X)	Solid

Notes:

CHAPTER 3 PROCEDURES FOR TYPE 1 INSPECTION

- (X) = Cycle No.
- Initial data is to be entered on both level 55 and (X).
- Year of inspection is to be included on level (X) as test and plotted with the other data on that level.
- Substructure profiles, if required, will follow a similar format.

3.1.3. Updated Plan and Cross Sections

During each subsequent inspection, the diskette containing the plan and each of the cross sections will be updated based on current field conditions. The updated files will include the initial, as well as the present, channel location on the cross sections. The channel location from each intermediate cycle inspection should not be plotted during each update unless it is necessary to help clarify a significant change in the channel since the prior inspection. The initial channel location, as well as any intermediate channel locations, should be shown as dotted lines and clearly labeled. An example of the format for an updated cross section is given in Figure 3-3.

3.1.4. Substructure Profiles (These drawings are not required unless specified by the Project Manager at the beginning of the project)

If scour problems are found during the field inspection which cannot adequately be documented using the channel cross sections, a substructure profile should be made. The typical use for this type of profile is to document the loss of material for the full length of a substructure unit. This documentation should be a scaled drawing with clear reference points and include the footing dimension and/or location. These profiles should be prepared utilizing Intergraph Microstation (CADD) or MS Visio in accordance with the procedures given above for the plan and cross sections. An example of the typical format for this profile is given in Figure 3-4.

CHAPTER 3
PROCEDURES FOR TYPE 1 INSPECTION

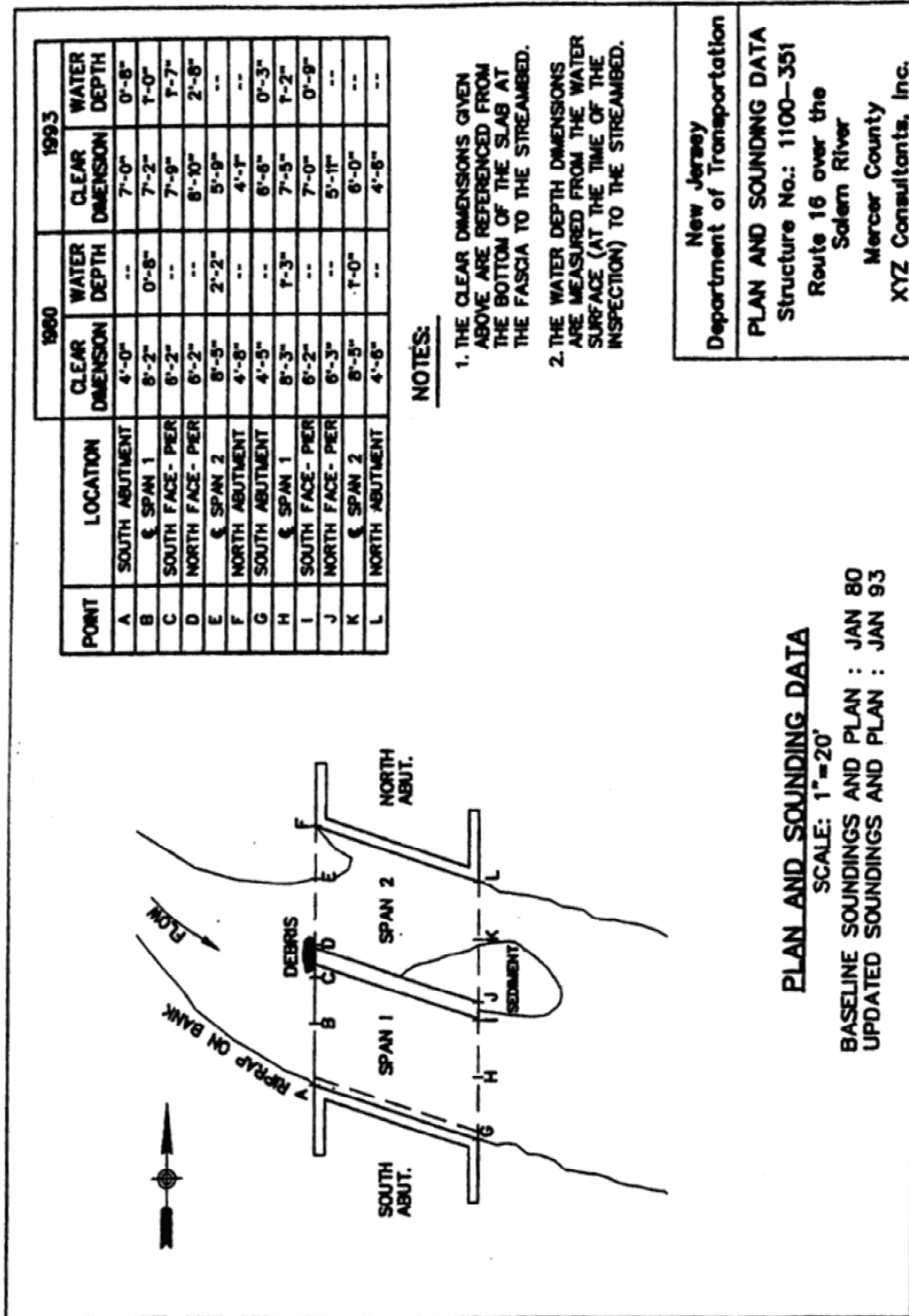

Figure 3-1

**CHAPTER 3
PROCEDURES FOR TYPE 1 INSPECTION**

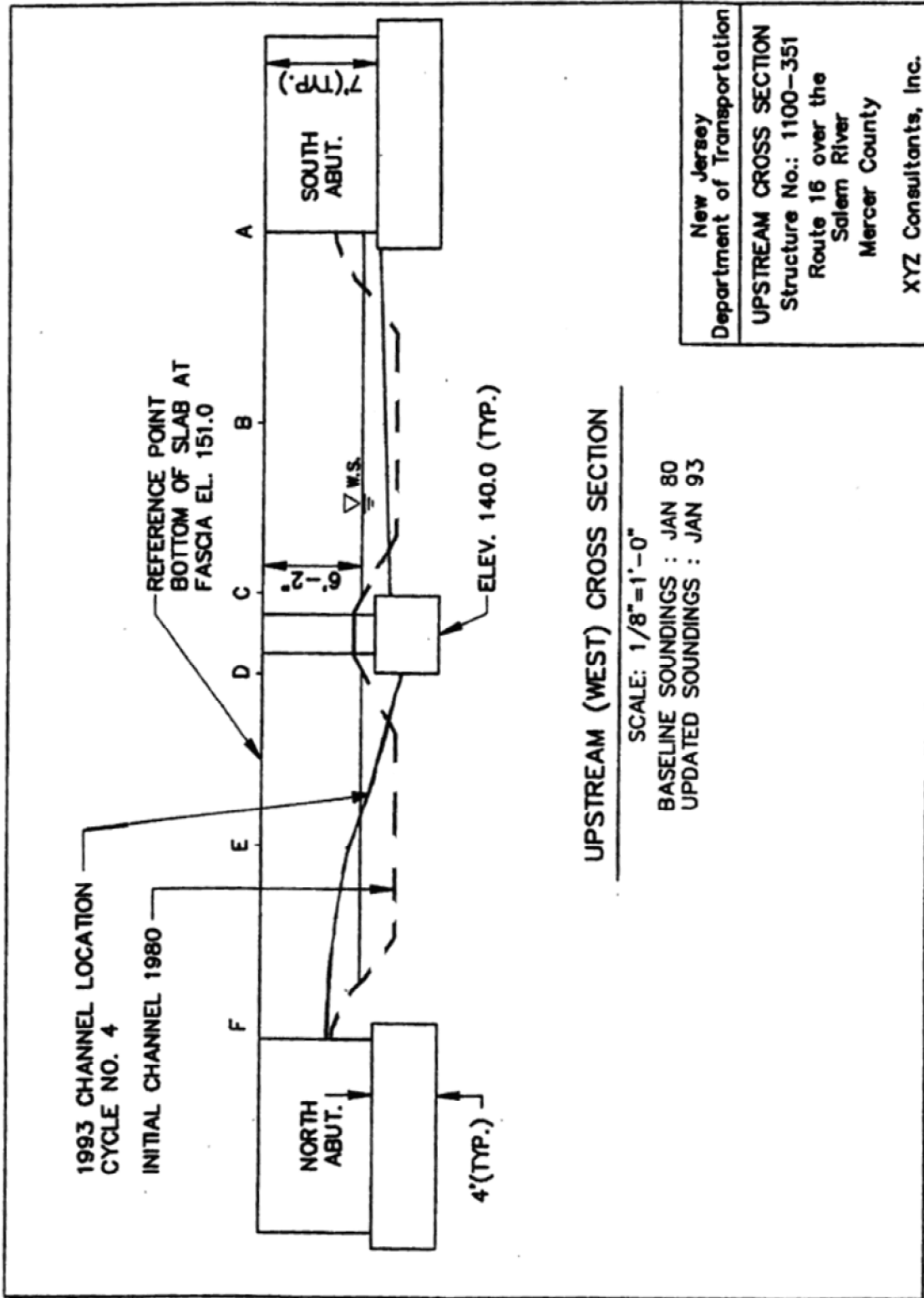

Figure 3-2

**CHAPTER 3
PROCEDURES FOR TYPE 1 INSPECTION**

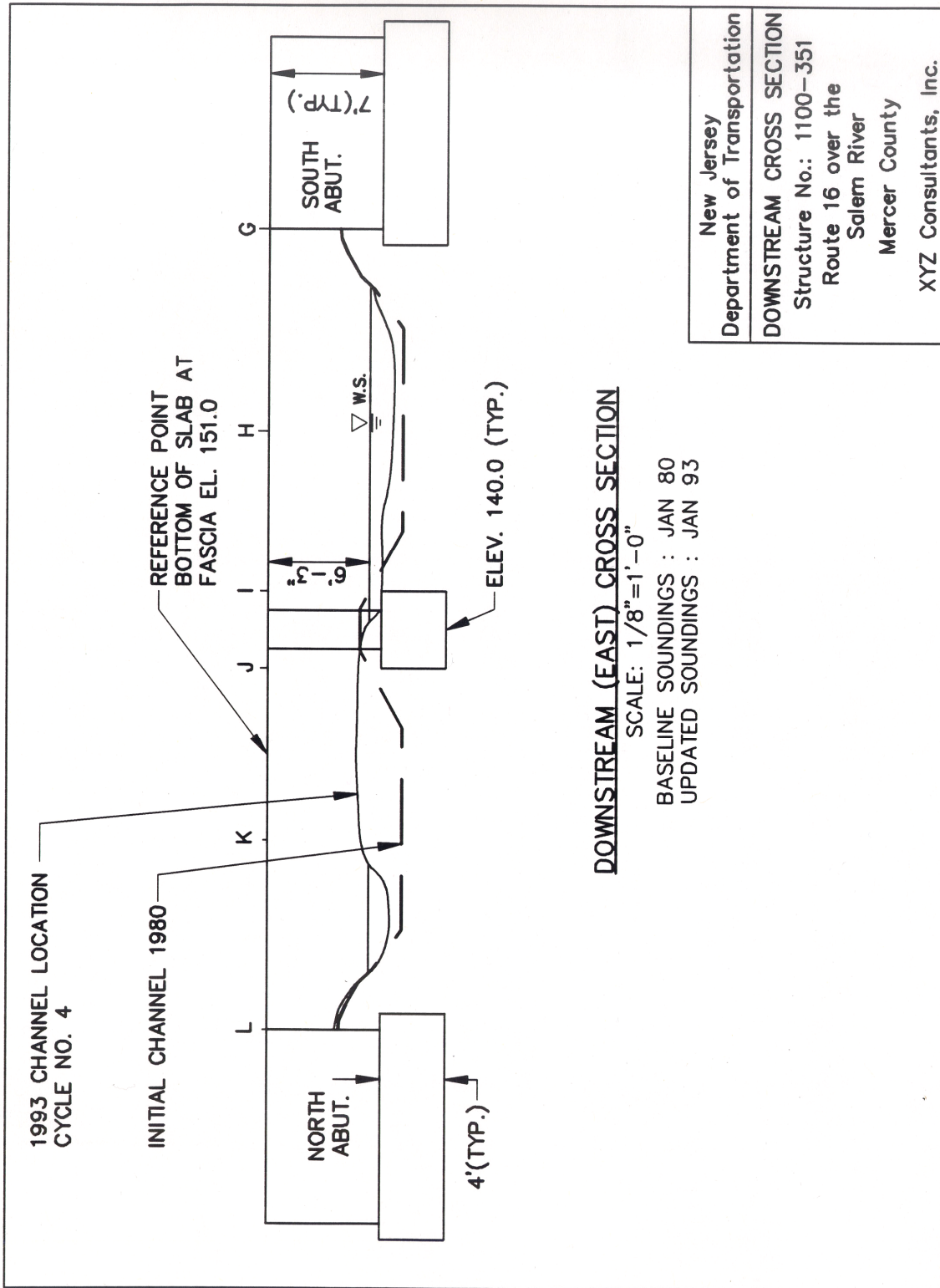

Figure 3-3

CHAPTER 3
PROCEDURES FOR TYPE 1 INSPECTION

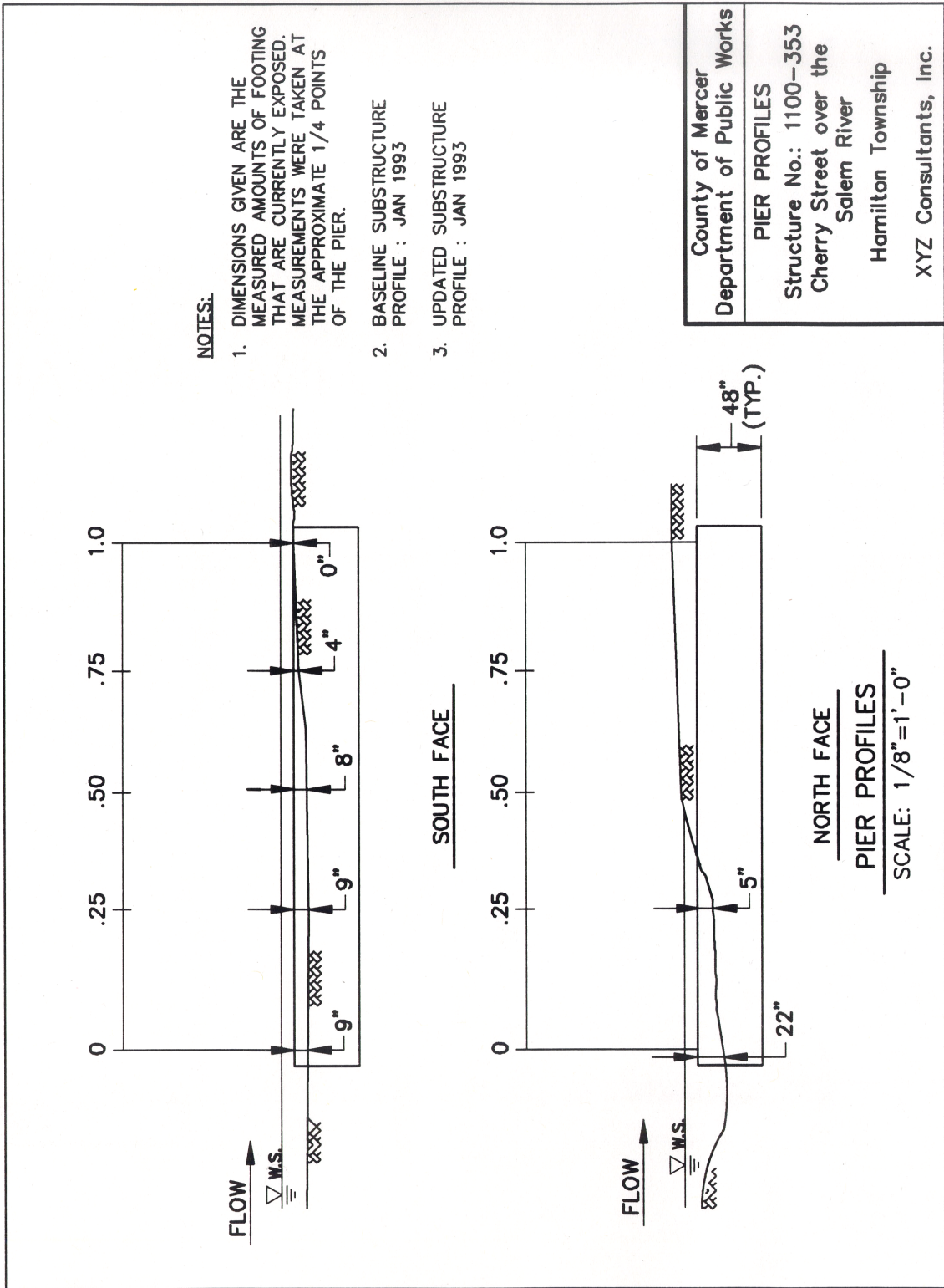

Figure 3-4

CHAPTER 3 PROCEDURES FOR TYPE 1 INSPECTION

3.2 INSPECTION FORMS

In addition to the channel plan and the cross section drawings, a Type-1 Underwater Inspection includes the completion of inspection forms which provide descriptive documentation of the channel and substructure elements. The two inspection forms, which are required for each waterway bridge, are:

1. **Waterway/Channel form** - which provides current information on the overall condition of the streambed morphology and embankments.
2. **Substructure Scour form** - which provides information on the current condition of the scour countermeasures and the embankment materials which are immediately adjacent to the substructure elements.

The following instructions have been developed to help promote uniformity in the completion of these two forms. The majority of the data required relates to the physical condition of various items found during the field survey. However, items related to changes since the previous inspection may best be completed in the office after a careful evaluation of all of the data collected and after the channel cross sections have been plotted.

3.2.1 Waterway/Channel Form

The information on this form focuses on the physical conditions of the waterway and its channel. It is to be completed for each waterway bridge, even if the channel is dry at the time of the inspection. In special cases, where more than one channel is crossed by the bridge, a separate form should be completed for each waterway channel location. The main objectives to be accomplished are:

- to accurately record the present condition of the waterway/channel.
- to identify conditions that are indicative of potential problems with scour and stream stability.

The following provides clarification on the specific items that should be addressed during the completion of this form.

Flow Conditions

Direction:

The general compass direction of the flow (e.g., north to south) should be noted. It should, however, be consistent with the orientation given for the bridge substructure elements. If the waterway is subject to tidal flows, that should also be noted.

CHAPTER 3
PROCEDURES FOR TYPE 1 INSPECTION

Magnitude: A general statement should be noted on the relationship between the volume of water observed flowing in the upstream channel during the course of the inspection, and the size of the bridge opening. Any comparisons with prior inspections would also be beneficial. (e.g. upstream flow channel approximately 20' wider than bridge opening under typical flow conditions).

Velocity: A general statement on the rate of flow observed during the course of the inspection should be noted. Actual measured flow rates are not required. (e.g. low or stagnant to high or rapid flows).

Embankments

Upstream/Downstream: Comment on the natural vegetation and stability of the embankment material on both sides of the bridge opening. Particular attention should be paid to bank sloughing, undermining and evidence of lateral movement or high velocity flows.

Channel Countermeasures: Comment on the presence and physical condition of any stream or bank stabilization measures that have been observed. Examples of bank stabilization methods include riprap, paving and gabions. Stream stabilization methods include guide banks, spur dikes and jetties.

Channel Movements & Changes

Horizontal Location: Comment on the horizontal location of the channel relative to the bridge opening. This should also include comments on any movement of the channel on either side of the bridge opening including locations of bends, meanders and point bars relative to the bridge opening. The potential changes or movements should be determined based on locations as noted from observations in previous inspection reports.

Cross Section: The relative location of the low point in the channel (thalweg) to the bridge opening should be noted. In addition, aggradation and degradation present at both the bridge and on either side of the opening should be documented.

CHAPTER 3
PROCEDURES FOR TYPE 1 INSPECTION

Alignment: The relative angle between the substructure elements and the main portion of the channel should be noted. Particular attention should be paid to elements which are misaligned.

Changes Since Previous Inspection: Any changes observed, since the previous inspection, to the cross section of the streambed or its horizontal location should be noted. This should include lateral movement of the channel, scour holes and aggradation or degradation of the channel.

**CHAPTER 3
PROCEDURES FOR TYPE 1 INSPECTION**

Structure No.: XXXX-XXX Route: XXXX Cycle No.: XX
 Name: XXXXX over XXXXX Creek Insp. Date: MM/DD/YYYY

UNDERWATER DIVING INSPECTION

WATERWAY/CHANNEL

SI&A Item No. 61: _____
 SI&A Item No. 71: _____
 SI&A Item No. 113: _____

RATING	COMPONENT	REMARKS
FLOW CONDITIONS		
	Direction	
	Magnitude	
	Velocity	
EMBANKMENTS		
	Upstream	
	Downstream	
	Channel Countermeasures	
CHANNEL MOVEMENT AND CHANGES		
	Horizontal Location	
	Cross Section	
	Alignment	
	Changes Since Previous Inspection	
	Navigation Clearances	
	Waterway Opening	
	Other	

Repair Quantities: _____

CHAPTER 3
PROCEDURES FOR TYPE 1 INSPECTION

3.2.2. Substructure Scour Form

The information on this inspection form focuses on the physical conditions of the streambed at each of the substructure elements which are potentially susceptible to scour. The information should be gathered even in cases where the streambed may be dry at the time of the inspection. The main objective of the form is to provide documentation of local scour problems that could effect the structural stability of the piers and/or abutments.

Space on the form is provided for two substructure units and the information should typically be input for each pier or abutment. A Substructure inspection form should also be completed for each pier or abutment to document the physical conditions and defects present.

The following provides clarification on the specific items that should be addressed during the completion of this form.

Countermeasures

Description: The existing countermeasures which are in place at the substructure element should be briefly described. If riprap is present, the approximate dimension of the stone size should also be noted. Countermeasures away from the bridge would not be included here, but should be noted on the Waterway/Channel form. If none are present, that should also be noted.

Condition: The physical condition of the existing countermeasures should be documented. For riprap, undermining and displacement should be noted.

Probing/Scour

Findings: **Any exposure of footings, pilings or other types of foundations is very important and should be documented.** In addition, based upon a probing of the materials around the substructure elements, any loose sediment, scour holes or organic debris should be noted. If none are found, a statement to that effect should be included.

Changes Since Previous Any changes observed, since the previous inspection,

CHAPTER 3
PROCEDURES FOR TYPE 1 INSPECTION

Inspection: to the physical conditions of the materials adjacent to the substructure element or its countermeasures should be noted.

Debris: Any debris found at or on the substructure element should be described. When materials are found, the nature and location of the debris and a general statement regarding the quantity should be included.

**CHAPTER 3
PROCEDURES FOR TYPE 1 INSPECTION**

Structure No.: XXXX-XXX Route: XXXX Cycle No.: XX
 Name: XXXXX over XXXXX Creek Insp. Date: MM/DD/YYYY

UNDERWATER DIVING INSPECTION

SUBSTRUCTURE/SCOUR

SI&A Item 60 Condition Rating: _____

PIER/ABUTMENT _____

RATING	COMPONENT	REMARKS
COUNTERMEASURES		

	Description	
	Condition	

PROBING/SCOUR

	Findings	
	Changes Since Prior Inspection	
	Debris	

Repair Quantities: _____

PIER/ABUTMENT _____

RATING	COMPONENT	REMARKS
COUNTERMEASURES		

	Description	
	Condition	

PROBING/SCOUR

	Findings	
	Changes Since Prior Inspection	
	Debris	

Repair Quantities: _____

CHAPTER 4

PROCEDURES FOR DIVING (TYPE 2 OR 3) INSPECTIONS

As detailed in Chapters 1 and 2 of this Manual, the evaluation and documentation of the underwater elements of a bridge are critical aspects in identifying potential problems related to its structural integrity. For most bridges in the state, a Type-1 Underwater Inspection will be sufficient and the required information can be adequately obtained without a diver by wading or probing. For other bridges, based upon the criteria given in Chapter 2, a diver is required due to the depth, current or visibility of the water. For these bridges, a Type-2 or possibly a Type-3 Underwater Inspection will be performed. The Department requires a Type-2 or Type-3 Underwater Inspection in alternate cycles of the biennial NBIS bridge inspections, unless a more frequent interval is warranted.

This Chapter will provide information on the scope and format of the documentation for underwater diving inspections. Unless specifically defined, this information will be applicable to a Type-2 or a Type-3 Inspection. Should a Type-4 Inspection be required, the specific scope and format of the documentation will be defined at the time of authorization based upon the project requirements.

4.1 STANDARD SCOPE OF WORK

The scope of work for a Type-2 or Type-3 Underwater Diving inspection for a bridge is comprised of the following tasks:

- Task 1 - Office Review
- Task 2 - Field Inspection
- Task 3 - Report Preparation

The standard scope for each of these three tasks follows:

Task 1 - Office Review

An office review, as part of a diving inspection, includes a review of the bridge plans and prior underwater inspection surveys performed for the elements of the structure that are to be inspected. Typically this effort is to familiarize both the diver and Team Leader (in cases where they are not the same person) with the substructure configurations and the previously observed defects.

Soundings or channel cross sections, which are typically contained in the previous inspection survey report, also provide the information necessary to check the channel for scour activity and the condition of any scour countermeasures. In addition, familiarization of the dive team with these items will make any communication between the diver and the Team Leader easier during the actual diving operation.

CHAPTER 4
PROCEDURES FOR DIVING (TYPE 2 OR 3) INSPECTIONS

Task 2 - Field Inspection

The scope of the field work for a diving inspection will be dependent on the nature and the type of structures involved. However, the following items are generally included, and a brief description of each is given below:

- A. Cleaning
- B. Inspection of Piers and Abutments
- C. Inspection of Piles
- D. Inspection of Fenders, Dolphins and Bulkheads
- E. Inspection for Scour Related Defects

A. Cleaning

The cleaning of marine growth from a portion of the substructure elements is a required part of a Type-2 or Type-3 Underwater Diving Inspection. The amount of growth will be dependent on the waterway environment. In fresh water, growth will generally be light and can often be removed by rubbing with a gloved hand. In salt water, however, the build-up can be more extensive and hand scrapers or power tools may be required.

Cleaning is often a time consuming and expensive proposition and therefore it should be restricted to critical areas of the structure. Selection of areas to be cleaned, however, should be made to minimize the potential for damage to the structure.

General guidelines for the areas of an element that should be cleaned are given in the FHWA Manual titled Underwater Inspection of Bridges and include the following:

1. For pile type structures, a 10 inch high band should be cleaned at designated locations generally near the low waterline, near the mudline and midway between these two points. The amount of the pile to be cleaned is dependent on the shape and the following rules should generally be followed:

<u>Shape</u>	<u>Area</u>
Rectangular	At least 3 sides
Octagon	At least six sides
Circular	Three-fourths of perimeter
H-pile	Outside faces of flanges & one side of web

CHAPTER 4

PROCEDURES FOR DIVING (TYPE 2 OR 3) INSPECTIONS

2. On large, solid-faced elements, such as piers and abutments, a one foot square area should be cleaned at three levels on each face of the element. The designated locations will generally be the same as for pile type structures.

The typical limits for the amount of cleaning required for a Type-2 Inspection will be on approximately 10% of the underwater substructure elements or equal to the amount of an NBIS Level II inspection. For a Type-3 Underwater Inspection, this amount will be greater.

When the diving work is to be subcontracted to an organization not responsible for the remainder of the inspection survey, the approximate limits and general locations of the areas of the elements to be cleaned should be clearly defined in the scope of work. Additional information on this and other aspects of the cost proposal, including its format, are contained in Chapter 6.

When selecting the elements or the areas to be cleaned as part of the inspection, the approach should be to choose areas which are:

- structurally critical
- subject to frequent deterioration for the specific configuration
- randomly selected but indicative of the substructure's overall condition

After the diving operation has been completed, the location and limits of the areas that were actually cleaned, and the equipment used for the cleaning during the diving inspection, should be documented in the appropriate section of the report. During subsequent inspections, unless specific defects are being reviewed, the location of the areas to be cleaned should be varied to obtain a representative sample of the physical condition of the bridge's underwater elements.

B. Inspection of Piers and Abutments

Piers and abutments will comprise the majority of the elements that will require an underwater inspection. The inspection consists of a close visual survey of the portion of these elements below the waterline. This inspection will also consist of a similar survey of the exposed portions of their footings. The inspection will provide an assessment of the existing physical conditions and documentation, including measurements, of any observed defects. The sketches and written documentation requirements are detailed in Section 4.3 of this Chapter.

CHAPTER 4

PROCEDURES FOR DIVING (TYPE 2 OR 3) INSPECTIONS

A full description of the types of defects typically observed in abutments and piers can be found in the previously referenced FHWA Manuals titled Underwater Inspection of Bridges and Bridge Inspector's Reference Manual 2002. In general, however, the underwater inspection should include the following for each of these material types:

- Concrete: Locate and provide the approximate depth and size of spalls, cracks, scaled areas or other voids, and the location and amount of section loss for any exposed reinforcing bars.
- Masonry: Locate and provide dimensions of the size of the voids from missing stones and the size and location of cracks, and describe the condition of the mortar pointing.
- Timber: Locate and provide dimensions, including the extent, of the areas which have evidence of decay and/or large checks and splits.

In addition, any collision or ice damage, debris or any other significant defects should be documented.

C. Inspection of Piles

Pile bents are often used as structural supports for bridges at piers and abutments. These bents typically consist of a combination of timber, concrete or steel piles, often with bracing for lateral support, and in most cases a pile cap for load distribution. As with the piers and abutments, the inspection consists of a close visual survey of the physical condition of the underwater portion of these elements and documentation of the findings. When recording defects at pile bents, unless otherwise noted, the standard numbering convention will be:

- bents from south to north or west to east
- piles from west to east or south to north
- faces in a counterclockwise direction

The inspection should include the following:

- Concrete Piles: Locate and provide the approximate depth, width and height of spalls and the location and amount of section loss for any exposed reinforcing bars or cables. For cracks, measure their size, length and location. If a crack is spalling on each edge, record the actual crack size, which is deeper than the spalled

CHAPTER 4

PROCEDURES FOR DIVING (TYPE 2 OR 3) INSPECTIONS

surface. The crack length should be measured from the waterline (at the time of the inspection) to the underwater end of the crack. If the crack extends above the waterline it should be documented, unless it was recorded during a previous inspection.

Steel
Piles:

Locate and provide the dimensions of areas of corrosion and section loss. Particular attention should be paid to vulnerable areas, such as at the waterline and mudline, and at the underwater connection between the steel pile and the concrete jacket. The following classifications should be used to document the degrees of rust:

Light Loose rust formation which stains steel or begins to show through paint by pitting surface.

Moderate Rust formation where the surface is beginning to scale or flake. These areas are more discernible, but no appreciable section loss is present (1/16" or less surface pitting).

Severe Heavy rust scale or heavy pitting of metal surface (1/8" or larger surface pitting). For piles with severe rust, measurements of section loss should be made in the areas of heaviest corrosion.

Timber
Piles:

Locate and provide dimensions, including the extent, of the areas which have section loss or evidence of decay (particularly bacteria, fungus and marine infestation). In addition, document the location of large checks and splits or other areas of lost section due to abrasion or collision damage. Particular attention should be paid to areas which are protected by concrete or fiberglass jackets or other protective forms. Where present the condition of the protective jacket, its connections and any cross bracing or connection bolts should also be documented.

CHAPTER 4

PROCEDURES FOR DIVING (TYPE 2 OR 3) INSPECTIONS

D. Inspection of Fenders, Dolphins and Bulkheads

Fenders, dolphins and bulkheads are typically provided at bridges for protective purposes. In most cases, they are of timber construction, although other materials may be present. The inspection consists of a close visual survey of the physical condition of the underwater portion of these elements and the documentation of the findings. The inspection of the materials comprising these items should follow the same documentation requirements as given above for the abutments, piers and piles.

E. Inspection for Scour Related Defects

Scour is the excavation and removal of material from the bed and banks of streams as a result of the erosive action of running water. This removal of material can often have a significant effect on the structural stability of the substructure supports for a bridge. A careful evaluation of the channel conditions is required since, with the exception of long term changes to the stream bed, the effects of scour are cyclical and the holes formed are often filled by the end of the storm or flood event.

In evaluating the potential effects of scour at a bridge site, the inspection team should be aware of the potential vulnerability of the bridge to scour damage. The Department has undertaken a scour evaluation program, which includes the majority of the waterway bridges in the state. The results of the program are now essentially complete and most of the bridges have now been assessed for their Scour Critical status. A Scour Critical bridge has a calculated potential scour depth that is below the spread footings on substructure units founded on soil or the calculated scour depth would make foundations founded on piles unstable due to the amount of exposure. Since there is a possibility that bridges with this condition could become unstable or even collapse due to scour, the underwater inspection of these bridges is very important. It is of particular importance that existing scour conditions on Scour Critical bridges be identified and repaired at the earliest possible time. This is due to the fact that the scour failure of Scour Critical bridges could be based on long term scour effects in addition to 'single storm event' type failures. In order to identify scour damage on these bridges as early as possible, the normal underwater inspection cycle for Scour Critical bridges is 24 rather than the normal 48 months. The repair of existing scour on a Scour Critical bridges is, at a minimum, a Priority 1 repair.

CHAPTER 4

PROCEDURES FOR DIVING (TYPE 2 OR 3) INSPECTIONS

A Scour Critical bridge that has had scour countermeasures installed can be removed from the Scour Critical category by revising the coding of SI&A Item 113. If the scour countermeasures were designed in accordance with the current HEC documents, then the coding for Item 113 should be changed to '8'. If the scour countermeasure has been design for a lesser or unknown standard, then the coding for Item 113 should be revised to '7'.

The underwater inspection requires a probing of the channel material adjacent to the substructure elements to determine if voids, loose sediment or organic debris is present. If found, measurements of the size and location of the scour holes or areas of loose sediment should be given. If undermining of the footing exists, the height between the bottom of the footing and the mudline and the depth dimension from the front edge of the footing to the point under the footing where bearing is established are also required.

To protect bridge elements from scour, countermeasures such as riprap and sheet piles are often used. Where these items are present (at an underwater element being inspected), an evaluation of their current physical condition is required.

The Substructure Scour form as required in Section 3.2.2 (Pages 27-29) of this Manual should be used to document the physical conditions found during the diving inspection for these items. If sketches are required to document exposed footings, scour holes or undermining, the Substructure Profile given in Section 3.1.4 (Pages 18 and 22) is required.

In some cases, the consultant responsible for the diving inspection may also be made responsible for gathering the channel sounding information or possibly preparing the channel cross sections at the bridge. If any of these items of work are to be performed by the diving subconsultant, the exact scope and responsibilities should be specifically defined. The format and requirements of these items are given in Section 3.1 (pages 13-22) of this Manual.

The completion of the Waterway/Channel form will be the responsibility of the consultant responsible for the routine in-depth inspection of the bridge, unless specifically defined otherwise.

CHAPTER 4

PROCEDURES FOR DIVING (TYPE 2 OR 3) INSPECTIONS

Task 3 - Report Preparation

An evaluation survey report will be prepared for each bridge to document the findings of the underwater inspection. The report for a Type-2 or Type-3 Underwater Inspection will consist of the following items:

1. Report Cover Sheet
2. Letter of Transmittal
3. Table of Contents
4. Summary
5. Conclusions and Recommendations
6. Appendix 1 - Drawings and Photographs
7. Standard Data Forms

Section 4.3 (pages 39-55) of this Manual provides the specific format and requirements for each of these items and a sample is provided in Appendix B.

4.2 QUALIFICATIONS OF DIVE TEAM PERSONNEL

The technical qualifications required of the individual performing the underwater inspection are dependent on the complexity and severity of the structural conditions of the individual bridge site, as well as the waterway's environment and conditions. The following have been established as minimum technical qualifications for those performing or responsible for an underwater inspection. The Occupational Safety and Health Administration (OSHA) requirements and operating procedures of 29 CFR Part 1910, Subpart T-Commercial Diving Operations shall be strictly adhered to without exception.

The minimum size of the dive team will be three (3) persons as follows:

Commercial Scuba Air Diving

1. Designated Person-in-charge (DPIC) - also known as the Diving Supervisor
2. Standby Diver
3. Diver (line tended)

Commercial Surface-Supplied Air Diving

1. DPIC
2. Diver
3. Tender

Per OSHA 1910.421(d) [Planning and Assessment], a standby diver shall be utilized whenever planning and assessment of diving activities indicates the potential of underwater debris, diver entanglement, suction, limited or no free access to the surface or

CHAPTER 4

PROCEDURES FOR DIVING (TYPE 2 OR 3) INSPECTIONS

where bottom conditions are unknown. In addition, as per OSHA 1910.424(c), a standby diver is always required when SCUBA diving.

The diver, standby diver and dive team training requirements are as follows:

A. The diver shall be commercially trained at an Association of Commercial Diving Educators (ACDE) accredited school complying with the requirements of ANSI/ACDE-01-1993, "Commercial Diver Training - Minimum Standard." A military diving school meeting the same standards is also acceptable training.

B. In lieu of A, a diver trained through either field experience or a combination of formal training and field experience. The OSHA diving standard (29-CFR 1910.410) specifies that all dive team members (i.e., divers and support employees involved in diving operations, including the DPIC) must have experience or training in the use of tools, equipment systems, techniques, diving operations and emergency procedures which pertain to their assigned tasks and diving modes (i.e., scuba diving on air, surface supplied diving on air or mixed gas diving). Additionally, dive team members who are exposed to hyperbaric conditions (e.g., diver) or control the exposure of others to hyperbaric conditions (e.g., DPIC or recompression chamber operator) must be trained in diving related physics and physiology. The level of training required by the standard depends upon the particular experience or function an employee fulfills on a dive team, the specific underwater operational tasks being performed and the diving mode to which the employee is assigned.

C. It is specifically noted that completion of the YMCA, PADI, NAUI or other essentially recreational diver training courses without significant additional training, do not meet the OSHA diving standard.

D. Records of all diver or dive team training shall be maintained by the diving company and be available for inspection.

E. All dive team members shall be trained in cardiopulmonary resuscitation and standard first aid (American Red Cross Standard).

4.2.1. Type-2 or Type-3 Diving Inspections

For the majority of bridges, where a Type-2 or Type-3 Underwater Inspection, as defined previously, will be required, the technical qualifications of those performing the inspection will be as follows:

(Revised: August 1997)

CHAPTER 4

PROCEDURES FOR DIVING (TYPE 2 OR 3) INSPECTIONS

1. The underwater inspection will be performed under the supervision of an individual (diver or consultant) who meets the Department's requirements for a Team Leader for the field inspection of bridges. These qualifications are as follows:

- A Professional Engineer (PE) in New Jersey or qualified for registration as a PE in New Jersey and has a minimum of 3 years experience in bridge inspection assignments in a responsible capacity;
- or**
- A Graduate engineer with a minimum of 5 years experience in bridge inspection assignments in a responsible capacity.

In addition, the Team Leader must have completed, within the last 5 years, a comprehensive training course which meets NBIS criteria (e.g., a course approved by the NJDOT based on the Bridge Inspector's Reference Manual).

If the individual actually performing the underwater inspection does not meet the above criteria, then an additional person (either diver or consultant) who does meet this criteria will be on-site for the entire duration of the underwater inspection activities. Where cleaning is required, the Team Leader does not need to be present during the actual cleaning activities.

2. The person performing the diving inspection activities (not cleaning), if different than the Team Leader, should have the following technical capabilities:

- A minimum of 3 years experience in underwater construction and/or diving inspection;
- Completion of a comprehensive bridge inspection training course which meets NBIS criteria (e.g., a course approved by the NJDOT based on the Bridge Inspector's Reference Manual).
- The ability to read and interpret engineering drawings.

Prior to undertaking any diving activities, the resumes of the above individuals must be submitted for approval to the Department of Transportation or the Consultant. The format for this submission is given in Chapter 6 of this Manual.

4.2.2. Type-4 Diving Inspections

In special cases, Type-4 (extensive NBIS Level II or NBIS Level III) diving inspections will be required. Typically, this will be in situations where a Type-2 or Type-3 diving inspection has already been performed. In these cases, since an evaluation is often required to determine the integrity, safety and load carrying capacity of individual elements or an

(Revised: August 2008)

CHAPTER 4
PROCEDURES FOR DIVING (TYPE 2 OR 3) INSPECTIONS

entire structure, the use of a diver meeting the qualifications of the Team Leader (as given in Item 1 of Section 4.2.1) is required. However, in emergency situations this requirement can be suspended with the approval of the Department's Project Manager.

4.2.3. Permit Required Confined Space

Where confined spaces are encountered as defined by 1910.146, all work will be performed in strict accordance with the Occupational Safety and Health Administration (OSHA) requirements and operating procedures of 29 CFR Part 1910.146, "Permit-required confined spaces."

Bridges or structures identified as a permit required confined space shall be entered as per OSHA 29 CFR 1910.146 standards and rules. The Consultant, Subconsultant or Contractor is to comply with the law and provide the Department with a copy of the entry procedures and a copy of an approved permit entry form to be used. The diver or designated entrant is to monitor the air in the confined space (culvert, pipe, etc.) and note the monitor readings upon entry and exit and each fifteen (15) minute interval while in the confined space. Each entrant shall have an approved escape capsule and/or approved independent air supply suitable and adequate for use in and for exiting the confined space.

Upon completion of the inspection or work, the diver/entrant shall apprise the Department or Consultant, if applicable, of any hazardous conditions encountered. The air monitor readings shall be noted on the entry permit, a copy of which shall be included with the report. The consultant/contractor is to supply all confined space entry equipment.

The consultant/contractor must have completed a training course on the OSHA 29 CFR 1910.146 standard and submit to the Department or Consultant a copy of the certification of training upon request.

Monitoring equipment shall be successfully calibrated prior to beginning work and shall be recalibrated as recommended by the manufacturer and/or when required.

A completed copy of the confined space entry permit (CSEP), when required, will be submitted for each structure with the inspection report.

Sample Bridge Data Sheet

Structure No.:	0605-150
Structure Name:	Route 49 over Mill Creek-Jackson Run
County/Township:	Cumberland County, Bridgeton City
Type:	Twin Barrel Reinforced Concrete Box Culvert
Underwater Inspection Requirements:	Superstructure, Substructure, Soundings
Approx. Water Depth:	5'
Structure Length:	28'
Structure Width:	58'
Hazard Analysis/Assessment:	Permit-required confined space. Possibility of industrial pollutants in the water and sediment. Hazardous gasses have been previously noted. Debris reported.

CHAPTER 4

PROCEDURES FOR DIVING (TYPE 2 OR 3) INSPECTIONS

4.3 DIVING REPORT FORMAT

As stated in Task 3 of Section 4.1 an evaluation survey report is required for each bridge to document the findings of the underwater inspection. The report for a Type-2 or Type-3 Underwater Inspection will consist of the following items:

1. Report Cover Sheet
2. Letter of Transmittal
3. Table of Contents
4. Summary
5. Conclusions and Recommendations
6. Appendix 1 - Drawings and Photographs
7. Standard Data Forms

The following is a description of the format and information that will be provided in each of these items. For additional information a completed sample report is provided in the Appendix.

1. Report Cover Sheet

The report's cover sheet shall include the structure number, structure name, route number, municipality, county and the month and year when the underwater inspection was performed. The name of the company that performed the diving should also be included, as well as the company responsible for the supervision (i.e. Team Leader), if different than the diver. The report should be bound using a standard 3-punch hole type binding.

2. Letter of Transmittal

The letter of transmittal shall be addressed as follows when the underwater inspection is being performed directly for the Department of Transportation:

Manager
Structural Evaluation
1035 Parkway Avenue
PO Box 600
Trenton, New Jersey 08605
Attn: _____, Project Engineer

Re: Bridge Underwater Inspection
of Structure No. _____
(bridge name and route number)

CHAPTER 4
PROCEDURES FOR DIVING (TYPE 2 OR 3) INSPECTIONS

The letter should include the date of the Agreement with the New Jersey Department of Transportation and any disclaimer and/or restrictions on the information contained in the report and its use. In addition, the letter should include a statement specifically indicating what measures were taken to assure the quality of the project.

In cases when the underwater inspection is being performed as a subcontract to another engineering firm which is responsible for the inspection of the bridge, the letter should be addressed to that consultant's Project Manager. The format and contents, however, should be the same.

The letter should be signed by a person who meets one of the following:

1. The qualified team leader of the diving contractor.
2. A principal of the diving firm.

3. Table of Contents

The table shall be in the format indicated below and should provide the page number of the report on which each item starts.

TABLE OF CONTENTS

	<u>Page</u>
Summary	
Conclusions and Recommendations	
Appendix 1 - Drawings and Photographs	
Appendix 2 - Standard Data Forms and Field Notes	

Following the table of contents, all pages in the report should be numbered and all of the numbers should be typed.

4. Summary

A summary of the underwater inspection findings shall be included as per the format provided in Exhibit 1 given at the end of this section. The information provided in the summary shall include both general data as well as a brief description of the findings of the underwater inspection. The format of the section shall include a paragraph for each of the major components or items included in the underwater inspection survey (Abutments, Piers, Probing/Scour,

CHAPTER 4

PROCEDURES FOR DIVING (TYPE 2 OR 3) INSPECTIONS

Countermeasures and Fenders/Bulkheads). If piers or fenders and bulkheads are not present, this item can be eliminated. If no scour countermeasures are present, however, a statement should still be included under the general remarks section indicating that none are present.

The general remarks section should begin with a paragraph stating the overall condition of the components, based on the underwater inspection. This should be followed by a list of the significant defects, deterioration or distress which lead to the condition rating.

The FHWA's codes and descriptions for general condition ratings, as given in their "Recording and Coding Guide", should be followed in describing the overall condition of the components. Photographs should be referenced to the appropriate condition or defect which they illustrate in the remarks.

The majority of the items included are self-explanatory; however, further clarifications are provided below. For additional information, refer to Exhibit 1 and the completed sample report in the Appendix.

Evaluation by: The name of the company which performed the actual diving operation.

Supervision by: The name of the consultant which was responsible for the Team Leader (if different than the name of the diving company).

Type of Underwater Inspection: A listing of which type (2 or 3) of underwater inspection was performed according to the classifications given in Chapter 2 of this Manual. If there was more than one type of Inspection, the specific areas receiving each should be listed.

Underwater Inspection Equipment Used: A listing of the cleaning equipment as well as the diver's equipment (e.g., scuba, surface supplied air, etc.). If a boat was required it should also be listed here together with any other specialized cleaning or measuring equipment.

Substructure Elements Cleaned: The physical location of the areas and designation of the substructure element (e.g. north abutment, pier 1, etc.) which were cleaned as part of this inspection should be listed. If none, that should also be indicated.

CHAPTER 4
PROCEDURES FOR DIVING (TYPE 2 OR 3) INSPECTIONS

Water Flow Velocity:	The approximate velocity of the waterway, based upon visual observations made during the inspection, should be listed. If tidal flow exists, it should be noted and the maximum observed rate given. Actual measured flow rates are not required (e.g. low or stagnant to high or rapid flows).
Soil Type:	The predominate type of soil material present in the channel based upon visual observations should be listed (i.e. silty clay, fine/course sand, organic till, etc.).
Diving Mode:	Indicate the diving mode utilized to conduct the underwater inspection such as Commercial Surface Supplied Air, Commercial Air Scuba or Commercial Surface Supplied Mixed Gas.
Dive Team Members:	Indicate the number of members in the dive team that conducted the underwater inspection.
Diving Hazard Analysis/ Assessment:	Indicate the presence of any hazards or special assessment necessary to be considered during the underwater inspection from the following list: CS-Confined Space PD-Potential Underwater Debris LA-Limited or No Free Access to the Surface BU-Bottom Conditions Unknown DE-Possible Diver Entanglement SH-Suction Hazard EF-Excessive Flows or Currents NH-No Assessed Hazards
Abutments/Piers:	If more than one type exists they should be grouped by material or configuration and described separately.
Countermeasures:	A description of the countermeasures currently in-place at the substructure elements but not related to the embankment stability, unless they also act to protect the abutments and/or piers.
Probing/Scour	Any discovery of exposed footings, pilings or other types of foundation should be noted. In addition, any loose sediment, scour holes or organic debris should be noted. If none are found, a statement to that effect should be included.

CHAPTER 4
PROCEDURES FOR DIVING (TYPE 2 OR 3) INSPECTIONS

5. Conclusions and Recommendations

This section of the report shall contain the conclusions and recommendations that result from the underwater inspection. The format of this section shall be as per Exhibit 1 given at the end of this section. In addition, a completed sample is given in the Appendix. This section shall include the following:

- an overall statement on the physical conditions of the underwater substructure elements based upon the portions which were inspected
- a statement on scour at the bridge, based on observations made during the underwater inspection, related to the condition of countermeasures, exposed footings, scour holes, aggradation or degradation and lateral movement of the channel
- a brief description of significant changes to the underwater portion of the structure or channel bed since the previous inspection which could also include repairs made (if no changes are present, a statement to that effect should also be included)
- a list of specific recommendations for repairs including location, quantity and recommended method of repair, which should be listed in order of priority (Exhibit 2 at the end of this section provides a description of the various repair categories, including examples).
- a recommendation regarding the interval and inspection type for the next underwater inspection and any areas which may require additional in-depth inspection or cleaning

6. Appendix 1 - Drawings and Photographs

This section should include drawings made and photographs taken related to the underwater inspection of the bridge.

- Drawings

Drawings should be made to document the location and dimensions of the defects observed during the underwater inspection of the bridge. The scale for these drawings should be chosen such that they can be typically displayed on a letter sized page.

CHAPTER 4

PROCEDURES FOR DIVING (TYPE 2 OR 3) INSPECTIONS

Each substructure element should be illustrated on an individual page, although groupings can be made if the defects are minor and/or typical for several locations or if the scale is such that it does not affect the clarity of the presentation.

Figure 4-1 shows an example of the format for these drawings. Additional examples can be seen in the sample of the completed report given in the Appendix.

If drawings are necessary to document exposed footings, scour holes or undermining, they can be in this format or the similar format given for substructure profiles in Section 3 of this Manual.

If channel cross sections are included in the scope of work of the subcontract for the diving inspection, they should follow the format given in Section 3 and they should be included in this Section.

- Photographs

Any photographs taken during the underwater inspection should be mounted according to the standard format given in Exhibit 3 at the end of this Section.

CHAPTER 4
PROCEDURES FOR DIVING (TYPE 2 OR 3) INSPECTIONS

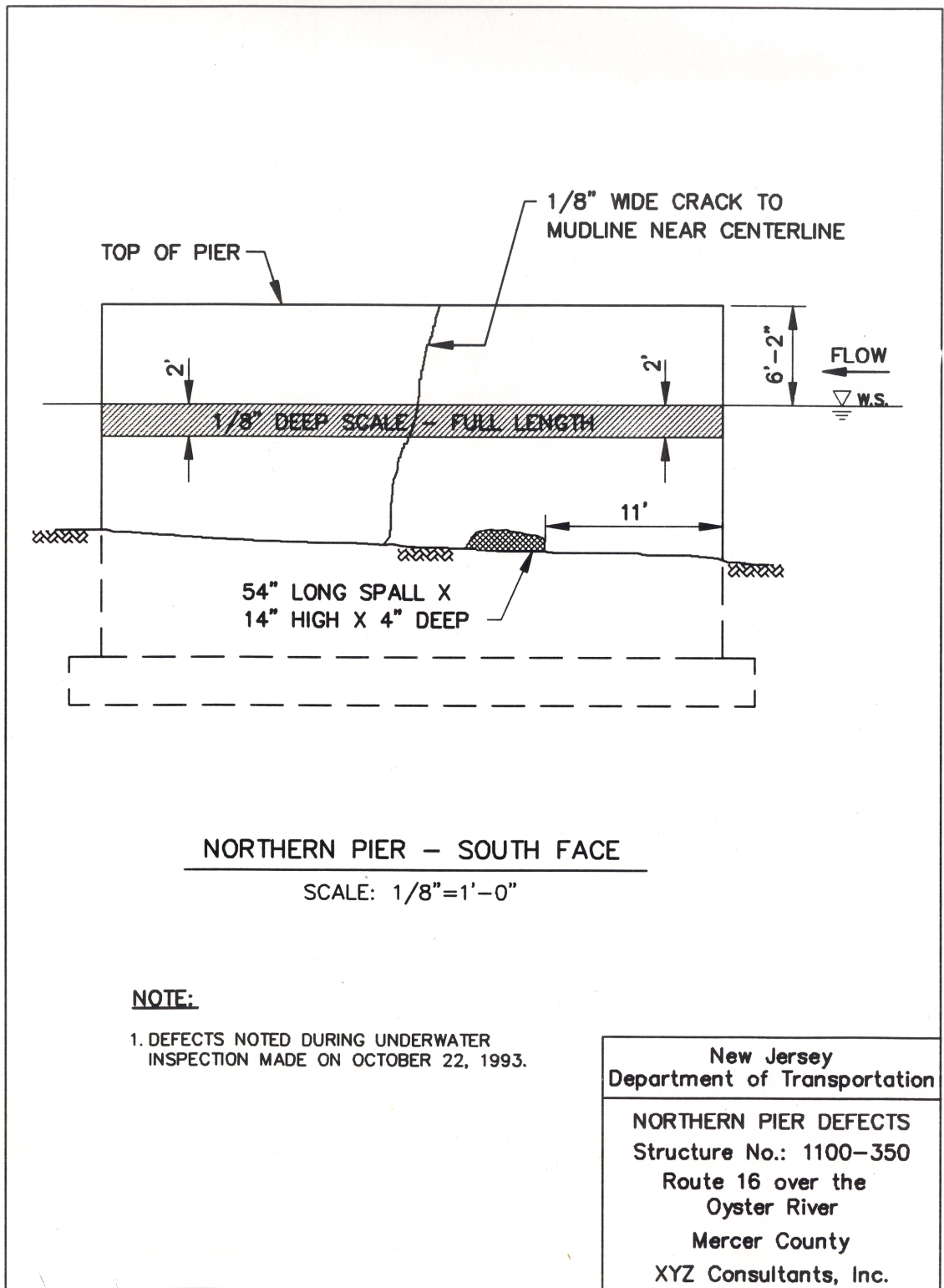

Figure 4-1

CHAPTER 4

PROCEDURES FOR DIVING (TYPE 2 OR 3) INSPECTIONS

Underwater photography is not required for Type-2 or Type-3 Underwater Inspections, unless specifically requested in the scope. Photographs, however, should be taken in both cases if a more in-depth inspection or an Emergency or Priority #1 or #2 repair is being recommended for a particular defect.

Photographs are required for a Type-4 Underwater Inspection. The number and location will be dependent upon the scope of the inspection.

In all cases, inspection photographs are not required when visibility is restricted and the photograph does not reasonably show the defect.

Photographs of the general configuration of the substructure elements or defects extending above the water surface are not required unless specifically requested in the scope. They can, however, be included if they help to clarify the defects observed.

When photographs are included a plan sketch is required to show the number, direction and location of each photograph.

7. Standard Data Forms

The completed standard data forms shall be included in this section of the evaluation report. The following forms are to be included:

- General Data
- Abutments
- Piers
- Substructure Scour
- Channel/Waterway (if specified in scope)

Blank copies of these forms are included at the end of this Section as Exhibit 4. For additional information see the completed sample report given in the Appendix.

**N.J.D.O.T. - STRUCTURAL EVALUATION
UNDERWATER BRIDGE EVALUATION SURVEY REPORT**

STRUCTURAL DATA:

Bridge No.:	XXXX-XXX	Year Built:	YYYY	Widened/ Rehab:	YYYY
Route No.:	XX	Length:	XX'	Width:	XX.X'
Mile Point:	XXX.XXX	Date of this Evaluation:	MM/DD/YYYY		
Name:	XXXXXXXXXX	By:	ABC		
		Supervision by:			
Structure Type:	XXXXXXXXXX	Date of Previous Evaluation:	MM/DD/YYYY		
		By:	XYZ		

OVERALL CONDITION: XXX

WORK DONE: XXXX

SUMMARY:

Number of Substructure Units in Water:	Abutments:	XX	Piers:	XX
Type of Underwater Inspection:	XX			
Underwater Inspection Equipment Used:	XXXXXX			
Substructure Elements Cleaned:	XXXXXX			
Water Flow Velocity:	XXXX	Soil Type:	XXXXXX	
Diving Mode:	XXXXXX	Dive Team Members:	XXXX	
Diving Hazard Analysis / Assessment:	XXXX			
Reference Information:	XXXXXX			

Structure No.: XXXX-XXX Route: XXXX Cycle No.: XX
 Name: XXXXX over XXXXX Creek Insp. Date: MM/DD/YYYY

COMPONENT / MATERIAL	GENERAL REMARKS
ABUTMENTS (Concrete)	<u>North Abutment:</u> XXXXX <u>Northwest wingwall:</u> XXXXX <u>Northeast wingwall:</u> XXXXX <u>South Abutment:</u> XXXXX <u>Southwest wingwall:</u> XXXXX <u>Southeast wingwall:</u> XXXXX
PIER (Solid Concrete Wall)	XXXXX
PROBING/SCOUR	XXXXX
COUNTERMEASURES	XXXXX
FENDERS/ BULKHEADS	XXXXX

CONCLUSIONS AND RECOMMENDATIONS

The overall condition of the underwater components of the substructure is (verbal condition rating) due to _____.

Based on the Bridge Scour Evaluation information on NJDOT web site, this bridge is not scour critical and Item 113 is coded as 8.

Based upon our probing of the streambed materials adjacent to the substructure and our review of the condition of the scour countermeasures and prior reports and plans, the bridge appears to have (no) potential scour problems. (If scour related problems are present they should be listed.)

Since the previous underwater inspection, (no or the following) significant changes have occurred:

(Significant changes to the various underwater components or channel bed should be listed. This should also include any work done or repairs made.)

Due to the _____ conditions observed in _____ during our underwater inspection, the following repairs should be made to retard further deterioration, preserve the structural integrity of the bridge, improve safety and extend its useful life:

(List recommendations for repairs with quantities only.)

In addition, we recommend a Type (indicate number) Underwater Inspection of the bridge on a (up to 4 year) interval. (If a Type-3 or Type-4 Underwater Inspection is recommended, a list of the specific elements and Type of inspection, as well as the interval, is required.)

PRIORITY REPAIR CATEGORIES

Repairs to bridges are categorized according to their significance in terms of the effect on the safety of the traveling public. The categories range from emergency, which require immediate attention, to low. Following are descriptions of each category and examples of the types of substructure or other scour related repairs:

Emergency (Highest)

This category includes major defects in the structure that, if not repaired immediately, may require closing the bridge or a portion thereof and could lead to a total collapse of the structure.

Included in this category are defects affecting the structural integrity of the bridge. In many instances it will be necessary to block-off the affected area or close the bridge entirely until the repairs are made. Also included would be defects, which in the judgment of the engineer, require immediate attention to eliminate significant safety hazards to the traveling public.

Examples of underwater or scour related repairs included in the Emergency (Highest) category are:

1. Substantial (more than 50%) undermining of the bearing area of a non-redundant element.
2. Deterioration or other conditions which cause a main load carrying member to become unstable.

If a defect requiring an Emergency category repair is discovered during the course of the underwater inspection, the consultant shall immediately inform their respective Department Managers (usually using a telephone in the field) regarding the situation. For County owned structures, the County Engineer shall also be notified in a similar manner. In addition, the suggested repairs and/or countermeasures together with their respective cost estimates shall be prepared and included in the Underwater Inspection Report.

Priority #1 (High)

This category includes major defects in the structure that, if not repaired immediately, may cause a significant load restriction and partial or total collapse of the structure.

Included in this category are defects affecting the stability of the structure. In many instances, it may be necessary to post load or speed limits or to partially block off the affected area to vehicular traffic until the repairs are made. Also included would be defects that, in the judgement of the engineer, need immediate attention to either maintain the level of service or ensure the safety of the traveling public.

Examples of underwater or scour related repairs included in the Priority #1 (High) category are:

1. Major local scour problem with undermining of footings not on piles or sound rock (rock not susceptible to erosion).
2. Substantial rotational movement, settlement causing distress in the abutment or pier.

If a Priority 1 repair is discovered during the course of the underwater inspection, the consultant shall immediately inform their respective Department Project Managers regarding the situation. For County owned structures, the County Engineer shall also be notified. In addition, the suggested repairs and/or countermeasures, together with their respective cost estimates, shall be prepared and included in the Underwater Inspection Report.

Priority #2 (Medium)

This category includes repairs of major imminent defects in the structure that, if not repaired in the near future (within \pm 3 months), may cause a load restriction or partial collapse of the structure. Also included will be any defects which would risk the safety of the traveling public in the near future. Judgement will be required to evaluate the overall situation to properly categorize the recommendation.

Examples of underwater or scour related defects included in the Priority #2 (Medium) category are:

1. Major local scour problems with footings on piles.
2. Significant scour of the material within the limits of a footing that is on overburden.

If a Priority 2 repair is discovered during the course of the underwater inspection, the Consultant shall highlight the situation to their respective Department Project Manager and the County Engineer, for County owned structures, by memorandum to file or letter. The procedure for repair and/or countermeasure recommendations and cost estimates will be the same as those indicated in the Priority 1 category.

Priority #3 (Low)

This category includes all other repairs not falling into the other two categories. Countermeasure recommendations and cost estimates are not required for this category.

Exhibit 3

Structure No.: XXXX-XXX Route: XXXX Cycle No.: XX
 Name: XXXXX over XXXXX Creek Insp. Date: MM/DD/YYYY

		Photo No: UW-01
Location:		
Description:		
		Photo No: UW-02
Location:		
Description:		

EXHIBIT 4

UNDERWATER DIVING INSPECTION FORMS

- **General Data**
- **Deck**
- **Superstructure**
- **Substructure Scour**
- **Abutments**
- **Piers**
- **Substructure Scour**

Structure No.: XXXX-XXX Route: XXXX Cycle No.: XX
Name: XXXXX over XXXXX Creek Insp. Date: MM/DD/YYYY

**NEW JERSEY DEPARTMENT OF TRANSPORTATION
STRUCTURAL EVALUATION
UNDERWATER DIVING INSPECTION
(FIELD NOTES)**

Name: XXXX
Diver: XXXX, XXXX (First name, Last name)
Company: ABC Consultant
Team leader: XXXX, XXXX (First name, Last name)
Company: XYZ Consultant
Temperature: XX° F Weather: Sunny
Equipment Used: XXX

RATINGS: *(Highlight the applicable RATINGS which coded under overall condition of Structure)*

- N Not applicable
- 9 Excellent Condition
- 8 Very Good Condition – no problems noted.
- 7 Good Condition – some minor problems.
- 6 Satisfactory Condition – some minor deterioration of structural elements.
- 5 Fair Condition – minor section loss of primary structural elements.
- 4 Poor Condition – advance section loss of primary structural elements.
- 3 Serious Condition – seriously deteriorated primary structural elements.
- 2 Critical Condition – facility should be closed until repairs are made.
- 1 Imminent Failure Condition – facility closed. Study of repairs is feasible.
- 0 Failed Condition – facility is closed and beyond repair.

GENERAL

Type of Bridge: XXXXXX
Type of Substructure: XXX
No. of Lanes: On XX Under Waterway
Number of substructure units in water: Abutments: XX Piers: XX
Overall condition of substructure: XXX

WATERWAY:

Type: XXX Velocity: XX
Streambed material: XXXX

*** Cycle number shall coincide with the Routine Bridge Evaluation Report.**

Structure No.: XXXX-XXX Route: XXXX Cycle No.: XX
 Name: XXXXXX over XXXXX Creek Insp. Date: MM/DD/YYYY

UNDERWATER DIVING INSPECTION

DECK

SI&A Item 58 Condition Rating: _____

SPAN # XXX

RATING	COMPONENT	REMARKS
	Wearing Surface / Top of Deck	
X	Underside of Deck (Concrete)	XXXXX
	Median	
	Curbs	
X	Sidewalks / Safetywalks (Concrete)	XXXXX
	Parapets/ Balustrades	
	Railings/ Fencing	
	Deck Joints/ Filler Material	
	Drains and Scuppers	
	Light Stands	
X	Utilities	XXXXX
	Others	

**Additional
Remarks:**

Note: Inspection of Underside of DECK , underside of SIDEWALK/SAFETEWALKS and UTILITIES (within superstructure) field notes are ONLY applicable when in the scope e.g. There is low freeboard.

Structure No.: XXXX-XXX Route: XXXX Cycle No.: XX
 Name: XXXXXX over XXXXX Creek Insp. Date: MM/DD/YYYY

UNDERWATER DIVING INSPECTION

SUPERSTRUCTURE

SI&A Item 59 Condition Rating: _____

SPAN # _____

RATING	COMPONENT	REMARKS
	Stringers / Girders/ Floorbeams/ Trusses/ P/S. Beams (Stringers numbered)	
	Diaphragms / Cross Frames	
	Bearings	
	Deflection and Vibration	
	Others	

**Additional
Remarks:**

FATIGUE DETAILS

Estimated percentage of Large trucks in ADT = X%

Category	Detail Description and Location
N/A	

Note: SUPERSTRUCTURE field notes are ONLY applicable when required in Scope.

Structure No.: XXXX-XXX Route: XXXX Cycle No.: XX
 Name: XXXXX over XXXXX Creek Insp. Date: MM/DD/YYYY

UNDERWATER DIVING INSPECTION

SUPERSTRUCTURE
(ARCH)

SI&A Item 59 Condition Rating: _____

SPAN # _____

RATING	COMPONENT	REMARKS
	Intrados of Arch (Soffit) Arch Ribs	
	Spandrel Columns/ Extrados	
	Spandrel Walls	
	Others	

**Additional
Remarks:**

***Note:** SUPERSTRUCTURE field notes are ONLY applicable when required in Scope.*

Structure No.: XXXX-XXX Route: XXXX Cycle No.: XX
 Name: XXXXX over XXXXX Creek Insp. Date: MM/DD/YYYY

UNDERWATER DIVING INSPECTION

SUPERSTRUCTURE
(RIGID FRAME)

SI&A Item 59 Condition Rating: _____

SPAN # _____

RATING	COMPONENT	REMARKS
	Intrados of Frame	
	Legs of Frame	
	Spandrel Walls	
	Others	

**Additional
Remarks:**

Note: SUPERSTRUCTURE field notes are ONLY applicable when required in Scope.

UNDERWATER DIVING INSPECTION

PAINT INSPECTION

*Environment: _____

Date of Last Painting: _____

- 1. Rural or Industrial, Mild exposure
 - 2. Industrial, Severe Exposure
 - 3A. Marine, Mild Exposure
 - 3B. Marine, Severe Exposure
- *Ref. NJDOT Design Manual Sec. 1.24.19

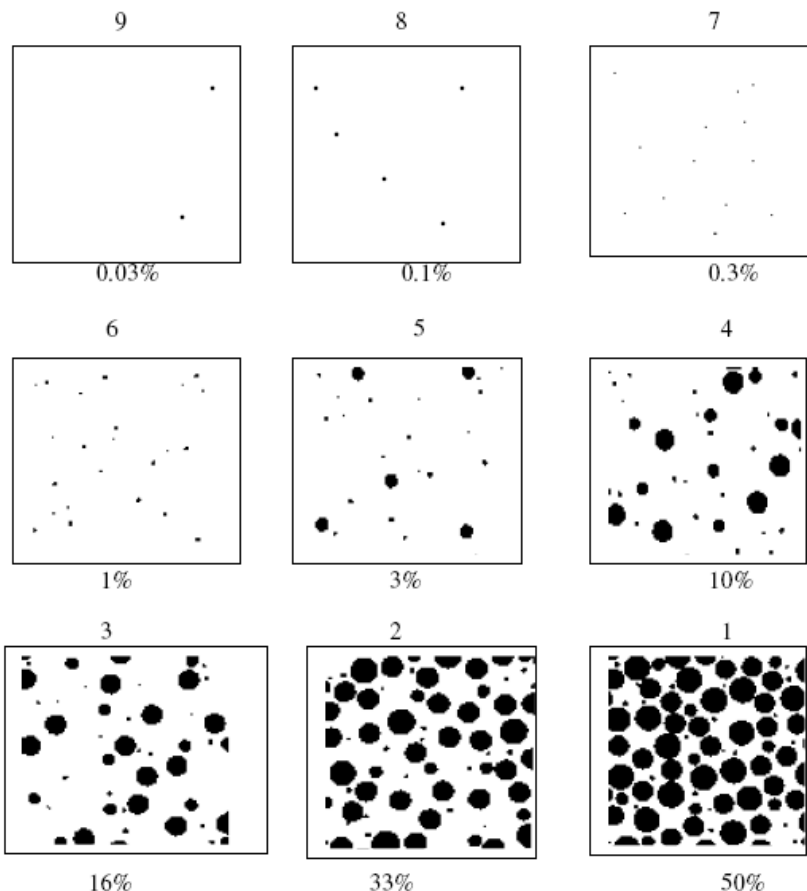

Note: Blistered Paint areas are counted as rust

10 = 0% Rust
0 = 100% Rust

Note: Use the closest rating to the actual field condition based on the average for the bridge. Indicate any areas of severe rusting in remarks.

FIG. 1 Examples of Area Percentages

INSPECTION RATINGS (0 THROUGH 10 OR N/A)

Fascia Beam: _____ Fascia Bottom Flange: _____ Beams Ends: _____
 Interior Beam: _____ Interior Bottom Flange: _____ Connections: _____
 Bracing: _____ Substructure: _____ Railings/Fence: _____
 Bearings: _____ Above Deck Superstructure _____

Remarks 1: _____
 Remarks 2: _____

Note: SUPERSTRUCTURE field notes are ONLY applicable when required in Scope.

UNDERWATER DIVING INSPECTION

TYPICAL FATIGUE DETAILS *(High light applicable detail)*

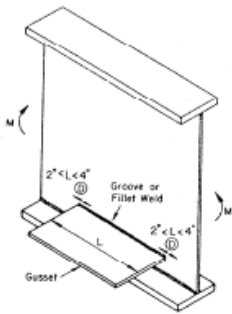

Short Wed Gusset Plate $L < 4$ in. Category D
Detail 1

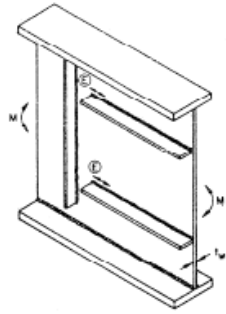

Termination of Longitudinal Stiffeners
 Category E **Detail 2**

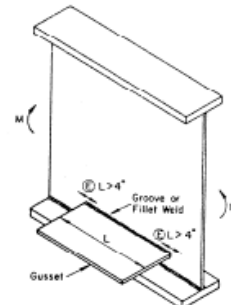

Web Gusset Plate Category E
Detail 3

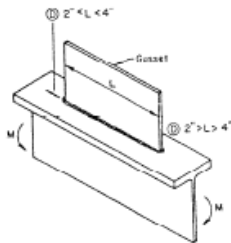

Short Flange Gusset Plate $L \leq 4$ in. Category D
Detail 4

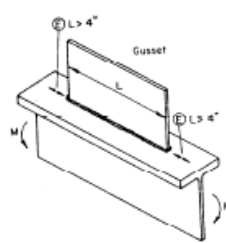

Flange Gusset Plate Category E
Detail 5

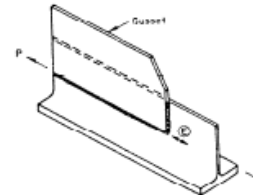

Gusset Welded to Bracing Member
 Category E **Detail 6**

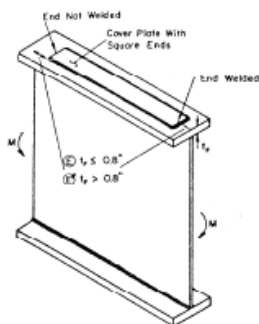

Square Ended Cover Plates Narrower than
 the Girder Flange Category E or E'
Detail 7

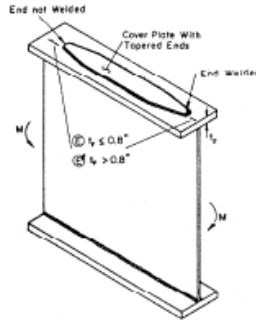

Cover Plates Narrower than the Girder Flange
 with Tapered Ends Category E or E'
Detail 8

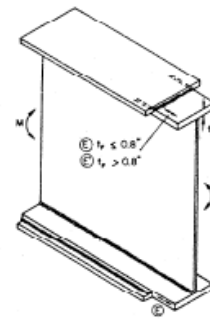

Cover Plates Wider than the Girder Flange
 with End Welds Category E or E'
Detail 9

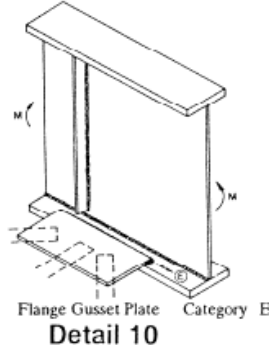

Flange Gusset Plate Category E
Detail 10

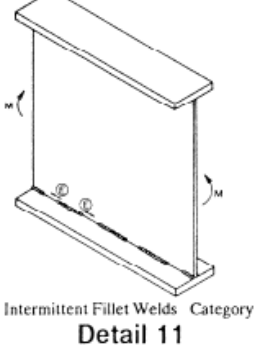

Intermittent Fillet Welds Category E
Detail 11

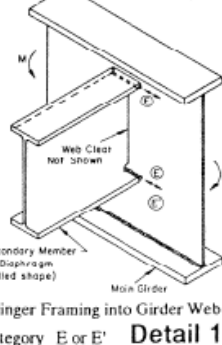

Stringer Framing into Girder Web
 Category E or E' **Detail 12**

Note: SUPERSTRUCTURE field notes are ONLY applicable when required in Scope.

Structure No.: XXXX-XXX Route: XXXX Cycle No.: XX
Name: XXXXX over XXXXX Creek Insp. Date: MM/DD/YYYY

UNDERWATER DIVING INSPECTION

TYPICAL FATIGUE DETAILS

13. Field Weld Repairs - Proper welding procedures may not have been used; testing of weld by non-destructive methods was usually not done, therefore, the possibility of large flaws exists. Check carefully on the main structural members (stringers, floorbeams, girders).
14. Tack Welds - Check carefully on riveted members constructed in 1940's and 1950's as these welds were sometimes used to hold the plates together during riveting.
15. Plug Welds - Check at bolted connections on welded structures. These welds may have been used to fill-in incorrectly drilled holes (see sketch).
16. Backing Bars - These welds are possibly not full penetration. Check carefully on box girders if accessible and at butt (groove) welds made in the field.
17. Details with 2 or 3 Intersecting Welds (Slot Welds) - Incomplete penetration of the second and third welds is possible.
18. Butt (Groove) Welds on Horizontal Web Stiffeners - NDT of the weld was not always required on the stiffener in the tension zone. If the weld is not good, this will be an "E" detail or worse which can exist in a high stress area (This would be the same as or worse than typical detail 3).
19. Detail Without Proper Welding Clearance - Poor welding can result if proper clearance for the welding rod is not maintained by the designer (such as a horizontal web stiffener placed too near the bottom flange of a girder; fillet weld at bottom of stiffener is difficult due to a lack of clearance for the welding rod).
20. Coped or Blocked Flanges - Check carefully when these details exist on main structural members (stringers and floorbeams). Coped flanges are a typical detail on movable spans.
21. Distortion (Bending) at Small Gaps - For typical details which exhibit damage due to this, see "Inspecting Steel Bridges for Fatigue Damage" (see sketches).

Note: SUPERSTRUCTURE field notes are ONLY applicable when required in Scope.

UNDERWATER DIVING INSPECTION

TYPICAL FATIGUE DETAILS *(High light applicable detail)*

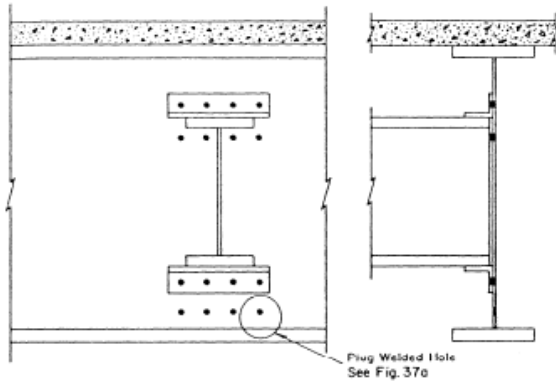

Schematic Showing Misplaced Holes Filled with Weld
Detail 15

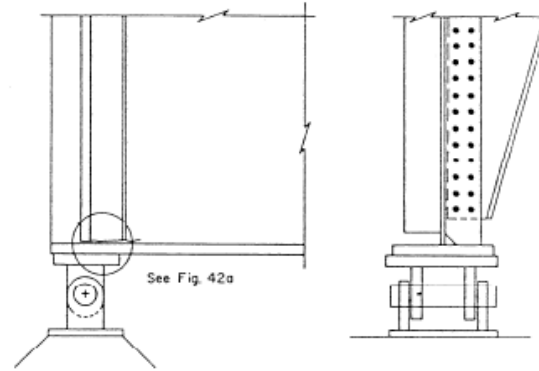

Schematic Showing Crack in Girder Web at
 Floor Beam Connection Plates at Supports
Detail 21A

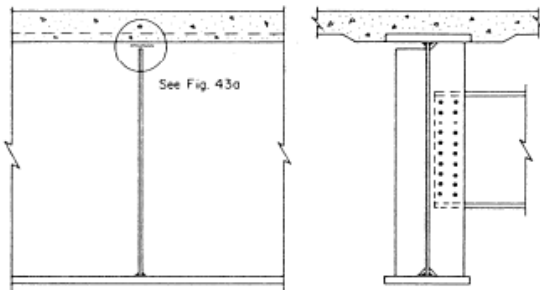

Schematic of Crack in Girder Web at Floor Beam
 Connection Plates in Negative Moment Region
Detail 21B

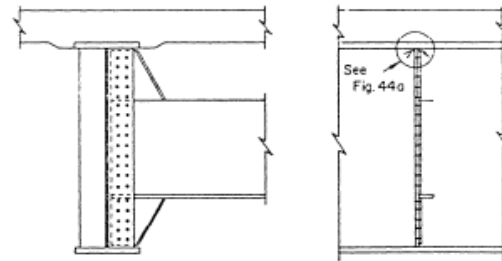

Schematic of Crack in Girder Web and Transverse Connection Plate
 Welds at Floor Beam in Negative Moment Region of Skewed Bridge
Detail 21C

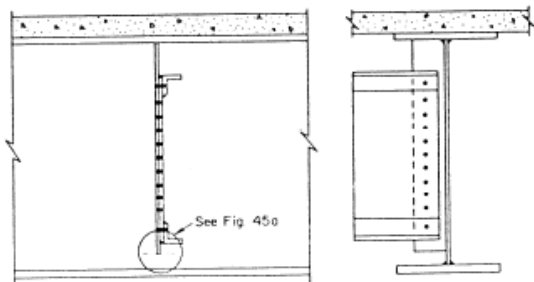

Schematic of Transverse Diaphragm Attached to Cut Short
 Welded Connection Plate Showing Web Cracking in Gap
Detail 21D

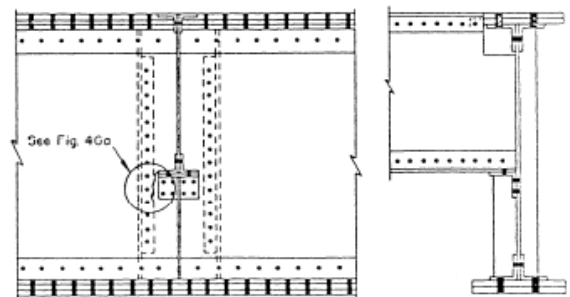

Schematic Showing Stringer Framing into Riveted Floor Beam With
 Crack Between Seat Angle Connection and Adjacent Web Stiffeners
Detail 21E

Note: *SUPERSTRUCTURE field notes are ONLY applicable when required in Scope.*

Structure No.: XXXX-XXX Route: XXXX Cycle No.: XX
 Name: XXXXX over XXXXX Creek Insp. Date: MM/DD/YYYY

UNDERWATER DIVING INSPECTION

SUBSTRUCTURE

SI&A Item 60 Condition Rating: _____

ABUTMENT _____

RATING	COMPONENT	REMARKS
	Breastwall (Concrete)	
	Backwall	
	Bridge Seat	
	Wingwalls/ Retaining Walls (Concrete)	
	Embankment / Slope Protection	
	Others / Footings / Waterway Probing	

**Additional
Remarks:**

Structure No.: XXXX-XXX Route: XXXX Cycle No.: XX
 Name: XXXXXX over XXXXX Creek Insp. Date: MM/DD/YYYY

UNDERWATER DIVING INSPECTION

SUBSTRUCTURE

SI&A Item 60 Condition Rating: _____

PIER _____

RATING	COMPONENT	REMARKS
	Columns/ Stem Crashwall	
	Pier Cap	
	Bridge Seat	
	Others/Fender Comment on Probing	

**Additional
Remarks:**

Structure No.: XXXX-XXX Route: XXXX Cycle No.: XX
 Name: XXXXXX over XXXXX Creek Insp. Date: MM/DD/YYYY

UNDERWATER DIVING INSPECTION

SUBSTRUCTURE

SI&A Item 60 Condition Rating: _____

PIER _____

RATING	COMPONENT	REMARKS
	Bent	
	Cap	
	Posts/Piles	
	Foundation	
	Cross Bracing	
	Horizontal Bracing	
	Longitudinal Bracing	
	Girts	

**Additional
Remarks:**

Structure No.: XXXX-XXX Route: XXXX Cycle No.: XX
 Name: XXXXX over XXXXX Creek Insp. Date: MM/DD/YYYY

UNDERWATER DIVING INSPECTION

SUBSTRUCTURE

SI&A Item 60 Condition Rating: _____

ABUTMENT _____

RATING	COMPONENT	REMARKS
	Sheeting	
	Piles	
	Pile Cap	
	Wales	
	Header	
	XX Wingwall Sheeting	
	Piles	
	Wales	
	YY Wingwall Sheeting	
	Piles	
	Wales	

**Additional
Remarks:**

Structure No.: XXXX-XXX Route: XXXX Cycle No.: XX
 Name: XXXXX over XXXXX Creek Insp. Date: MM/DD/YYYY

UNDERWATER DIVING INSPECTION

SUBSTRUCTURE
(Arch/Frame)

SI&A Item 60 Condition Rating: _____

ABUTMENT _____

RATING	COMPONENT	REMARKS
	Footings/ Skewbacks	
	Wingwalls/ Retaining Walls	
	Others	

**Additional
Remarks:**

ABUTMENT _____

RATING	COMPONENT	REMARKS
	Footings/ Skewbacks	
	Wingwalls/ Retaining Walls	
	Others	

**Additional
Remarks:**

Structure No.: XXXX-XXX Route: XXXX Cycle No.: XX
 Name: XXXXX over XXXXX Creek Insp. Date: MM/DD/YYYY

UNDERWATER DIVING INSPECTION

SUBSTRUCTURE/SCOUR

SI&A Item 60 Condition Rating: _____

ABUTMENT _____

RATING	COMPONENT	REMARKS
COUNTERMEASURES		
	Description	
	Condition	
PROBING/SCOUR		
	Findings	
	Changes Since Prior Inspection	
	Debris	
Repair Quantities: _____		

ABUTMENT _____

RATING	COMPONENT	REMARKS
COUNTERMEASURES		
	Description	
	Condition	
PROBING/SCOUR		
	Findings	
	Changes Since Prior Inspection	
	Debris	
Repair Quantities: _____		

Structure No.: XXXX-XXX Route: XXXX Cycle No.: XX
 Name: XXXXX over XXXXX Creek Insp. Date: MM/DD/YYYY

UNDERWATER DIVING INSPECTION

SUBSTRUCTURE/SCOUR

SI&A Item 60 Condition Rating: _____

PIERS _____

RATING	COMPONENT	REMARKS
--------	-----------	---------

COUNTERMEASURES

	Description	
	Condition	

PROBING/SCOUR

	Findings	
	Changes Since Prior Inspection	
	Debris	

Repair Quantities: _____

Structure No.: XXXX-XXX Route: XXXX Cycle No.: XX
 Name: XXXXX over XXXXX Creek Insp. Date: MM/DD/YYYY

UNDERWATER DIVING INSPECTION

WATERWAY/CHANNEL

SI&A Item No. 61: _____

SI&A Item No. 71: _____

SI&A Item No. 113: _____

RATING	COMPONENT	REMARKS
FLOW CONDITIONS		
	Direction	
	Magnitude	
	Velocity	
EMBANKMENTS		
	Upstream	
	Downstream	
	Channel Countermeasures	
CHANNEL MOVEMENT AND CHANGES		
	Horizontal Location	
	Cross Section	
	Alignment	
	Changes Since Previous Inspection	
	Navigation Clearances	
	Waterway Opening	
	Other	

Repair
Quantities: _____

CHAPTER 5

OTHER SPECIAL DIVING PROCEDURES

The procedures outlined in Chapters 3 and 4 of this Manual will be utilized in the majority of cases found during Type-1, Type-2 and most Type-3 underwater bridge inspections. However, in some cases, typically in Type-4 Inspections, other procedures which would be outside of the normal scope may be necessary. Should any of these procedures be required, they should be specifically requested of the diving company and an independent cost estimate will be required. These procedures include:

- Underwater photography (still and video)
- Fathometer survey (sections, profiles and contours)
- Special testing for Type 4 (NBIS Level III) inspection

The remainder of this section will provide the basic scope and requirements for each of these procedures.

5.1 UNDERWATER PHOTOGRAPHY

Photographing of an underwater defect on a bridge is often one of the best methods of providing documentation of its extent and location. In addition, it provides a permanent record which can be used to review the conditions found during subsequent inspections. Photography of underwater defects will either be in the form of still photographs or video. The requirements and necessity of the use of each of these methods of photography are as follows:

5.1.1. Still Photography

Still photographs of underwater elements would not normally be required of a Type-2 or Type-3 underwater inspection. If they are to be required of the diving subcontractor, the approximate number should be specifically defined in their scope of work. If it is uncertain or possible that photographs may be required, the scope should allow for a nominal number to be used on an as needed basis.

In cases where a Type-4 underwater inspection is being performed or recommended on a selected element, underwater photographs of the defect are required. In most cases the necessity of the underwater photographs can be based on prior inspection findings.

In all cases, underwater photographs will be paid for based on the number actually included in the final underwater inspection report.

CHAPTER 5 OTHER SPECIAL DIVING PROCEDURES

The photographs shall be made using a 35mm camera and color print film. The color prints shall be included in each copy of the report and shall be 3.5 inches by 5 inches with a glossy finish. The requirements for mounting the photographs in the report are in Section 4.3 of this Manual.

The photographs should be of sufficient clarity to accurately illustrate the defect. When visibility is limited (say less than 1 foot) the necessary lighting and other equipment (such as a clearwater box) will be required. For a full discussion on the types of equipment that are available, refer to Chapter IV of the FHWA's Manual on the Underwater Inspection of Bridges.

5.1.2. Video Photography

At selected sites, a video recording of the underwater defects may be necessary. This could be in cases where the necessity of additional in-depth inspection is being evaluated or where priority repairs have been determined to be required. If video photography is to be required, it should be specifically defined in the scope. If, based on prior inspections, it is thought it may be required, it can be priced as a separate item and utilized on an as needed basis. Payment for video photography shall be lump sum on an individual bridge basis.

The video cassette submitted shall be on High-Grade quality tape in VHS format. The video tape shall be labeled and submitted in a book style plastic case designed to hold VHS tapes and should be similarly labeled. The label should include:

- Bridge Number
- Feature carried
- Waterway name
- County
- Date when video was taken
- Firm performing the underwater inspection

The video recording shall include shots of the above water configuration of the bridge and the substructure elements and the equipment utilized during the dive. The video should have a continuous display of the running time of the tape and the date.

For additional information on equipment, refer to Chapter IV of the FHWA's Manual on the Underwater Inspection of Bridges.

5.2 FATHOMETER SURVEY

A fathometer is a piece of equipment which can be used to measure the channel bottom and monitor scour related activities. It measures the time it takes sound waves to travel through water from a transducer to the channel bottom and reflect back. This time is then converted to water depths, which are displayed on a graphic recorder in the form of a continuous plot of the channel bottom. Since most fathometers are relatively portable, they can be used in large or small boats.

For additional information on fathometers, refer to Chapter VI of the FHWA Manual on the Underwater Inspection of Bridges.

The data from a fathometer is typically presented either in the form of an **individual cross section or profile** at a substructure element or as a **contour map** of an area, including the upstream and downstream channels. The requirements and necessity of the use of each of these methods of survey are as follows:

5.2.1 Individual Cross Section or Profile

In waterway channels which are deep and/or have a swift current, a fathometer can be used to gather the necessary data to prepare the channel cross sections or substructure profiles discussed in Section 3.1 (pages 13-22) of this Manual. This would typically be in cases where a diver is already required to perform a Type-2 or Type-3 Underwater Inspection.

In most cases, the individual profiles or cross sections will be sufficient to determine the structural stability of the foundations.

The format for the final drawings submitted in the report would be the same as that discussed in Section 3.1. Referencing of the readings to fixed point(s) on the bridge is an essential part of the documentation.

In cases where individual cross sections or profiles are to be included in the diver's scope of work, it should be clearly identified and the specific locations of the data required given. It should also be identified if the diver is to merely obtain data points or prepare the actual report drawings. Payment for this item shall be lump sum on an individual bridge basis.

5.2.2 Fathometer Contour Map

A fathometer can also be utilized in the preparation of a topographic survey of the surface of the streambed. This survey provides an accurate picture of the channel bottom including the location and depth of any scour holes. A Fathometer Contour Map would only be recommended in special cases where significant scour is known or expected and the mapping is required to monitor or determine the structural stability of the foundations.

The typical limits of this mapping would be over the entire width of the waterway, including the areas upstream and downstream of the fascias. When required, the scope should include the exact limits of mapping that are necessary. Typically this would include 200 feet upstream and downstream beyond the limits of each fascia.

The scaled drawing prepared should include, but not be limited to, the following:

- 1.) Contour lines drawn to indicate 1 foot changes in elevation of the channel bottom
- 2.) An outline of the bridge's substructure units
- 3.) The location of the fascias of the bridge

Vertical elevations for the channel can be based on an assumed datum, but must be referenced to fixed points on the bridge. The contours should be based on continuous fathometer recordings that are taken based upon a grid established for the site. Typically the grid would be made up of lines which are parallel with the centerline of the bridge and at 20 foot spacings perpendicular to the centerline of the bridge. Additional readings would be required in the area of scour holes to accurately define their horizontal and vertical limits. The proposed methodology used for horizontal and vertical control and the grid to be utilized should be submitted for state's approval prior to the start of the field work.

The services should be performed and the drawing signed by an engineer or surveyor licensed by the State of New Jersey Board of Professional Engineers and Land Surveyors to practice in the State of New Jersey.

The final drawing should be made using Intergraph Microstation (CADD). The final submittal should include a 3-1/2" (90 mm) diskette with the file name, survey date, bridge number and name clearly identified. The information related to fixed elements of the bridge should be inputted on a different layer from the contour information for the channel bottom. The presentation of the drawing should be in general accordance with the preparation of final bridge design plan sheets as indicated in Section 8 of the Department's Design Manual for Bridge's and Structures.

The payment of this item would be on a per bridge lump sum basis which would include all the cost of labor and materials to prepare a contour map of the channel bottom.

5.3 SPECIAL TESTING FOR TYPE 4 INSPECTIONS

As defined in Chapter 2 of this Manual, a Type-4 underwater inspection is a highly detailed inspection of a critical structural element where extensive repair or possible replacement may be warranted. The methods of testing will be dependent upon the types of structural materials and the nature of the defects present.

Typical methods of nondestructive and destructive testing include:

Nondestructive Testing

<u>Material</u>	<u>Testing Method</u>
Steel	<ul style="list-style-type: none">- Ultrasonic thickness measurements- Magnetic particle and radiography for testing of welds
Concrete	<ul style="list-style-type: none">- V-Meter for ultrasonic measurements- Schmidt hammer for measuring compressive strength- R-Meter for measurement of location and size of reinforcing steel
Timber	<ul style="list-style-type: none">- Ultrasonic measurements (similar to V-Meter)

Destructive Testing

<u>Material</u>	<u>Testing Method</u>
Steel	<ul style="list-style-type: none">- Coupons for laboratory testing to determine physical properties
Concrete	<ul style="list-style-type: none">- Coring for laboratory testing to determine physical properties
Timber	<ul style="list-style-type: none">- Coring for laboratory testing to determine physical properties (scope should include plugging of the hole(s) with a treated hardwood dowel)

When the testing methods noted above are to be included in the scope of an underwater inspection, the exact nature and locations for each test should be clearly defined. The

CHAPTER 5
OTHER SPECIAL DIVING PROCEDURES

method of payment can be on a lump sum or a per test amount, depending on the number and nature of the tests required.

For additional information on the types of equipment and tests refer to Chapter V of the FHWA Manual on the Underwater Inspection of Bridges.

Underwater diving inspection services on Department of Transportation bridge inspection projects will be awarded based on a review of technical and cost proposals submitted in

CHAPTER 6 DIVING PROPOSAL FORMAT

response to a request for proposal. The request for proposal will typically be prepared for a project by Department personnel or consultant personnel responsible for one of the Department's bridge inspection contracts.

In cases where a consultant will perform the diving inspection with in-house staff as part of its bridge inspection projects, the technical requirements and costs will be included in the proposal submitted for the bridge inspection efforts.

This Chapter of the Manual will define the format and requirements of the proposal submitted by the diving subconsultant. The proposal will include the following sections:

- 1. Technical Proposal**
 - Scope of Work
 - Key Personnel
 - References

- 2. Cost Proposal**

The following is additional information and the requirements for each of these sections:

6.1 TECHNICAL PROPOSAL

6.1.1 Scope of Work

The general scope of work for a Type-2 or Type-3 Underwater Diving Inspection is provided in Sections 2.1.2 and 2.1.3 (Pages 5 and 6) and Chapter 4 of this Manual. An important aspect of the request for proposal, and an item which is essential to the diving contractor in preparing their estimate, is determining the extent of the bridge elements which are to be inspected and the exact limits of cleaning that will be necessary. This is especially important if different Types of inspection are being performed at the same structure.

The only time the determination of limits for inspection and cleaning information would not be required is in cases when the contract is for on-call or term services. When this is the case, it should be clearly defined and the diving contractor should be given approximate information on the number and type of bridges likely to be included.

CHAPTER 6 DIVING PROPOSAL FORMAT

The diving subcontractor, as part of their Technical Proposal submission, will include a brief description of the equipment and methodology proposed to accomplish the underwater inspection of the bridges or bridge elements included in the scope. The purpose of this technical section is for the reviewer to gain an understanding of the effort which is proposed in comparison to the cost proposal.

The above description should also include:

1. A listing of the major equipment which will be utilized
2. The number of members of the dive team
3. The expected length of time anticipated for the dive
4. The proposed cleaning method (where required)
5. The anticipated schedule for the underwater inspection efforts
6. The amount of time necessary to complete the diving activities
7. The time frame for submission of all preliminary reports

Any qualifications and/or limitations the diving contractor wishes to make based upon the start-up date should also be included. In addition, the diving contractor should identify any equipment to be provided by the engineering consultant.

The diving subcontractor shall be required to provide and maintain insurance as per the limits and requirements of Section 6.3.1 in this Chapter. An affirmative statement regarding the diving contractor's ability to provide this insurance is required in this section. If not provided, the proposal will be rejected as being non-responsive. Insurance certification shall be provided when requested by NJDOT.

Extensive write-ups are not necessary. However, the following three tasks included in Section 4.1 (Pages 30-37) of this Manual should be addressed.

- Task 1 - Office Review
- Task 2 - Field Inspection
- Task 3 - Report Preparation

In addition, the write-up of the approach can include examples of specific past projects which are relevant to the scope.

CHAPTER 6 DIVING PROPOSAL FORMAT

6.1.2 Key Personnel

This section should include specific qualifications and experience for the diver and the on-site individual responsible for the field inspection and the diving contractor's project manager.

The necessary qualifications of these individuals are provided in Section 4.2 (Pages 37-38) of this Manual. The format of the submission is provided as Exhibit 1, located at the end of this Chapter. If the bridge inspection Consultant is required to provide the on-site individual with Team Leader qualifications, it should be clearly stated.

6.1.3 References

The technical proposal section should include references for three specific projects of a similar scope. The reference should be for projects performed within the last three years.

The format for this reference should include the following:

- project name
- agency (or consultant) for whom the project was performed
- year the project was performed
- name and title of reference individual
- telephone number of reference individual

In cases where the project was performed for a consultant as part of a Department of Transportation bridge inspection project, the consultant and not the Department should be listed as the reference individual. Where known, the bridge number(s) and location(s) should be included as part of the project name.

6.2 COST PROPOSAL

The cost proposal will be a firm fixed price to perform **all** the underwater inspection services at the bridges or bridge elements specifically defined in the scope of services. This will include, but not be limited to, all costs necessary to satisfactorily perform the required services such as: dive team and report preparation salaries including travel time, overhead, fixed fee or profit, diver's inspection and personnel protective equipment, supplies, forms, reproduction costs, traveling expenses, insurance, etc.

CHAPTER 6 DIVING PROPOSAL FORMAT

Daily dive team rates and unit prices for items such as underwater photographs, fathometer soundings, etc., may be requested together with the fixed price to establish costs for any additional services, outside of the defined scope, which may be required. Unless specifically requested, proposals which do not provide a total fixed price or provide only a unit price schedule for the items will be rejected as non-responsive.

The Cost proposals will typically be evaluated on a total cost basis. If diving contractor proposals require the bridge inspection consultant to supply personnel for on-site supervision, the evaluation of cost will include the necessary labor, overhead, expenses and fee for these services, as calculated by the bridge inspection consultant. If the bridge inspection consultant cannot supply these services due to contractual limitations, it should be clearly defined in the Request for Proposal Document.

Any qualifications and/or limitations the diving contractor wishes to make regarding the cost, possibly based upon an anticipated start-up or completion dates, should also be included.

6.3 INSURANCE AND OTHER REQUIREMENTS

6.3.1 Insurance Requirements

The diving contractor is required to procure and maintain at its own expense, until at least one year after the completion of all services performed under the contract, liability insurance for damages as imposed by law and assumed as part of the contract. The insurance will be obtained from insurance companies permitted or approved to do business in the State of New Jersey. The insurance that this protection provides, however, does not limit the diving contractor's obligations under the contract and does not limit or relieve them from any liability in excess of the coverage.

When the diving contractor is performing services as part of a bridge inspection consultant's contract, the insurance requirements for the diving contractor will be the same as for the inspection consultant.

Unless otherwise indicated, the types and minimum amounts of insurance are as follows:

A. Comprehensive General Liability Insurance.

The minimum amounts of liability for this insurance shall be as follows:

CHAPTER 6
DIVING PROPOSAL FORMAT

Bodily Injury Liability

<u>Each Occurrence</u>	<u>Aggregate</u>
\$1,000,000	\$2,000,000

Property Damage Liability

<u>Each Occurrence</u>	<u>Aggregate</u>
\$1,000,000	\$2,000,000

The above required Comprehensive General Liability Insurance shall name the State (and the bridge inspection consultant) as an additional insured. The coverage to be provided under this policy shall be at least as broad as the standard, basic, unamended and unendorsed comprehensive general liability policy available in New Jersey and shall include contractual liability coverage. In the event that the above coverage is or may be impaired by claims against the diving contractor, the State (or the bridge inspection consultant), in its sole discretion, may increase the aggregate limits in order to provide the minimum protection as required above.

B. Comprehensive Automobile Liability Insurance.

The Comprehensive Automobile Liability policy shall cover owned, non-owned and hired vehicles with minimum limits as follows:

Bodily Injury Liability

<u>Each Person</u>	<u>Each Occurrence</u>
\$500,000	\$1,000,000

Property Damage Liability

<u>Each Occurrence</u>
\$250,000

C. Workers' Compensation and Employers' Liability Insurance.

CHAPTER 6
DIVING PROPOSAL FORMAT

Workers' Compensation Insurance shall be provided in accordance with the laws of the State of New Jersey and shall include an endorsement to extend coverage to any State which may be interpreted to have legal jurisdiction. Employers' Liability Insurance shall be provided with a limit of liability of not less than \$100,000 for each accident.

D. Professional Liability Insurance.

The diving contractor shall carry Errors and Omissions, Professional Liability and/or Professional Malpractice Insurance sufficient to protect themselves from any liability arising out of professional obligations performed as part of the contract. The insurance shall be in the amount of \$1,000,000 and in such a policy form as shall be approved by the State. Should the diving contractor change carriers during the term of the contract, retroactive coverage shall be obtained for the new insurance carrier.

6.3.2 Compensation Requirements

The method and schedule for payment will be in accordance with procedures agreed upon between the diving contractor and the other contracting party involved. However, the terms and conditions of these items should be clearly spelled out in both the Request for Proposal and the diving contractor's technical and cost proposal. The State will not be a party to such agreements.

**APPENDIX A
REFERENCE DOCUMENTS**

UNDERWATER DIVING INSPECTION QUALIFICATIONS

NAME:

ORGANIZATION:

PROPOSED TITLE FOR THIS PROJECT:

EDUCATION

TYPE OF DEGREE: _____ YEAR _____

ENGINEERING LICENSE: EIT ____ PE ____ YEAR ____ STATE _____

CERTIFICATION: _____ YEAR _____

BRIDGE INSPECTION COURSE TRAINING: _____ YEAR _____

OTHER TRAINING: _____ YEAR _____

SI&A WORKSHOP: YEAR ____ ____ ____

EXPERIENCE

• YEARS IN BRIDGE DESIGN/SPECS ____ ORGANIZATIONS _____

• YEARS IN BRIDGE INSPECTION ____ ORGANIZATIONS _____

• YEARS IN UNDERWATER CONSTRUCTION ____ ORGANIZATIONS _____

• YEARS IN UNDERWATER INSPECTION ____ ORGANIZATIONS _____

APPENDIX A
REFERENCE DOCUMENTS

- "Evaluating Scour at Bridges", Hydraulic Engineering Circular 18; Federal Highway Administration; Publication No. FHWA-IP-90-017; March, 2001.
- "Stream Stability at Highway Structures", Hydraulic Engineering Circular 20; Federal Highway Administration; Publication No. FHWA-IP-90-014; March, 2001.
- "Underwater Inspection of Bridges"; Federal Highway Administration; Publication No. FHWA-DP-80-1; November, 1989.
- "Bridge Inspector's Reference Manual 2002"; Federal Highway Administration; Publication No. FHWA-NHI-03-001; October, 2002.
- "Highways in the River Environment - Participant Notebook"; Federal Highway Administration; Publication No. FHWA-HI-90-016; February, 1990.
- "NJDOT Design Manual - Bridges and Structures"; New Jersey Department of Transportation; 2008.
- "Bridge Scour Evaluation Program - Guidelines Manual for Stage I"; New Jersey Department of Transportation; May, 1991.
- "Recording and Coding Guide for the Structure Inventory and Appraisal of the Nation's Bridges"; Federal Highway Administration; December, 1988.
- "Recording and Coding Guide for the Structure Inventory and Appraisal of New Jersey's Bridges"; New Jersey Department of Transportation; April, 2003.
- Technical Advisory T 5140.21, Revisions to the National Bridge Inspection Standards (NBIS); Federal Highway Administration; September, 1988.

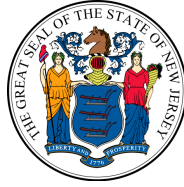

State of New Jersey
NEW JERSEY DEPARTMENT OF TRANSPORTATION
1035 PARKWAY AVENUE
P.O. Box 600
TRENTON, NEW JERSEY 08625-0600

UNDERWATER BRIDGE EVALUATION SURVEY REPORT
OF

STRUCTURE NO.: 0102-034

**ROUTE NJ 456 OVER
PLEASANT BROOK
TOWNSHIP OF GRANT
HUDSON COUNTY**

April 12, 1994

PREPARED BY

DIVING, Inc.
Kearny, New Jersey

DIVING, Inc.

40 Main Street, Kearny, New Jersey 07032
(201) 993-2828 Fax (201) 993-3030

April 28, 1994

Mr. _____, Manager
Structural Evaluation
State of New Jersey
Department of Transportation
1035 Parkway Avenue
PO Box 600
Trenton, New Jersey 08625

Attention: Mr. _____ (Project Manager)

Re: Bridge Underwater Inspection
of Structure No. 0102-034
Route NJ 456 over
South Pleasant Brook
FINAL REPORT SUBMISSION

Dear Mr. _____:

In accordance with our Agreement No. 12BI94 dated March 12, 1994, we are pleased to submit three (3) copies of our final report for the underwater inspection of Bridge Number 0102-034 located in Grant Township, Hudson County.

Our underwater inspection survey has been performed in accordance with the requirements given in Chapter 4 of the Department's Guidelines Manual for the Underwater Inspection of New Jersey's Bridges. However, we cannot ensure that all defects were or could have been disclosed in the course of this survey.

All procedures required by our Quality Assurance Plan for this project have been followed during the work required for the preparation of this report.

Should you have any questions, please do not hesitate to call.

Very truly yours,

_____, P.E.
Project Manager

(Revised: August 2008)

TABLE OF CONTENTS

	<u>Page No.</u>
1 Structural Data	1
2 Summary	1
3 Conclusions and Recommendations	3
4 Soundings and Photographs	4
5 Field Notes	7

**N.J.D.O.T. - STRUCTURAL EVALUATION
UNDERWATER BRIDGE EVALUATION SURVEY REPORT**

STRUCTURAL DATA:

Bridge No.:	0102-034	Year Built:	1958	Widened/ Rehab:	1999
Route No.:	456	Length:	42'	Width:	56.5'
Mile Point:	51.200	Date of this Evaluation:	4/12/1994		
Name:	Route NJ 456 over Pleasant Brook	By:	Diving, Inc.		
Structure Type:	Prestressed concrete I-Beams	Date of Previous Evaluation:	4/25/1990		
		By:	Undersea Diving Co.		

OVERALL CONDITION: Fair.

WORK DONE: None.

SUMMARY:

Number of Substructure Units in Water:	Abutments: 2	Piers: 1
Type of Underwater Inspection:	NJDOT Type-2 on Abutments and Pier	
Underwater Inspection Equipment Used:	Surface supplied air, underwater lights and 2-way radio communications	
Substructure Elements Cleaned:	Center pile of pier cleaned at water and mudline with hand tools	
Water Flow Velocity:	Tidal (Moderate)	Soil Type: Silty sand
Diving Mode:	Surface supplied air.	Dive Team Members: 3
Diving Hazard Analysis / Assessment:	NH- None	
Reference Information:	The previous inspection report was available for review prior to the inspection. Marine growth was light consisting of algae up to 1/16" thick throughout the tidal zone. Visibility was good up to 2 feet.	

Structure No.: 0102-034 Route: 456 Cycle No.: 12
 Name: Route NJ 456 over Pleasant Brook Insp. Date: 4/12/94

COMPONENT / MATERIAL	GENERAL REMARKS
ABUTMENTS (Concrete)	<p><u>North Abutment:</u> The north abutment is in fair condition with a medium sized crack approximately 4' long near center at mudline and light scale at the waterline.</p> <p><u>South Abutment:</u> The south abutment is also in fair condition and has a light scale at the waterline and a large spall approximately 2' x 2' at east and near waterline.</p>
PIER (Steel Pile Bent)	<p><u>Center Pier:</u> The steel piles are in good condition with a ½" thick layer of barnacle growth at the mudline on most piles. The pile surface has lost about 20% of the protective coating over most of its length with the area at the waterline and in the tidal zone having lost 75% of the coating.</p>
PROBING/SCOUR	<p><u>North and South Abutments:</u> No loose sediment or observed scour at either abutment.</p> <p><u>Center Pier:</u> Minor scour of material at east end of center pier with an area of loose sediment and a minor accumulation of wooden debris at same location.</p>
COUNTERMEASURES	Riprap present at both abutments and in good condition. No scour countermeasures in place at the pier.
FENDERS/ BULKHEADS	None.

Structure No.: 0102-034 Route: 456 Cycle No.: 12
Name: Route NJ 456 over Pleasant Brook Insp. Date: 4/12/94

CONCLUSIONS & RECOMMENDATIONS:

The overall condition of the underwater components of the structure is fair due to the medium crack at the north abutment and the large spall at the east end of the south abutment.

Based upon our probing of the streambed materials adjacent to the substructure and our review of the condition of scour countermeasures and prior reports and plans, the bridge appears to have minor potential scour problems. These problems are at the center pier and include minor scour of the channel bed material and an accumulation of debris at east end.

Since the previous underwater inspection the following significant changes have occurred:

1. None.

Due to the conditions observed during our underwater inspection, we recommend the following Priority 3 repairs be made to retard further deterioration, preserve the structural integrity of the bridge, improve safety and extend its useful life:

1. Remove the deteriorated concrete from the spall in the south abutment and patch with epoxy bonded concrete. 10 SF
2. Seal the medium crack in the north abutment by pressure injection with epoxy. 4 LF
3. Apply epoxy coating to the exterior surface areas of the steel pipe pile from the mudline to the high waterline after cleaning the existing marine growth. 80 LF
4. Remove the accumulated debris from the east end of the center pier. 5 CY

In addition, we recommend a Type-2 Underwater Inspection of the bridge be performed on a 4 year interval.

DRAWING(S):

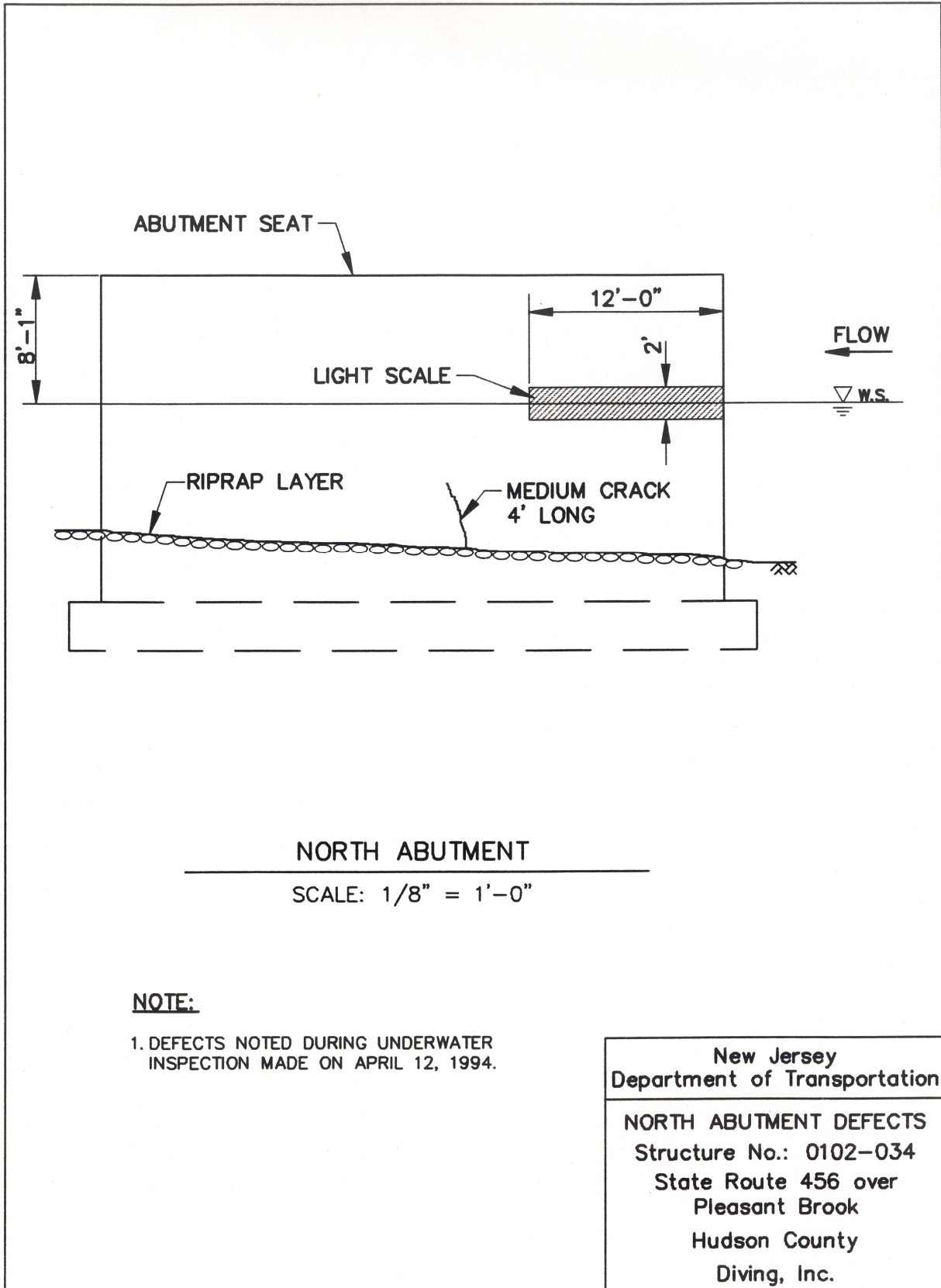

DRAWING(S):

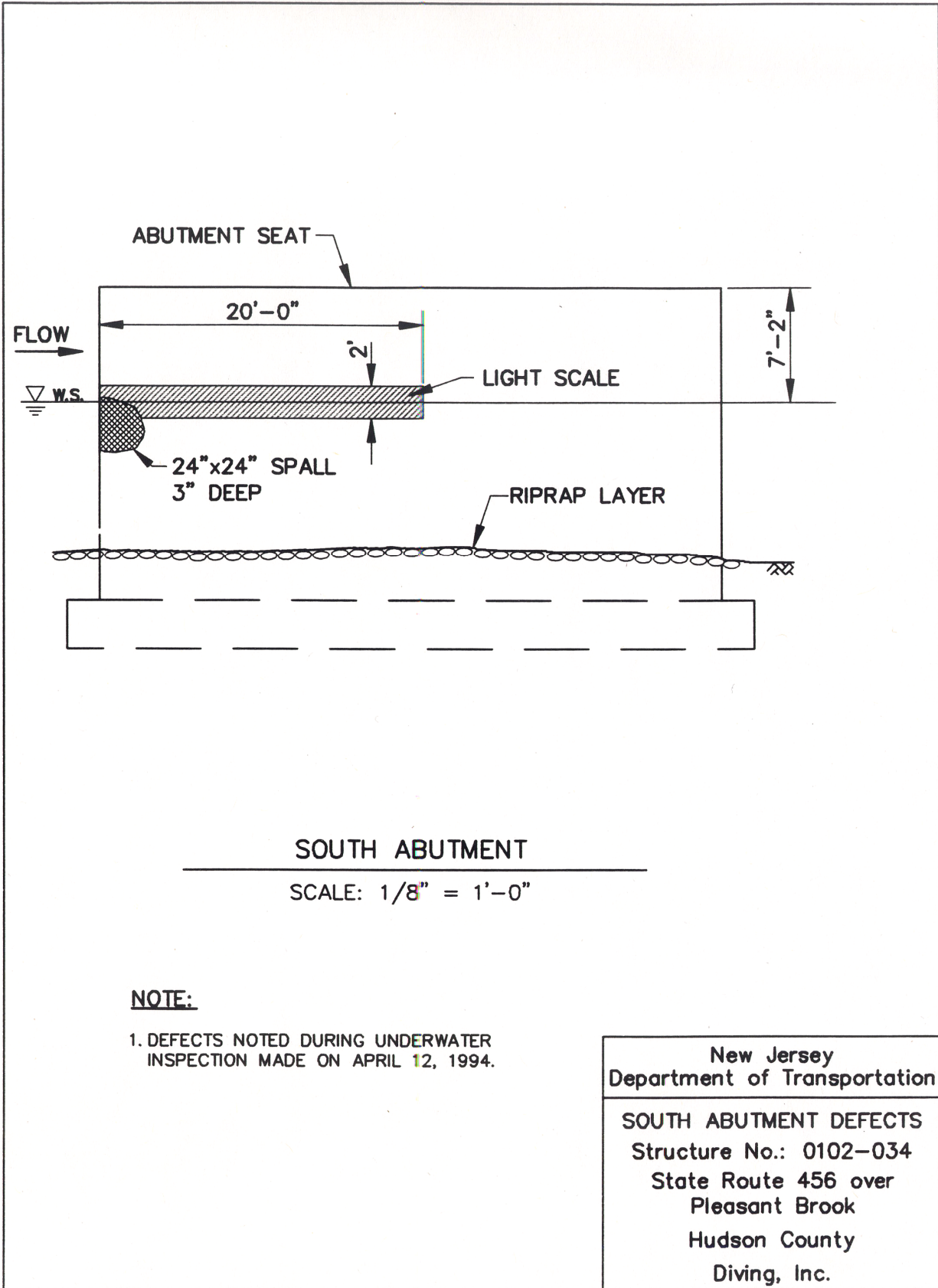

DRAWING(S):

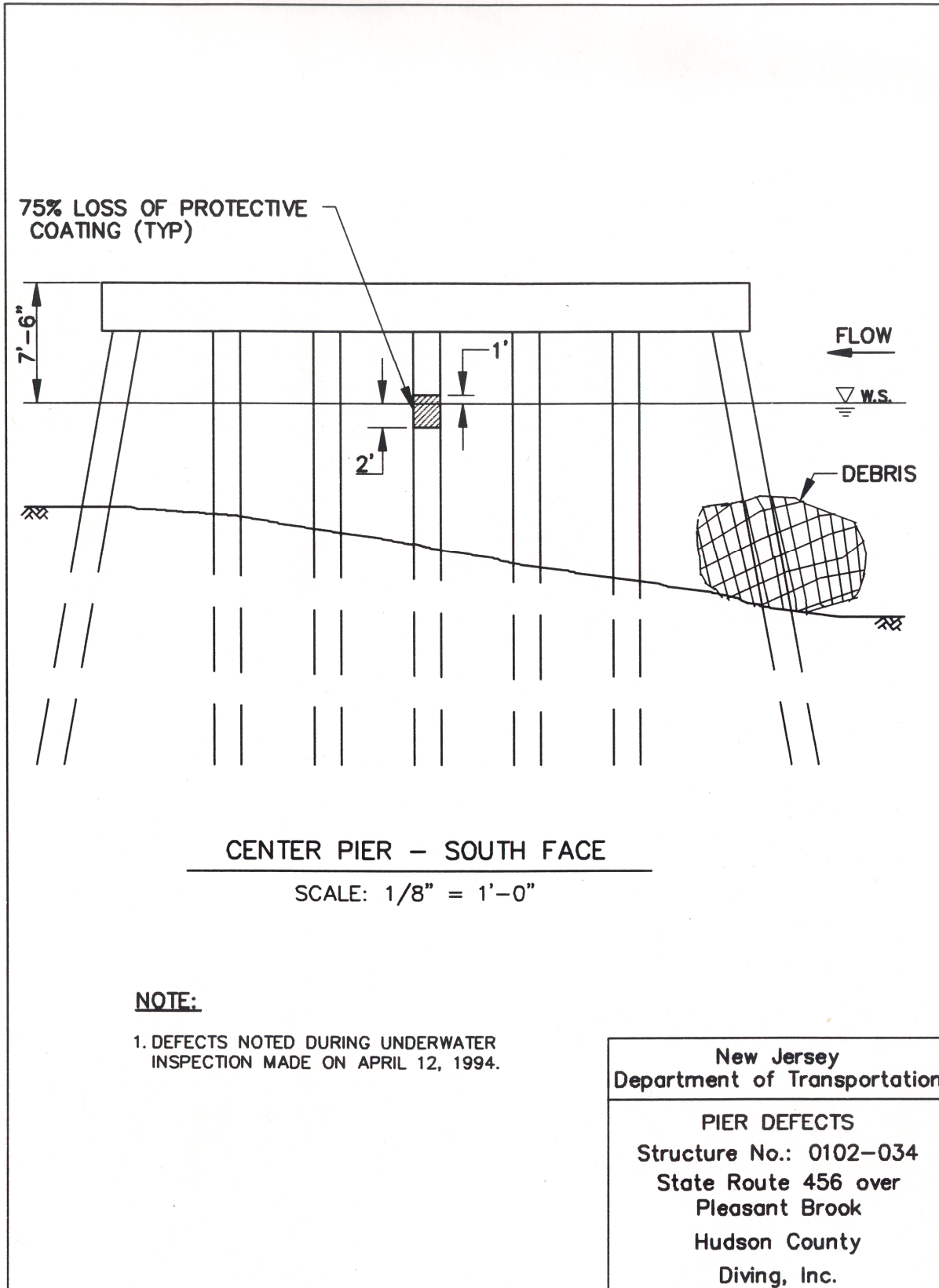

Structure No.: 0102-034 Route: 456 Cycle No.: 12
Name: Route NJ 456 over Pleasant Brook Insp. Date: 4/12/1994

NEW JERSEY DEPARTMENT OF TRANSPORTATION
STRUCTURAL EVALUATION
UNDERWATER DIVING INSPECTION
(FIELD NOTES)

Name: Route NJ 446 over Pleasant Brook
Diver: Warren, Applehoe
Company: Diving, Inc.
Team leader: Philip, Connor
Company: Diving, Inc.
Temperature: 55° F Weather: Partly Cloudy
Equipment Used: Surface supplied air, underwater lights, 2-way radio for communication

RATINGS:

- N Not applicable
- 9 Excellent Condition
- 8 Very Good Condition – no problems noted.
- 7 Good Condition – some minor problems.
- 6 Satisfactory Condition – some minor deterioration of structural elements.
- 5 Fair Condition – minor section loss of primary structural elements.**
- 4 Poor Condition – advance section loss of primary structural elements.
- 3 Serious Condition – seriously deteriorated primary structural elements.
- 2 Critical Condition – facility should be closed until repairs are made.
- 1 Imminent Failure Condition – facility closed. Study of repairs is feasible.
- 0 Failed Condition – facility is closed and beyond repair.

GENERAL

Type of Bridge: Prestressed Concrete I-Beams
Type of Substructure: Full-height concrete abutments, 7 pile steel pile bent with reinforced concrete pile cap at center pier
No. of Lanes: On 2 Under Waterway
Number of substructure units in water: Abutments: 2 Piers: 1
Overall condition of substructure: Fair due to the condition of substructure

WATERWAY:

Type: Tidal Inlet Velocity: Moderate
Streambed material: Silty sand

UNDERWATER DIVING INSPECTION

SUBSTRUCTURE

SI&A Item 60 Condition Rating: 5

ABUTMENT NORTH

RATING	COMPONENT	REMARKS
5	Breastwall (Concrete)	Fair condition; light scale at waterline in a 12' x 2' area on east half; 4' long medium longitudinal crack at mudline near center of pier.
N	Backwall	Not visible.
N	Bridge Seat	Not visible.
8	Wingwalls/ Retaining Walls (Concrete)	Good condition, no deterioration noted.
7	Embankment / Slope Protection	
7	Others / Footings / Waterway Probing	Not visible; covered with sediment and riprap.

**Additional
Remarks:**

Crack 4 LF

UNDERWATER DIVING INSPECTION

SUBSTRUCTURE

SI&A Item 60 Condition Rating: 5

ABUTMENT SOUTH

RATING	COMPONENT	REMARKS
5	Breastwall (Concrete)	Fair condition; light scale at waterline in a 20' x 2' area on east half; large spall (2' x 2' x 3") at east end near waterline.
N	Backwall	Not visible.
N	Bridge Seat	Not visible.
8	Wingwalls/ Retaining Walls (Concrete)	Good condition, no deterioration noted.
7	Embankment / Slope Protection	
7	Others / Footings / Waterway Probing	Not visible; covered with sediment and riprap.

Additional Small repair 10 SF
Remarks: _____

UNDERWATER DIVING INSPECTION

SUBSTRUCTURE

SI&A Item 60 Condition Rating: 5

PIER CENTER

RATING	COMPONENT	REMARKS
7	Columns/ Stem Crashwall (Steel Pipe)	Good condition; protective coating is being worn away, abutment 20% over most of length of pile, with up to 75% loss of coating in tidal area.
8	Pier Cap (Concrete)	Good condition, no deterioration noted.
7	Bridge Seat (Concrete)	
6	Others/Fender Comment on Probing	Moderate accumulation of debris at east end of bent.

Additional Remarks:	Replace protective coating	80 LF
	Remove debris	5 CY

UNDERWATER DIVING INSPECTION

SUBSTRUCTURE/SCOUR

SI&A Item 60 Condition Rating: 5

ABUTMENT NORTH

RATING	COMPONENT	REMARKS
--------	-----------	---------

COUNTERMEASURES

	Description	Stone riprap along whole length. Approx. 6" diameter stone.
8	Condition	Good condition; full coverage of abutment footing.

PROBING/SCOUR

8	Findings	No scour noted at abutment; no loose sediment.
	Changes Since Prior Inspection	None.
8	Debris	None.

Repair Quantities: None.

ABUTMENT SOUTH

RATING	COMPONENT	REMARKS
--------	-----------	---------

COUNTERMEASURES

	Description	Stone riprap along whole length. Approx. 6" diameter stone.
8	Condition	Good condition; full coverage of abutment footing.

PROBING/SCOUR

8	Findings	No scour noted at abutment; no loose sediment.
	Changes Since Prior Inspection	None.
8	Debris	None.

Repair Quantities: None.

Structure No.: 0102-034 Route: 456 Cycle No.: 12
 Name: Route NJ 456 over Pleasant Brook Insp. Date: 4/12/1994

UNDERWATER DIVING INSPECTION

SUBSTRUCTURE/SCOUR

SI&A Item 60 Condition Rating: 5

PIERS CENTER

RATING	COMPONENT	REMARKS
--------	-----------	---------

COUNTERMEASURES

	Description	None.
N	Condition	N/A

PROBING/SCOUR

7	Findings	East end minor scour of streambed material and area of loose sediment.
	Changes Since Prior Inspection	None.
6	Debris	Moderate accumulation of wooden debris at east end of pier.

Repair Quantities: Remove debris 5 CY

SAMPLE
REQUEST FOR PROPOSAL

ALLIED CONSULTANTS, INC.

693 Broad Street
Hackensack, New Jersey 08937
Tel (201) 448-3862 Fax (201) 448-0592

February 1, 1994

Diving, Inc.
40 Main Street
Kearny, New Jersey 07032

Attn: Mr. Christopher Paul, P.E.

Re: Bridge Survey
70 Off-System Hudson County Bridges
Underwater Diving Inspection

Dear Mr. Paul:

Allied Consultants, Inc. has been retained by the New Jersey Department of Transportation to provide professional engineering services for the inspection of 70 Hudson County Off-System bridges. The inspection of the bridge below will require an underwater diving inspection:

0102-034 Route NJ 456 over Pleasant Brook

With this letter, we are soliciting bids for providing the underwater inspection and report of findings for the listed structure. The requirements and other salient facts are attached to this letter.

Proposals are due by March 1, 1994. The proposal shall include the following sections:

- , Scope of Work
- , Key Personnel
- , References
- , Cost Proposal

Additional information and requirements of each of these items are contained in Chapter 6 of the Underwater Inspection and Evaluation of New Jersey Bridges Guidelines Manual. The insurance requirements will be the same as those listed in Section 6.3.1.

If you have any questions or need additional information, please do not hesitate to call.

Very truly yours,

Allied Consultants, Inc.

Terence Esterhaus, P.E.
Vice President

**BRIDGE SURVEY - 70 OFF-SYSTEM
HUDSON COUNTY BRIDGES
UNDERWATER DIVING INSPECTION**

LOCATION

Structure No. 0102-034 carries Route NJ 456 over Pleasant Brook in the Township of Grant.

SCOPE OF SERVICES

Structure No. 0102-034 will require a Type-2 inspection, as described in Chapter 2, Section 2.1.2, of the Manual of both abutments and the center pier. The inspection will adhere to the scope of work and procedures described in Chapter 4 of the Manual.

Based upon prior underwater inspections, marine growth is present on the piles of the center pier. For purposed of estimating, the center pile will be cleaned at the waterline and mudline locations for a band width of approximately 10 inches over 75% of the circumference of the pile.

SAMPLE
TECHNICAL AND COST PROPOSAL

DIVING, Inc.

40 Main Street, Kearny, New Jersey 07032
(201) 993-2828 Fax (201) 993-3030

February 17, 1994

Allied Consultants, Inc.
693 Broad Street
Hackensack, New Jersey

Attn: Mr. Terence Esterhaus, P.E.

Re: Underwater Inspection
of Structure No. 0102-034
Route NJ 456 over Pleasant Brook

Dear Mr. Esterhaus:

As per your request, we are pleased to submit our proposal for the above referenced services.

Based upon the Scope of Work as outlined in your request for proposal for a Type-2 Underwater Inspection and Chapter 4 of the Guidelines Manual for the Underwater Inspection and Evaluation of New Jersey Bridges, the price for performing the inspection is \$1,500.00. This cost includes a licensed diver, tender (one of whom will be a licensed Professional Engineer in the State of New Jersey), diving equipment, boat, transportation, insurance and report preparation.

Attached is our scope of work, list of key personnel, references and tabulated cost proposal.

If you have any questions or require additional information, please do not hesitate to call.

Very truly yours,

Christopher Paul, P.E.
Project Manager

TECHNICAL PROPOSAL

SCOPE OF WORK

As outlined in Chapter 4 of the Underwater Inspection and Evaluation of New Jersey Bridges Guidelines Manual, the Scope of Work will include three (3) tasks.

! Task 1 - Office Review

This will include an office review of bridge plans and any prior underwater inspection surveys of the substructure elements to be inspected. This review will be based upon information supplied by Allied Consultants, Inc. and will be performed before the dive operation commences.

! Task 2 - Field Inspection

This task will involve cleaning and inspection of the underwater portion of the abutments and center pier of Structure No. 0102-034, Route NJ 456 over Pleasant Brook.

Physical cleaning of the abutments is not required based upon prior inspections. Cleaning at the center pier will be performed over a 10" band width over a 75% area of the circumference at the waterline and mudline. The cleaning will be performed by hand tools and the use of high pressure water is not anticipated to be required.

A Type-2 inspection will be performed on the abutments and piles. Observations on scour related defects will also be recorded. The inspection will be performed using surface supplied air. Underwater lights and 2-way radios will be required. It is anticipated that the diving activities will be completed in five (5) hours on the day of the inspection. There will be two (2) members of the dive team.

! Task 3 - Report Preparation

In accordance with Section 4.3 of the Department's Manual, an Underwater Bridge Evaluation Survey Report will be prepared and submitted for comments. Upon approval, three (3) copies of the Final Report will be submitted.

SCHEDULE

Once the notice to proceed is given by Allied Consultants, Inc., all diving activities will be completed within two weeks and the Preliminary Report will be submitted within one month.

INSURANCE

Our insurance coverages exceed the limits for comprehensive general liability insurance, comprehensive automobile liability insurance, workers' compensation and employers' liability insurance and professional liability insurance. Certification of these insurance coverages will be provided upon request by NJDOT.

KEY PERSONNEL

The following individuals will be assigned to this project.

Project Manager : Christopher Paul

Team Leader : Philip Connor

Underwater Inspector : Warren Applehoe

The qualifications of these individuals are provided on the attached forms.

UNDERWATER DIVING INSPECTION QUALIFICATIONS

NAME: Christopher Paul

ORGANIZATION: Diving, Inc.

PROPOSED TITLE FOR THIS PROJECT: Project Manager

EDUCATION

TYPE OF DEGREE: B.S. Civil Engineering YEAR 1975

ENGINEERING LICENSE: EIT _____ PE X YEAR 1982 STATE NJ

CERTIFICATION: Divers Academy of the Eastern Seaboard YEAR 1979

BRIDGE INSPECTION COURSE TRAINING: NBIS YEAR 1992

OTHER TRAINING: U.S.C.G.- Licensed Ten Ton Boat Operator YEAR 1974

SI&A WORKSHOP: YEAR _____

EXPERIENCE

EXPERIENCE

• YEARS IN BRIDGE DESIGN/SPECS _____ ORGANIZATIONS _____

• YEARS IN BRIDGE INSPECTION _____ ORGANIZATIONS _____

• YEARS IN UNDERWATER CONSTRUCTION _____ ORGANIZATIONS _____

• YEARS IN UNDERWATER INSPECTION 10 ORGANIZATIONS Diving, Inc

UNDERWATER DIVING INSPECTION QUALIFICATIONS

NAME: Philip Connor

ORGANIZATION: Diving, Inc.

PROPOSED TITLE FOR THIS PROJECT: Team Leader

EDUCATION

TYPE OF DEGREE: B.S. Civil Engineering YEAR 1970

ENGINEERING LICENSE: EIT _____ PE X YEAR 1982 STATE NJ

CERTIFICATION: _____ YEAR _____

BRIDGE INSPECTION COURSE TRAINING: NBIS YEAR 1992

OTHER TRAINING: EMT YEAR 1980

SI&A WORKSHOP: YEAR 1993 _____

EXPERIENCE

• YEARS IN BRIDGE DESIGN/SPECS _____ ORGANIZATIONS _____

• YEARS IN BRIDGE INSPECTION 4 ORGANIZATIONS NJDOT

• YEARS IN UNDERWATER CONSTRUCTION 5 ORGANIZATIONS U.S. Navy

• YEARS IN UNDERWATER INSPECTION 10 ORGANIZATIONS Diving, Inc.

UNDERWATER DIVING INSPECTION QUALIFICATIONS

NAME: Warren Applehoe

ORGANIZATION: Diving, Inc.

PROPOSED TITLE FOR THIS PROJECT: Underwater Inspector

EDUCATION

TYPE OF DEGREE: B.S. Civil Engineering Technologies YEAR 1986

ENGINEERING LICENSE: EIT _____ PE _____ YEAR _____ STATE _____
CERTIFICATION: Divers Academy of the Eastern Seaboard YEAR 1988

BRIDGE INSPECTION COURSE TRAINING: NHI Course #130055 YEAR 2008

OTHER TRAINING: Civil Defense SCUBA Rescue Squad YEAR 1987

SI&A WORKSHOP: YEAR _____

EXPERIENCE

EXPERIENCE

• YEARS IN BRIDGE DESIGN/SPECS _____ ORGANIZATIONS _____

• YEARS IN BRIDGE INSPECTION _____ ORGANIZATIONS _____

• YEARS IN UNDERWATER CONSTRUCTION 2 ORGANIZATIONS Diving, Inc

• YEARS IN UNDERWATER INSPECTION 6 ORGANIZATIONS Diving, Inc

REFERENCES

Underwater Inspection of Three (3) Movable Salem County Bridges, Structure Nos: 1201-111, 1201-112, 1201-123.

Client: Morris Consultants, Inc.
Year: 1992
Contact Person: Edward James, Project Manager
Telephone No.: (203) 777-9653

Underwater Inspection of Two (2) State Bridges, Structure Nos: 0654-153 and 1510-123.

Client: The Traveling Company
Year: 1993
Contact Person: Charles Traveler, Vice President
Telephone No.: (215) 770-9679

Underwater Inspection of Two (2) State Bridges, Structure Nos: 1793-152 and 1724-150.

Client: C. M. Hunch, Co.
Year: 1994
Contact Person: C. M. Hunch, President
Telephone No.: (604) 482-3653

**BRIDGE SURVEY - 70 OFF-SYSTEM
HUDSON COUNTY BRIDGES
UNDERWATER DIVING INSPECTION**

COST PROPOSAL

Service Description	Quantity	Unit	Unit Price	Amount
Type-2 Underwater Inspection for Structure No. 0102-034	1	Each	\$1,500.00	\$1,500.00
Total				\$1,500.00